

Public

**Common Criteria
Information Technology
Security Evaluation**

Project Crow

**Security Target Lite of
Samsung S3CT9KW
16-bit RISC Microcontroller
for Smart Card with
optional Secure RSA and ECC Library
including specific IC Dedicated Software**

Version 1.0

31th March 2010



ELECTRONICS

REVISION HISTORY

UPDATES:

Version	Date	Modification
1.0	31 th March 2010	Creation

WRITERS:

Written by	Title
SG Park	Engineer

CONTENTS

1	ST INTRODUCTION	4
1.1	SECURITY TARGET AND TOE REFERENCE.....	4
1.2	TOE OVERVIEW AND TOE DESCRIPTION	4
1.3	INTERFACES OF THE TOE	11
1.4	TOE INTENDED USAGE	11
2	CONFORMANCE CLAIMS	13
2.1	CC CONFORMANCE CLAIM	13
2.2	PP CLAIM	13
2.3	PACKAGE CLAIM	13
2.4	CONFORMANCE CLAIM RATIONALE.....	13
3	SECURITY PROBLEM DEFINITION	15
3.1	DESCRIPTION OF ASSETS	15
3.2	THREATS	16
3.3	ORGANIZATIONAL SECURITY POLICIES	21
3.4	ASSUMPTIONS	22
4	SECURITY OBJECTIVES.....	25
4.1	SECURITY OBJECTIVES FOR THE TOE	25
4.2	SECURITY OBJECTIVES FOR THE SECURITY IC EMBEDDED SOFTWARE DEVELOPMENT ENVIRONMENT.....	28
4.3	SECURITY OBJECTIVES FOR THE OPERATIONAL ENVIRONMENT.....	30
4.4	SECURITY OBJECTIVES RATIONALE	30
5	EXTENDED COMPONENTS DEFINITION.....	33
5.1	DEFINITION OF THE FAMILY FCS_RNG.....	33
5.2	DEFINITION OF THE FAMILY FMT_LIM.....	34
5.3	DEFINITION OF THE FAMILY FAU_SAS.....	35
6	IT SECURITY REQUIREMENTS	37
6.1	SECURITY FUNCTIONAL REQUIREMENTS FOR THE TOE.....	37
6.2	TOE ASSURANCE REQUIREMENTS.....	49
6.3	SECURITY REQUIREMENTS RATIONALE.....	50
7	TOE SUMMARY SPECIFICATION.....	59
7.1	LIST OF SECURITY FUNCTIONAL REQUIREMENTS	59
8	ANNEX	64
8.1	GLOSSARY.....	64
8.2	ABBREVIATIONS	66
8.3	LITERATURE.....	67

1 ST INTRODUCTION

2 This introductory chapter contains the following sections:

- 1.1 Security Target and TOE Reference
- 1.2 TOE Overview and TOE Description
- 1.3 Interfaces of the TOE
- 1.4 TOE Intended Usage

1.1 Security Target and TOE Reference

3 The Security Target version is 1.0 and dated 31th March 2010

4 The Security Target is based on

[5] Eurosmart Security IC Platform Protection Profile, Version 1.0, June 2007, BSI-PP-0035.

5

6 The Protection Profile and the Security Target are built on *Common Criteria version 3.1*.

- Title: Security Target of S3CT9KW 16-Bit RISC Microcontroller for Smart Cards
- Target of Evaluation: S3CT9KW revision 0
- Provided by: Samsung Electronics Co., Ltd.
- Common Criteria version :

[1] Common Criteria, Part 1: Common Criteria for Information Technology Security Evaluation, Part 1: Introduction and General Model, Version 3.1, Revision 3, July 2009, CCMB-2009-07-001

[2] Common Criteria, Part 2: Common Criteria for Information Technology Security Evaluation, Part 2: Security Functional Components, Version 3.1, Revision 3, July 2009, CCMB-2009-07-002

[3] Common Criteria, Part 3: Common Criteria for Information Technology Security Evaluation, Part 3: Security Assurance Components, Version 3.1, Revision 3, July 2009, CCMB-2009-07-003

[4] Common Methodology for Information Technology Security Evaluation, Evaluation Methodology, Version 3.1, Revision 3, July 2009, CCMB-2009-07-004

1.2 TOE Overview and TOE Description

1.2.1 Introduction

7 The Target of Evaluation (TOE), the S3CT9KW microcontroller featuring the TORNADO™2MX2 cryptographic coprocessor, is a smartcard integrated circuit which is composed of a processing unit, security components, contactless and contact based I/O ports, hardware circuit for testing purpose during the manufacturing process and volatile and non-volatile memories (hardware). The TOE also includes any IC Designer/Manufacturer proprietary IC Dedicated Software as long as it physically exists in the smartcard integrated circuit after being delivered by the IC Manufacturer. Such software (also known as IC firmware) is used for testing purpose during the manufacturing process but also provides additional services to facilitate the usage of the hardware and/or to provide additional services, including optional RSA/ECC asymmetric cryptography library, an [7]AIS20 compliant random number generation library and an [6]AIS31 compliant random number generator. The RSA/ECC library further includes the functionality of hash computation. The use for keyed hash operations like HMAC or similar security critical operations involving keys and other secrets, is not subject of this TOE and requires specific security improvements and DPA analysis including the

operating system, which is not part of this TOE. However, this functionality is intended to be used for signature generation and verification only. All other software is called Smartcard Embedded Software and is not part of the TOE.

- 8 Regarding the RSA and ECC library the user has the possibility to tailor this IC Dedicated Software part of the TOE during the manufacturing process by deselecting the RSA and ECC library. Hence the TOE can be delivered with or without the functionality of the RSA and ECC library what's resulting in two TOE configurations. This is considered in this Security Target and corresponding notes (indicated by "optional") are added where required. If the user decides not to use the RSA/ECC crypto library, the library is not delivered to the user and the accompanying "Additional Specific Security Functionality (O.Add-Functions)" Rivest-Shamir-Adleman (RSA) and Elliptic Curve Cryptography (ECC) is not provided by the TOE. Deselecting RSA and ECC library means excluding the code implementing functionality, which the user decided not to use. Excluding the code of the deselected functionality has no impact on any other security policy of the TOE, it is exactly equivalent to the situation where the user decides just not to use the functionality.

1.2.2 TOE Definition

- 9 The S3CT9KW single-chip CMOS micro-controller is designed and packaged specifically for "Smart Card" applications.
- 10 The CalmRISC16 CPU architecture of the S3CT9KW microcontroller follows the Harvard style, that is, it has separate program memory and data memory. Both instruction and data can be fetched simultaneously without causing a stall, using separate paths for memory access.
- 11 The main security features of the S3CT9KW integrated circuit are:
- Security sensors or detectors including High and Low Temperature detectors, High and Low Frequency detectors, High and Low Supply Voltage detectors, Supply Voltage Glitch detectors, Light detector and the Passivation Removing Detector
 - Active Shields against physical intrusive attacks
 - Dedicated tamper-resistant design based on synthesizable glue logic and secure topology
 - Dedicated hardware mechanisms against side-channel attacks such as Internal Variable Clock, Random Current Generator, Random Waits Generator, RAM and EEPROM encryption mechanisms
 - Secure DES and AES Symmetric Cryptography support
 - Secure TORNADO™2MX2 coprocessor for RSA and ECC Asymmetric Cryptographic Support
 - The IC Dedicated Software includes:
 - A modular arithmetic library for RSA and ECC (with SHA) Asymmetric Cryptography support (optional)
 - A Deterministic Random Number Generator (DRNG) for AIS20-compliant Random Number Generation
 - A True Random Number Generator (TRNG) for AIS31-compliant Random Number Generation
- 12 The main hardware blocks of the S3CT9KW Integrated Circuit are described in **Figure 1** below:

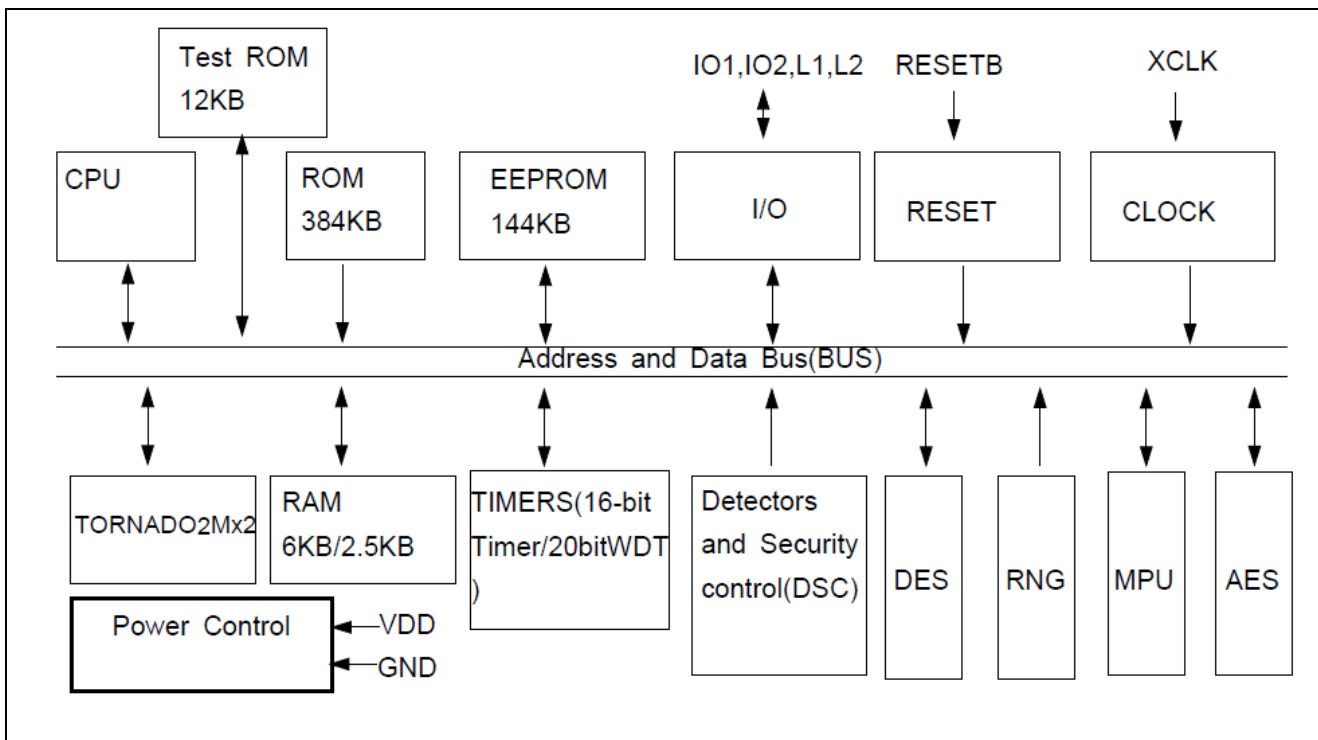

Figure 1. S3CT9KW Block Diagram

13 *Note that only the Triple DES algorithm belongs to the TOE, not the Single DES.

14 The TOE consists of the following Hardware and Software:

TOE Hardware

- 144K bytes EEPROM/6K bytes RAM/2.5K bytes Crypto. RAM/384K User ROM/12K Test ROM
- 16-bit Central Processing Unit (CPU)
- Internal Voltage Regulator (IVR)
- Detectors & Security Logic
- A True random number generator (TRNG)
- A deterministic random number generator (DRNG)
- Memory Protection Unit (MPU)
- Triple DES cryptographic coprocessor with 112 or 168 bits key size
- AES cryptographic coprocessor with 128 bits, 192bits and 256bits key size
- TORNADO™2MX2 supporting up to 2048-bit RSA and 512-bit ECC key size
- Hardware UART for contact and contactless I/O modes
- Address & data buses
- Internal Clock
- Timers

TOE Software

15 The TOE software comprises the following components:

- Test ROM code that is used for testing the chip during production
- The TORNADO™2MX2 Secure RSA/ECC library v1.0 (optional)
TORNADO™2MX2 is Hardware coprocessor for high speed modular multiplications, modular additions and modular subtractions.
The TORNADO™2MX2 Secure RSA/ECC library v1.0 is a software library built on the TORNADO™2MX2 coprocessor that provides high level interface for RSA and ECC cryptographic algorithms.
The RSA functions of the library included in the TOE are:
 - TND_RSA_SigSTD_Secure (RSA signature generation)
 - TND_RSA_SigCRT_Secure (RSA signature generation with CRT method)
 - TND_RSA_Verify (RSA signature verification)

The functions TND_RSA_SigSTD_Secure and TND_RSA_SigCRT_Secure have some countermeasure against SPA, DPA and DFA attacks.

The TORNADO™2MX2 Secure RSA/ECC library provides a set of functions to implement elliptic curve cryptography algorithms. In particular it provides some functions to implement ECDSA signature and ECDH key exchange protocols. The library implements ECC for prime field and general curve for bit size from 192 bits to 512 bits and the only certain curves are in the scope of this evaluation. The ECC functions of the library included in the TOE are:

- ECDSA_keygen (Generate ephemeral or static key pairs for ECDSA signature generation or ECDH key agreement)
- ECDSA_sign_digest (ECDSA signature generation of a digest message byte string)
- ECDSA_verify_digest (ECDSA signature verification of a digest message byte string)
- ECDH_generate (ECDH key agreement)

The functions ECDSA_keygen and ECDSA_sign_digest have some countermeasure against SPA, DPA and DFA. The function ECDSA_verify_digest has some countermeasure against DFA. The function ECDH_generate can be used with ephemeral or static private keys. It has some countermeasure against SPA, DPA and DFA for protecting the private key. The base point is assumed to be public.

Note1) The RSA/ECC library supports any valid elliptic curves over prime fields of size 192-bit to 512-bits. However, standard curves listed below whose security has been proven are in the scope of this evaluation.

1) *[NIST curves]* : Curves P-192, P-224, P-256, P-384

2) *[Brainpool curves]*: brainpoolP192r1, brainpoolP192t1, brainpoolP224r1,
brainpoolP224t1, brainpoolP256r1, brainpoolP256t1, brainpoolP320r1,
brainpoolP320t1, brainpoolP384r1, brainpoolP384t1, brainpoolP512r1,
brainpoolP512t1

3) *[SEC-recommended curves]*: secp192k1, secp192r1, secp224k1, secp224r1, secp256k1,
secp256r1, secp384r1

The TORNADO™2MX2 Secure RSA/ECC library provides the following functions for calculating hash (digest) values using the SHA1, SHA224, SHA256, SHA384 and SHA 512 algorithm as specified in [FIPS PUB 180-3], but, only functions related to SHA224, SHA256,

SHA384 and SHA 512 are within the scope of this evaluation:

- SHA1_init, SHA1_update, SHA1_final,
- SHA224_init, SHA224_update, SHA224_final,
- SHA256_init, SHA256_update, SHA256_final.
- SHA384_init, SHA384_update, SHA384_final.
- SHA512_init, SHA512_update, SHA512_final.

These functions are not security relevant functions, i.e. they must not be used to hash security values like keys etc. There are implemented no countermeasures against side channel attacks. The TOE provides the functionality of hash computation if and only if the optional TORNADO™2MX2 Secure RSA/ECC library is delivered.

- A Deterministic Random Number Generator (DRNG) that fulfills the requirements of *AIS 20*, Class K3.
- A True Random Number Generator (TRNG) that fulfills the requirements of *AIS 31*, Class P2.

16 The TOE configuration is summarized in table 1 below:

Item Type	Item	Version	Form of delivery
Hardware	S3CT9KW 16-Bit RISC Microcontroller for Smart Card	0	Wafer or Module
Software	Test ROM Code	1.0	Included in S3CT9KW Test ROM
Software (optional)	Secure RSA/ ECC Library	1.0	Software Library
Software	DRNG	1.0	Software Library
Software	TRNG	1.0	Software Library
Document	RSA/ECC Application Note	1.09	Softcopy
Document	DRNG Application Note	1.0	Softcopy
Document	TRNG Application Note	1.0	Softcopy
Document	Hardware User's manual	0.2	Softcopy
Document	Security Application Note	1.7	Softcopy
Document	Delivery Specification	0.3	Softcopy
Document	Architecture Reference: SecuCalm16 CPU Core	0.3	Softcopy

Table 1. TOE Configuration

17 Note: The TOE can be delivered without the RSA/ECC crypto library. In this case the TOE does not provide the Additional Specific Security Functionality Rivest-Shamir-Adleman Cryptography and Elliptic Curve Cryptography (ECC) and Secure Hash Algorithm (SHA).

1.2.3 TOE Features

CPU

- 16-bit SecuCalm core

Memory

- 384K-byte Program Memory (ROM)
- 12K- byte Test ROM
- 144K-byte Data/Program Memory (EEPROM)
- 6K-byte Data Memory (RAM)
- 2.5K-byte Crypto Memory (Crypto RAM)

EEPROM Write Operations

- Min. 500,000 write/erase cycles
- Data retention for min. 10 years

Triple DES

- Built-in hardware Triple DES accelerator
- Circuit for resistance against SPA and DPA attacks

AES

- Built-in hardware AES accelerator
- Circuit for resistance against SPA and DPA attacks

Abnormal Condition Detectors

- Abnormal Voltage/Frequency/Light/Temperature detectors
- Power glitch detector
- Inner insulation removal detector
- Active shield removal detector

Interrupts

- Two interrupt sources and vectors (FIQ,IRQ)

Serial I/O Interface

- UART for handling serial I/O interface in accordance with the ISO 7816 communication protocols
- Type A and Type B contactless interfaces compliant with the ISO 14443 standard

Reset and Power Down Mode

- Stop mode

Random Number Generator

- A True random number generator (TRNG)
- A deterministic random number generator (DRNG)

Memory Protection Unit

The MPU allow the CPU to access memories through channels. Each channel can allow the access to a contiguous range of address.

Memory Encryption and Bus Scrambling

- Bus scrambling and Memory encryption

Timers

- 16-Bit Timer
- 20-bit Watchdog Timer

Clock Sources

- External clock: 1 MHz-5 MHz

Operating Voltage Range

- 1.62 V - 5.5 V

Operating Temperature

- - 25°C to 85°C

Package

- Wafer
- 8-pin COB (compliant with ISO 7816)

1.2.4 TOE Life cycle

18 The complex development and manufacturing processes of a Composite Product can be separated into seven distinct phases. The phases 2 and 3 of the Composite Product life cycle cover the IC development and production:

- IC Development (Phase 2):
 - IC design,
 - IC Dedicated Software development,
- the IC Manufacturing (Phase 3):
 - integration and photomask fabrication,
 - IC production,
 - IC testing,
 - preparation and
 - Pre-personalisation if necessary

The Composite Product life cycle phase 4 can be included in the evaluation of the IC as an option:

- the IC Packaging (Phase 4):
 - Security IC packaging (and testing),
 - Pre-personalisation if necessary.

19 In addition, three important stages have to be considered in the Composite Product life cycle:

- Security IC Embedded Software Development (Phase 1),
- the Composite Product finishing process, preparation and shipping to the personalisation line for the Composite Product (Composite Product Integration Phase 5),
- the Composite Product personalisation and testing stage where the User Data is loaded into the Security IC's memory (Personalisation Phase 6),

- the Composite Product usage by its issuers and consumers (Operational Usage Phase 7) which may include loading and other management of applications in the field.

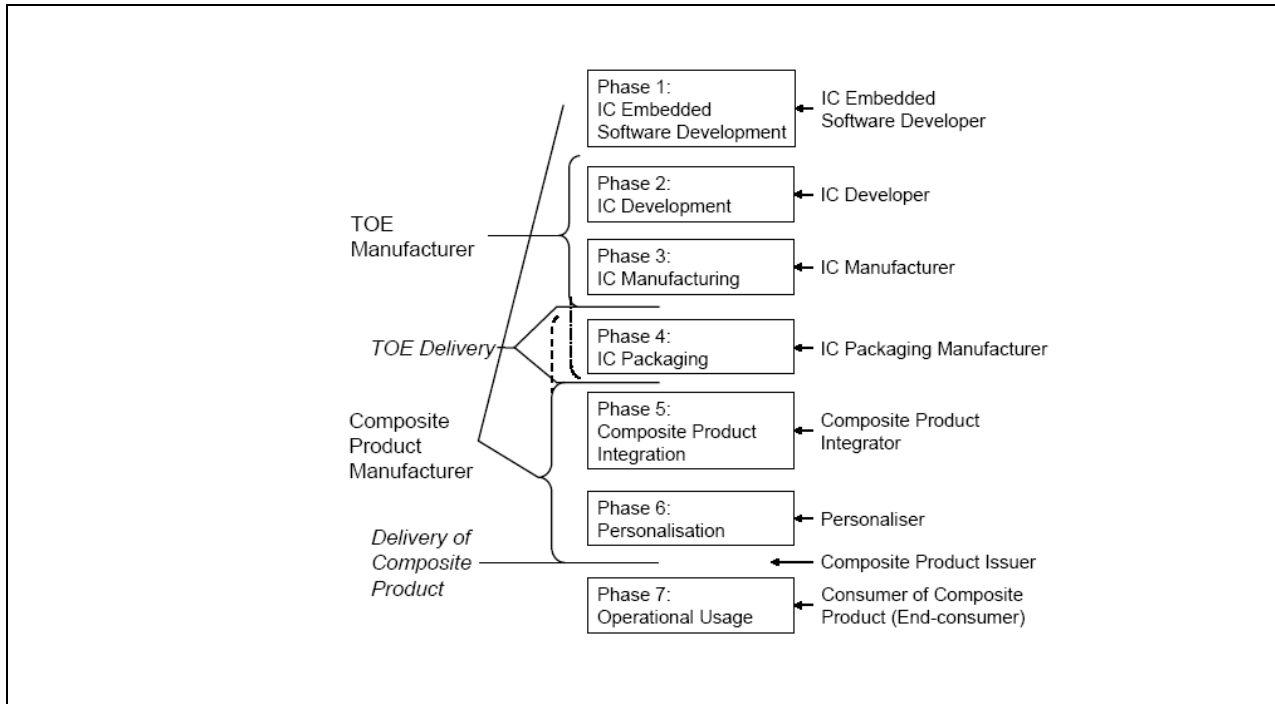

Figure 1: Definition of "TOE Delivery" and responsible Parties

- 20 The Security IC Embedded Software is developed outside the TOE development in Phase 1. The TOE is developed in Phase 2 and produced in Phase 3. Then the TOE is delivered in form of wafers.

1.3 Interfaces of the TOE

- The physical interface of the TOE with the external environment is the entire surface of the IC
- The electrical interface of the TOE with the external environment is made of the chip's pads including the Vdd, RESETB, XCLK, GND, IO1, IO2, L1 and L2 pads as well as the contactless radio-frequency interface
- The data interface of the TOE is made of the Contact I/O pads and Contactless I/O pads.
- The software interface of the TOE with the hardware consists of Special Function Registers (SFR) and CPU instructions.
- The DRNG interface of the TOE is defined by the DRNG library interface.
- The TRNG interface of the TOE is defined by the TRNG library interface.
- The RSA interface of the TOE is defined by the RSA/ECC library interface (optional).
- The interface to the ECC and SHA calculations is defined from the RSA/ECC library interface (optional)

1.4 TOE Intended Usage

- 21 The TOE is dedicated to applications such as:

- Banking and finance applications for credit or debit cards, electronic purse (stored value cards)

and electronic commerce.

- Network based transaction processing such a mobile phones (GSM SIM cards), pay TV (subscriber and pay-per-view cards), communication highways (Internet access and transaction processing).
- Transport and ticketing applications (access control cards).
- Governmental cards (ID cards, health cards, driving licenses).
- Multimedia applications and Digital Right Management protection.

2 CONFORMANCE CLAIMS

22 This chapter 2 contains the following sections:

2.1 CC Conformance Claim

2.2 PP Claim

2.3 Package Claim

2.4 Conformance Claim Rationale

2.1 CC Conformance Claim

23 This Security target claims to be conformant to the Common Criteria version 3.1.

24 Furthermore it claims to be CC Part 2 extended and CC Part 3 conformant. The extended Security Functional Requirements are defined in chapter 5.

25 This *Security Target* has been built with the Common Criteria for Information Technology Security Evaluation; Version 3.1 which comprises

[1] Common Criteria, Part 1: Common Criteria for Information Technology Security Evaluation, Part 1: Introduction and General Model, Version 3.1, Revision 3, July 2009, CCMB-2009-07-001

[2] Common Criteria, Part 2: Common Criteria for Information Technology Security Evaluation, Part 2: Security Functional Components, Version 3.1, Revision 3, July 2009, CCMB-2009-07-002

[3] Common Criteria, Part 3: Common Criteria for Information Technology Security Evaluation, Part 3: Security Assurance Components, Version 3.1, Revision 3, July 2009, CCMB-2009-07-003

[4] Common Methodology for Information Technology Security Evaluation, Evaluation Methodology, Version 3.1, Revision 3, July 2009, CCMB-2009-07-004

26 has been taken into account.

2.2 PP Claim

27 This Security Target is strict compliant to the Security IC Platform Protection Profile [5]. The Security IC Platform Protection Profile is registered and certified by the Bundesamt für Sicherheit in der Informationstechnik (BSI) under the reference BSI-PP-0035, Version 1.0, dated 15.06.2007.

28 This ST does not claim conformance to any other PP.

2.3 Package Claim

29 The assurance level for this Security Target is EAL5 augmented with AVA_VAN.5 and ALC_DVS.2.

2.4 Conformance Claim Rationale

30 This security target claims strict conformance only to one PP, the Security IC Platform Protection Profile [5].

31 The Evaluation Assurance Level (EAL) of the PP [5] is EAL 4 augmented with the assurance components ALC_DVS.2 and AVA_VAN.5. The Assurance Requirements of the TOE obtain the Evaluation Assurance Level 5 augmented with the assurance components ALC_DVS.2 and AVA_VAN.5 for the TOE.

-
- 32 The Target of Evaluation (TOE) is a complete solution implementing a security integrated circuit (security IC) as defined in the PP [5] section 1.3.1, so the TOE is consistent with the TOE type in the PP [5].
- 33 The security problem definition of this security target is consistent with the statement of the security problem definition in the PP [5], as the security target claimed strict conformance to the PP [5]. Additional threats, organisational security policies and assumptions are introduced in chapter 3 of this ST, a rationale is given in chapter 4.4.
- 34 The security objectives of this security target are consistent with the statement of the security objectives in the PP [5], as the security target claimed strict conformance to the PP [5]. Additional security objectives are added in chapter 4.1 of this ST, a rationale is given in chapter 4.4.
- 35 The security requirements of this security target are consistent with the statement of the security requirements in the PP [5], as the security target claimed strict conformance to the PP [5]. Additional security requirements are added in chapter 6.1 of this ST, a rationale is given in chapter 6.3. All assignments and selections of the security functional requirements are done in the PP [5] and in this security target section 6.1.

3 SECURITY PROBLEM DEFINITION

36 This chapter 3 contains the following sections:

- 3.1 Description of Assets
- 3.2 Threats
- 3.3 Organizational Security Policies
- 3.4 Assumptions

3.1 Description of Assets

Assets regarding the Threats

37 The assets (related to standard functionality) to be protected are

- the User Data,
- the Security IC Embedded Software,
- the security services provided by the TOE for the Security IC Embedded Software.

38 The user (consumer) of the TOE places value upon the assets related to high-level security concerns:

- SC1 integrity of User Data and of the Security IC Embedded Software (while being executed/processed and while being stored in the TOE's memories),
- SC2 confidentiality of User Data and of the Security IC Embedded Software (while being processed and while being stored in the TOE's memories)
- SC3 correct operation of the security services provided by the TOE for the Security IC Embedded Software.

39 The Security IC may not distinguish between User Data which are public known or kept confidential. Therefore the security IC shall protect the confidentiality and integrity of the User Data, unless the Security IC Embedded Software chooses to disclose or modify it.

40 In particular integrity of the Security IC Embedded Software means that it is correctly being executed which includes the correct operation of the TOE's functionality. Though the Security IC Embedded Software (normally stored in the ROM) will in many cases not contain secret data or algorithms, it must be protected from being disclosed, since for instance knowledge of specific implementation details may assist an attacker.

41 The Protection Profile requires the TOE to provide one security service: the generation of random numbers by means of an physical Random Number Generator. The Security Target may require additional security services. It is essential that the TOE ensures the correct operation of all security services provided by the TOE for the Security IC Embedded Software.

42 According to the Protection Profile there is the following high-level security concern related to security service:

- SC4 deficiency of random numbers.

43 To be able to protect these assets the TOE shall protect its security functionality. Therefore critical information about the TOE shall be protected. Critical information includes:

- logical design data, physical design data, IC Dedicated Software, and configuration data,

- Initialisation Data and Pre-personalisation Data, specific development aids, test and characterisation related data, material for software development support, and photomasks.

Such information and the ability to perform manipulations assist in threatening the above assets.

- 44 Note that there are many ways to manipulate or disclose the User Data: (i) An attacker may manipulate the Security IC Embedded Software or the TOE. (ii) An attacker may cause malfunctions of the TOE or abuse Test Features provided by the TOE. Such attacks usually require design information of the TOE to be obtained. They pertain to all information about (i) the circuitry of the IC (hardware including the physical memories), (ii) the IC Dedicated Software with the parts IC Dedicated Test Software (if any) and IC Dedicated Support Software (if any), and (iii) the configuration data for the security functionality. The knowledge of this information enables or supports attacks on the assets. Therefore the TOE Manufacturer must ensure that the development and production of the TOE is secure so that no information is unintentionally made available for the operational phase of the TOE.
- 45 The TOE Manufacturer must apply protection to support the security of the TOE. This not only pertains to the TOE but also to all information and material exchanged with the developer of the Security IC Embedded Software. This covers the Security IC Embedded Software itself if provided by the developer of the Security IC Embedded Software or any authentication data required to enable the download of software. This includes the delivery (exchange) procedures for Phase 1 and the Phases after TOE Delivery as far as they can be controlled by the TOE Manufacturer. These aspects enforce the usage of the supporting documents and the refinements of SAR defined in the protection profile.
- 46 The information and material produced and/or processed by the TOE Manufacturer in the TOE development and production environment (Phases 2 up to TOE Delivery) can be grouped as follows:
- logical design data,
 - physical design data,
 - IC Dedicated Software, Security IC Embedded Software, Initialisation Data and Pre-personalisation Data,
 - specific development aids,
 - test and characterisation related data,
 - material for software development support, and
 - photomasks and products in any form

as long as they are generated, stored, or processed by the TOE Manufacturer.

3.2 Threats

- 47 The following explanations help to understand the focus of the threats and objectives defined below. For example, certain attacks are only one step towards a disclosure of assets, others may directly lead to a compromise of the application security.
- Manipulation of data (which may comprise any data, including code, stored in or processed by the Security IC) means that an attacker is able to alter a meaningful block of data. This should be considered for the threats T.Malfunction, T.Phys-Manipulation and T.Abuse-Func.
 - Manipulation of the TOE means that an attacker is able to deliberately deactivate or otherwise change the behaviour of a specific function in a manner which enables exploitation. This should be considered for the threat T.Malfunction, T.Phys-Manipulation and T.Abuse-Func.

- Disclosure of data (which may comprise any data, including code, stored in or processed by the Security IC) means that an attacker is realistically able to determine a meaningful block of data. This should be considered for the threats T.Leak-Inherent, T.Phys-Probing, T.Leak-Forced and T.Abuse-Func.
- 48 The cloning of the functional behaviour of the Security IC on its physical and command interface is the highest level security concern in the application context.
- 49 The cloning of that functional behaviour requires to (i) develop a functional equivalent of the Security IC Embedded Software, (ii) disclose, interpret and employ the secret User Data stored in the TOE, and (iii) develop and build a functional equivalent of the Security IC using the input from the previous steps.
- 50 The Security IC is a platform for the Security IC Embedded Software which ensures that especially the critical User Data are stored and processed in a secure way (refer to below). The Security IC Embedded Software must also ensure that critical User Data are treated as required in the application context. In addition, the personalisation process supported by the Security IC Embedded Software (and perhaps by the Security IC in addition) must be secure. This last step is beyond the scope of the Protection Profile. As a result the threat “cloning of the functional behaviour of the Security IC on its physical and command interface” is averted by the combination of measures which split into those being evaluated according to the Protection Profile (Security IC) and those being subject to the evaluation of the Security IC Embedded Software or Security IC and the corresponding personalisation process. Therefore, functional cloning is indirectly covered by the security concerns and threats described below.
- 51 The high-level security concerns are refined below by defining threats as required by the Common Criteria (refer to Figure 3). Note that manipulation of the TOE is only a means to threaten User Data or the Security IC Embedded Software and is not a success for the attacker in itself.

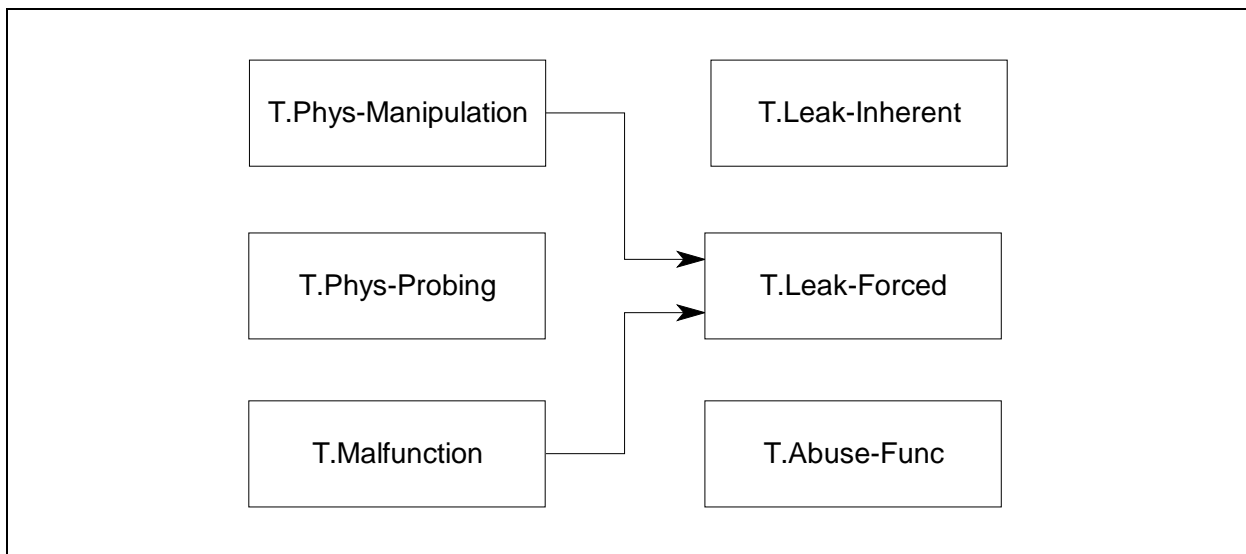

Figure 3: Standard Threats

- 52 The high-level security concern related to security service is refined below by defining threats as required by the Common Criteria (refer to Figure 4).

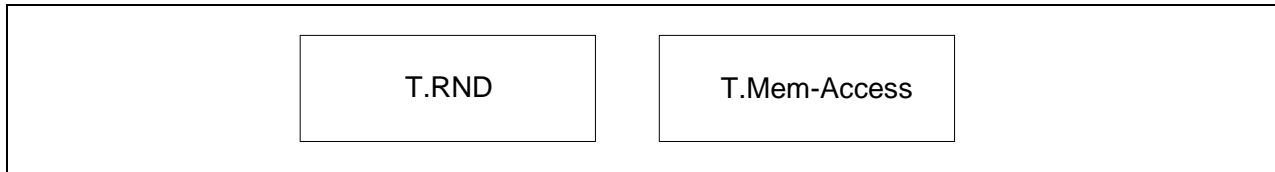

Figure 4: Threats related to security service

- 53 The Security IC Embedded Software must contribute to averting the threats: At least it must not undermine the security provided by the TOE.
- 54 The above security concerns are derived from considering the end-usage phase (Phase 7) since
 - Phase 1 and the Phases from TOE Delivery up to the end of Phase 6 are covered by assumptions and
 - the development and production environment starting with Phase 2 up to TOE Delivery are covered by an organisational security policy.
- 55 The TOE’s countermeasures are designed to avert the threats described below. Nevertheless, they may be effective in earlier phases (Phases 4 to 6).
- 56 The TOE is exposed to different types of influences or interactions with its outer world. Some of them may result from using the TOE only but others may also indicate an attack. The different types of influences or interactions are visualised in Figure 5. Due to the intended usage of the TOE all interactions are considered as possible.

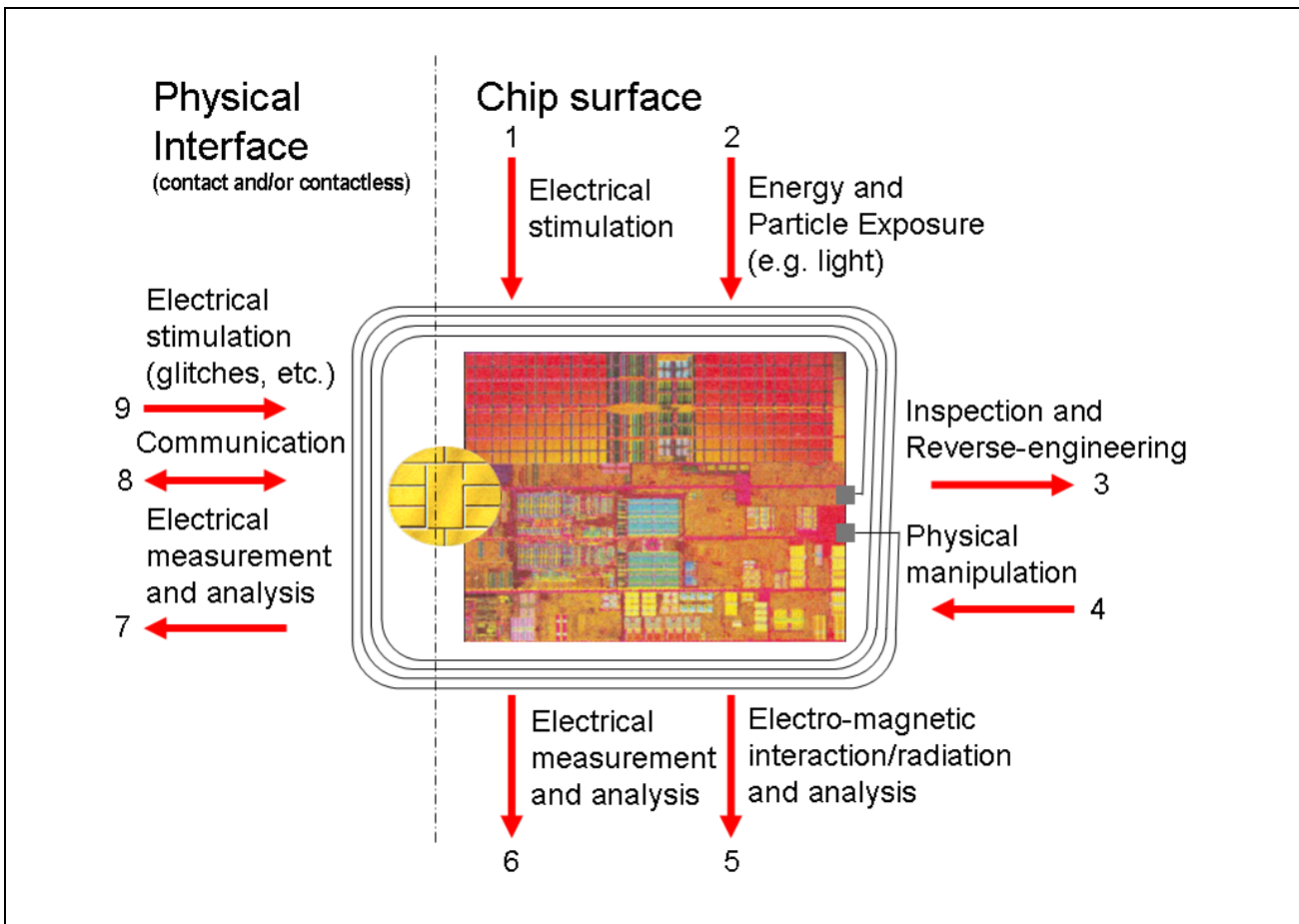

Figure 5: Interactions between the TOE and its outer world

- 57 An interaction with the TOE can be done through the physical interfaces (Number 7 – 9 in Figure 5) which are realised using contacts or a contactless interface. Influences or interactions with the TOE also occurs through the chip surface (Number 1 – 6 in Figure 5). In Number 1 and 6 galvanic contacts are used. In Number 2 and 5 the influence (arrow directed to the chip) or the measurement (arrow starts from the chip) does not require a contact. Number 3 and 4 refer to specific situations where the TOE and its functional behaviour is not only influenced but definite changes are made by applying mechanical, chemical and other methods (such as 1, 2). Many attacks require a prior inspection and some reverse-engineering (Number 3). This demonstrates the basic building blocks of attacks. A practical attack will use a combination of these elements.

3.2.1 Standard Threats

- 58 The TOE shall avert the threat “Inherent Information Leakage (T.Leak-Inherent)” as specified below.

T.Leak-Inherent Inherent Information Leakage

An attacker may exploit information which is leaked from the TOE during usage of the Security IC in order to disclose confidential data as part of the assets.

No direct contact with the Security IC internals is required here. Leakage may occur through emanations, variations in power consumption, I/O characteristics, clock frequency, or by changes in processing time requirements. One example is the Differential Power Analysis (DPA). This leakage may be interpreted as a covert channel transmission but is more closely related to measurement of operating parameters, which may be derived either from direct (contact) measurements (Numbers 6 and 7 in Figure 5) or measurement of emanations (Number 5 in Figure 5) and can then be related to the specific operation being performed.

- 59 The TOE shall avert the threat “Physical Probing (T.Phys-Probing)” as specified below.

T.Phys-Probing Physical Probing

An attacker may perform physical probing of the TOE in order (i) to disclose User Data, (ii) to disclose/reconstruct the Security IC Embedded Software or (iii) to disclose other critical information about the operation of the TOE.

Physical probing requires direct interaction with the Security IC internals (Numbers 5 and 6 in Figure 5). Techniques commonly employed in IC failure analysis and IC reverse engineering efforts may be used. Before that hardware security mechanisms and layout characteristics need to be identified (Number 3 in Figure 5). Determination of software design including treatment of User Data may also be a pre-requisite.

This pertains to “measurements” using galvanic contacts or any type of charge interaction whereas manipulations are considered under the threat “Physical Manipulation (T.Phys-Manipulation)”. The threats “Inherent Information Leakage (T.Leak-Inherent)” and “Forced Information Leakage (T.Leak-Forced)” may use physical probing but require complex signal processing in addition.

- 60 The TOE shall avert the threat “Malfunction due to Environmental Stress (T.Malfunction)” as specified below.

T.Malfunction Malfunction due to Environmental Stress

An attacker may cause a malfunction of TSF or of the Security IC Embedded Software by applying environmental stress in order to (i) deactivate or modify security features or security services of the TOE or (ii) deactivate or modify functions of the Security IC Embedded Software. This may be achieved by operating the Security IC outside the normal operating conditions (Numbers 1, 2 and 9 in Figure 5).

The modification of security services of the TOE may e.g. affect the quality of random numbers provided by the random number generator up to undetected deactivation when the random number generator does not produce random numbers and the Security IC Embedded Software gets constant values. In another case errors are introduced in executing the Security IC Embedded Software. To exploit this an attacker needs information about the functional operation, e.g. to introduce a temporary failure within a register used by the Security IC Embedded Software with light or a power glitch.

- 61 The TOE shall avert the threat “Physical Manipulation (T.Phys-Manipulation)” as specified below.

T.Phys-Manipulation Physical Manipulation

An attacker may physically modify the Security IC in order to (i) modify security features or security services of the TOE, (ii) modify functions of the Security IC Embedded Software or (iii) to modify User Data.

The modification may be achieved through techniques commonly employed in IC fail-ure analysis (Numbers 1, 2 and 4 in Figure 8) and IC reverse engineering efforts (Number 3 in Figure 8). The modification may result in the deactivation of a security feature. Before that hardware security mechanisms and layout characteristics need to be identified. Determination of software design including treatment of User Data may also be a pre-requisite. Changes of circuitry or data can be permanent or temporary.

In contrast to malfunctions (refer to T.Malfunction) the attacker requires to gather significant knowledge about the TOE’s internal construction here (Number 3 in Figure 5).

- 62 The TOE shall avert the threat “Forced Information Leakage (T.Leak-Forced)” as specified below:

T.Leak-Forced Forced Information Leakage

An attacker may exploit information which is leaked from the TOE during usage of the Security IC in order to disclose confidential data as part of the assets even if the information leakage is not inherent but caused by the attacker.

This threat pertains to attacks where methods described in “Malfunction due to Environmental Stress” (refer to T.Malfunction) and/or “Physical Manipulation” (refer to T.Phys-Manipulation) are used to cause leakage from signals (Numbers 5, 6, 7 and 8 in Figure 5) which normally do not contain significant information about secrets.

- 63 The TOE shall avert the threat “Abuse of Functionality (T.Abuse-Func)” as specified below.

T.Abuse-Func Abuse of Functionality

An attacker may use functions of the TOE which may not be used after TOE Delivery in order to (i) disclose or manipulate User Data, (ii) manipulate (explore, bypass, deactivate or change) security services of the TOE or (iii) manipulate (explore, bypass, deactivate or change) functions of the Security IC Embedded Software or (iv) enable an attack disclosing or manipulating the User Data or the Security IC Embedded Software.

3.2.2 Threats related to security services

- 64 The TOE shall avert the threat “Deficiency of Random Numbers (T.RND)” as specified below.

T.RND

Deficiency of Random Numbers

An attacker may predict or obtain information about random numbers generated by the TOE for instance because of a lack of entropy of the random numbers provided.

An attacker may gather information about the produced random numbers which might be a problem because they may be used for instance to generate cryptographic keys.

Here the attacker is expected to take advantage of statistical properties of the random numbers generated by the TOE without specific knowledge about the TOE's generator. Malfunctions or premature ageing are also considered which may assist in getting information about random numbers.

3.2.3 Threats related to additional TOE Specific Functionality

65 The TOE shall avert the additional threat "Memory Access Violation (T.Mem-Access)" as specified below.

T.Mem-Access

Memory Access Violation

Parts of the Smartcard Embedded Software may cause security violations by accidentally or deliberately accessing restricted data (which may include code). Any restrictions are defined by the security policy of the specific application context and must be implemented by the Smartcard Embedded Software.

3.3 Organizational Security Policies

66 The following Figure 6 shows the policies applied in this Security Target.

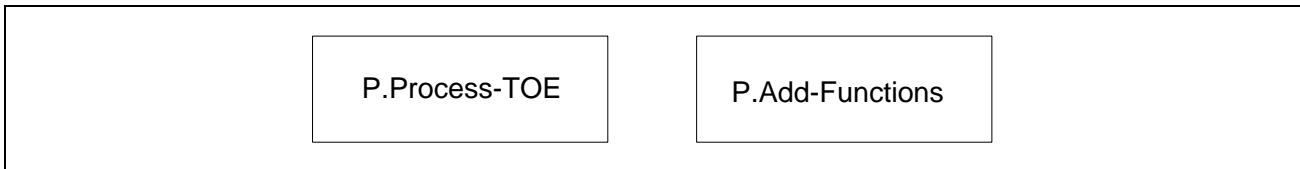

Figure 6: Policies

67 The IC Developer / Manufacturer must apply the policy "Protection during TOE Development and Production (P.Process-TOE)" as specified below.

P.Process-TOE

Protection during TOE Development and Production

An accurate identification must be established for the TOE. This requires that each instantiation of the TOE carries this unique identification.

68 The accurate identification is introduced at the end of the production test in phase 3. Therefore the production environment must support this unique identification.

69 The information and material produced and/or processed by the TOE Manufacturer in the TOE development and production environment (Phases 2 up to TOE Delivery) can be grouped as follows:

- logical design data,
- physical design data,

- IC Dedicated Software, Security IC Embedded Software, Initialisation Data and Pre-personalisation Data,
- specific development aids,
- test and characterisation related data,
- material for software development support, and
- photomasks and products in any form

as long as they are generated, stored, or processed by the TOE Manufacturer.

70 The TOE provides specific security functionality which can be used by the Smartcard Embedded Software. In the following specific security functionality is listed which is not derived from threats identified for the TOE's environment because it can only be decided in the context of the smartcard application, against which threats the Smartcard Embedded Software will use the specific security functionality.

71 The IC Developer / Manufacturer must apply the policy "Additional Specific Security Functionality (P.Add-Functions)" as specified below.

P.Add-Functions

Additional Specific Security Functionality

The TOE shall provide the following specific security functionality to the Smartcard Embedded Software:

- Triple Data Encryption Standard (3DES)
- Advanced Encryption Standard (AES)
- Rivest-Shamir-Adleman (RSA) public key asymmetric cryptography (optional)
- Elliptic Curve Cryptography (ECC) and Secure Hash Algorithm (SHA) (optional)

Note: The TOE can be delivered without the RSA/ECC crypto library. In this case the TOE does not provide the Additional Specific Security Functionality Rivest-Shamir-Adleman Cryptography and Elliptic Curve Cryptography (ECC) and Secure Hash Algorithm (SHA).

3.4 Assumptions

72 The intended usage of the TOE is twofold, depending on the Life Cycle Phase: (i) The Security IC Embedded Software developer uses it as a platform for the Security IC software being developed. The Composite Product Manufacturer (and the consumer) uses it as a part of the Security IC. The Composite Product is used in a terminal which supplies the Security IC (with power and clock) and (at least) mediates the communication with the Security IC Embedded Software.

73 Before being delivered to the consumer the TOE is packaged. Many attacks require the TOE to be removed from the carrier. Though this extra step adds difficulties for the attacker no specific assumptions are made here regarding the package.

74 Appropriate "Protection during Packaging, Finishing and Personalisation (A.Process-Sec-IC)" must be ensured after TOE Delivery up to the end of Phase 6, as well as during the delivery to Phase 7 as specified below.

A.Process-Sec-IC Protection during Packaging, Finishing and Personalisation

It is assumed that security procedures are used after delivery of the TOE by the TOE Manufacturer up to delivery to the consumer to maintain confidentiality and integrity of the TOE and of its manufacturing and test data (to prevent any possible copy, modification, retention, theft or unauthorised use).

This means that the Phases after TOE Delivery are assumed to be protected appropriately.

75 The information and material produced and/or processed by the Security IC Embedded Software Developer in Phase 1 and by the Composite Product Manufacturer can be grouped as follows:

- the Security IC Embedded Software including specifications, implementation and related documentation,
- pre-personalisation and personalisation data including specifications of formats and memory areas, test related data,
- the User Data and related documentation, and
- material for software development support

as long as they are not under the control of the TOE Manufacturer. Details must be defined in the Protection Profile or Security Target for the evaluation of the Security IC Embedded Software and/or Security IC.

76 The developer of the Security IC Embedded Software must ensure the appropriate "Usage of Hardware Platform (A.Plat-Appl)" while developing this software in Phase 1 as specified below.

A.Plat-Appl Usage of Hardware Platform

The Security IC Embedded Software is designed so that the requirements from the following documents are met: (i) TOE guidance documents (refer to the Common Criteria assurance class AGD) such as the hardware data sheet, and the hardware application notes, and (ii) findings of the TOE evaluation reports relevant for the Security IC Embedded Software as documented in the certification report.

77 Note that particular requirements for the Security IC Embedded Software are often not clear before considering a specific attack scenario during vulnerability analysis of the Security IC (AVA_VAN). A summary of such results is provided in the document "ETR for composite evaluation" (ETR-COMP). This document can be provided for the evaluation of the composite product. The ETR-COMP may also include guidance for additional tests being required for the combination of hardware and software. The TOE evaluation must be completed before evaluation of the Security IC Embedded Software can be completed. The TOE evaluation can be conducted before and independent from the evaluation of the Security IC Embedded Software.

78 The developer of the Security IC Embedded Software must ensure the appropriate "Treatment of User Data (A.Resp-Appl)" while developing this software in Phase 1 as specified below.

79

A.Resp-Appl Treatment of User Data

All User Data are owned by Security IC Embedded Software. Therefore, it must be assumed that security relevant User Data (especially cryptographic

keys) are treated by the Security IC Embedded Software as defined for its specific application context.

The application context specifies how the User Data shall be handled and protected. The evaluation of the Security IC according to this Protection Profile is conducted on generalized application context. The concrete requirements for the Security IC Embedded Software shall be defined in the Protection Profile respective Security Target for the Security IC Embedded Software. The Security IC can not prevent any compromise or modification of User Data by malicious Security IC Embedded Software. The assumption A.Resp-Appl ensures that the Security IC Embedded Software follows the security rules of the application context. Examples are given in Section 7.2.1, all being directly related to and covered by A.Resp-Appl.

- 80 The developer of the Smartcard Embedded Software must ensure the appropriate “Usage of Key-dependent Functions (A.Key-Function)” while developing this software in Phase 1 as specified below.

A.Key-Function Usage of Key-dependent Functions

Key-dependent functions (if any) shall be implemented in the Smartcard Embedded Software in a way that they are not susceptible to leakage attacks (as described under T.Leak-Inherent and T.Leak-Forced).

Note that here the routines which may compromise keys when being executed are part of the Smartcard Embedded Software. In contrast to this the threats T.Leak-Inherent and T.Leak-Forced address (i) the cryptographic routines which are part of the TOE and (ii) the processing of User Data including cryptographic keys.

4 SECURITY OBJECTIVES

81 This chapter Security Objectives contains the following sections:

- 4.1 Security Objectives for the TOE
- 4.2 Security Objectives for the IC Embedded Software development Environment
- 4.3 Security Objectives for the operational Environment
- 4.4 Security Objectives Rationale

4.1 Security objectives for the TOE

82 According to the Protection Profile[BSI-PP-0035] there are the following standard high-level security goals:

- SG1 maintain the integrity of User Data and of the Security IC Embedded Software (when being executed/processed and when being stored in the TOE's memories) as well as
- SG2 maintain the confidentiality of User Data and of the Security IC Embedded Software (when being processed and when being stored in the TOE's memories).

The Security IC may not distinguish between User Data which are public known or kept confidential. Therefore the security IC shall protect the confidentiality and integrity of the User Data, unless the Security IC Embedded Software chooses to disclose or modify it.

In particular integrity of the Security IC Embedded Software means that it is correctly being executed which includes the correct operation of the TOE's functionality. Though the Security IC Embedded Software (normally stored in the ROM) will in many cases not contain secret data or algorithms, it must be protected from being disclosed, since for instance knowledge of specific implementation details may assist an attacker.

- SG3 maintain the correct operation of the security services provided by the TOE for the Security IC Embedded Software.
- SG4 provide random numbers.

83 These standard high-level security goals are refined below by defining security objectives as required by the *Common Criteria*. Note that the integrity of the TOE is a mean to reach these objectives.

Standard Security Objectives

84 The TOE shall provide "Protection against Inherent Information Leakage (O.Leak-Inherent)" as specified below.

O.Leak-Inherent Protection against Inherent Information Leakage

The TOE must provide protection against disclosure of confidential data (User Data or TSF data) stored and/or processed in the Smartcard IC

- by measurement and analysis of the shape and amplitude of signals (for example on the power, clock, or I/O lines) and
- by measurement and analysis of the time between events found by measuring signals (for instance on the power, clock, or I/O lines).

This objective pertains to measurements with subsequent complex signal processing whereas O.Phys-Probing is about direct measurements on

elements on the chip surface. Details correspond to an analysis of attack scenarios which is not given here.

85 The TOE shall provide “Protection against Physical Probing (O.Phys-Probing)” as specified below.

O.Phys-Probing

Protection against Physical Probing

The TOE must provide protection against disclosure of User Data, against the disclosure/reconstruction of the Smartcard Embedded Software or against the disclosure of other critical operational information. This includes protection against

- measuring through galvanic contacts which is direct physical probing on the chips surface except on pads being bonded (using standard tools for measuring voltage and current) or
- measuring not using galvanic contacts but other types of physical interaction between charges (using tools used in solid-state physics research and IC failure analysis)

with a prior

- reverse-engineering to understand the design and its properties and functions.

The TOE must be designed and fabricated so that it requires a high combination of complex equipment, knowledge, skill, and time to be able to derive detailed design information or other information which could be used to compromise security through such a physical attack.

86 The TOE shall provide “Protection against Malfunctions (O.Malfunction)” as specified below.

O.Malfunction

Protection against Malfunctions

The TOE must ensure its correct operation.

The TOE must prevent its operation outside the normal operating conditions where reliability and secure operation has not been proven or tested. This is to prevent errors. The environmental conditions may include voltage, clock frequency, temperature, or external energy fields.

Remark: A malfunction of the TOE may also be caused using a direct interaction with elements on the chip surface. This is considered as being a manipulation (refer to the objective O.Phys-Manipulation) provided that detailed knowledge about the TOE’s internal construction is required and the attack is performed in a controlled manner.

87 The TOE shall provide “Protection against Physical Manipulation (O.Phys-Manipulation)” as specified below.

O.Phys-Manipulation

Protection against Physical Manipulation

The TOE must provide protection against manipulation of the TOE (including its software and TSF data), the Smartcard Embedded Software and the User Data. This includes protection against

- reverse-engineering (understanding the design and its properties and functions),

- manipulation of the hardware and any data, as well as
- controlled manipulation of memory contents (User Data).

The TOE must be designed and fabricated so that it requires a high combination of complex equipment, knowledge, skill, and time to be able to derive detailed design information or other information which could be used to compromise security through such a physical attack.

- 88 The TOE shall provide “Protection against Forced Information Leakage (O.Leak-Forced)” as specified below:

O.Leak-Forced

Protection against Forced Information Leakage

The Security IC must be protected against disclosure of confidential data processed in the Security IC (using methods as described under O.Leak-Inherent) even if the information leakage is not inherent but caused by the attacker

- by forcing a malfunction (refer to “Protection against Malfunction due to Environmental Stress (O.Malfunction)” and/or
- by a physical manipulation (refer to “Protection against Physical Manipulation (O.Phys-Manipulation)”.

If this is not the case, signals which normally do not contain significant information about secrets could become an information channel for a leakage attack.

- 89 The TOE shall provide “Protection against Abuse of Functionality (O.Abuse-Func)” as specified below.

O.Abuse-Func

Protection against Abuse of Functionality

The TOE must prevent that functions of the TOE which may not be used after TOE Delivery can be abused in order (i) to disclose critical User Data, (ii) to manipulate critical User Data of the Smartcard Embedded Software, (iii) to manipulate Soft-coded Smartcard Embedded Software or (iv) bypass, deactivate, change or explore security features or functions of the TOE. Details depend, for instance, on the capabilities of the Test Features provided by the IC Dedicated Test Software which are not specified here.

- 90 The TOE shall provide “TOE Identification (O.Identification)” as specified below:

O.Identification

TOE Identification

The TOE must provide means to store Initialisation Data and Pre-personalisation Data in its non-volatile memory. The Initialisation Data (or parts of them) are used for TOE identification.

Security Objectives related to Specific Functionality (referring to SC4)

- 91 The TOE shall provide “Random Numbers (O.RND)” as specified below.

O.RND

Random Numbers

The TOE will ensure the cryptographic quality of random number generation. For instance random numbers shall not be predictable and shall have sufficient entropy.

The TOE will ensure that no information about the produced random numbers is available to an attacker since they might be used for instance to generate cryptographic keys.

Security Objectives for Added Function

- 92 The TOE shall provide “Additional Specific Security Functionality (O.Add-Functions)” as specified below.

O.Add-Functions Additional Specific Security Functionality

The TOE must provide the following specific security functionality to the Smartcard Embedded Software:

- Triple Data Encryption Standard (3DES)
- Advanced Encryption Standard (AES)
- Rivest-Shamir-Adleman (RSA) public key asymmetric cryptography (optional)
- Elliptic Curve Cryptography (ECC) and Secure Hash Algorithm (SHA).(optional)

Note: The TOE can be delivered without the RSA/ECC crypto library. In this case the TOE does not provide the Additional Specific Security Functionality Rivest-Shamir-Adleman Cryptography and Elliptic Curve Cryptography (ECC) and Secure Hash Algorithm (SHA).

- 93 The TOE shall provide “Area based Memory Access Control (O.Mem-Access)” as specified below.

O.Mem-Access Area based Memory Access Control

The TOE must provide the Smartcard Embedded Software with the capability to define restricted access memory areas. The TOE must then enforce the partitioning of such memory areas so that access of software to memory areas is controlled as required, for example, in a multi-application environment.

4.2 Security Objectives for the Security IC Embedded software development Environment

Phase 1

- 94 The Security IC Embedded Software shall provide “Usage of Hardware Platform (OE.Plat-Appl)” as specified below.

OE.Plat-Appl Usage of Hardware Platform

To ensure that the TOE is used in a secure manner the Security IC Embedded Software shall be designed so that the requirements from the following documents are met: (i) hardware data sheet for the TOE, (ii) data sheet of the IC Dedicated Software of the TOE, (iii) TOE application notes, other guidance documents, and (iv) findings of the TOE evaluation reports relevant for the Security IC Embedded Software as referenced in the certification report.

- 95 The Security IC Embedded Software shall provide “Treatment of User Data (OE.Resp-Appl)” as specified below.

OE.Resp-Appl

Treatment of User Data

Security relevant User Data (especially cryptographic keys) are treated by the Smartcard Embedded Software as required by the security needs of the specific application context.

For example the Smartcard Embedded Software will not disclose security relevant user data to unauthorised users or processes when communicating with a terminal.

4.2.1 Clarification of “Usage of Hardware Platform (OE.Plat-Appl)”

- 96 Regarding the cryptographic services this objective of the environment has to be clarified. The TOE supports cipher schemes as additional specific security functionality. If required the Smartcard Embedded Software shall use these cryptographic services of the TOE and their interface as specified. When key-dependent functions implemented in the Smartcard Embedded Software are just being executed, the Smartcard Embedded Software must provide protection against disclosure of confidential data (User Data) stored and/or processed in the TOE by using the methods described under “Inherent Information Leakage (T.Leak-Inherent)” and “Forced Information Leakage (T.Leak-Forced)”.
- 97 Regarding the area based access control this objective of the environment has to be clarified. For the separation of different applications the Smartcard Embedded Software (Operating System) may implement a memory management scheme based upon security mechanisms of the TOE.
- 98 For the separation of different applications the Smartcard Embedded Software may implement a memory management scheme based upon security mechanisms of the TOE as required by the security policy defined for the specific application context.

4.2.2 Clarification of “Treatment of User Data (OE.Resp-Appl)”

- 99 Regarding the cryptographic services this objective of the environment has to be clarified. By definition cipher or plain text data and cryptographic keys are User Data. The Smartcard Embedded Software shall treat these data appropriately, use only proper secret keys (chosen from a large key space) as input for the cryptographic function of the TOE and use keys and functions appropriately in order to ensure the strength of cryptographic operation.
- 100 This means that keys are treated as confidential as soon as they are generated. The keys must be unique with a very high probability, as well as cryptographically strong. For example, it must be ensured that it is beyond practicality to derive the private key from a public key if asymmetric algorithms are used. If keys are imported into the TOE and/or derived from other keys, quality and confidentiality must be maintained. This implies that appropriate key management has to be realised in the environment.
- 101 Regarding the area based access control this objective of the environment has to be clarified. The treatment of User Data is also required when a multi-application operating system is implemented as part of the Smartcard Embedded Software on the TOE. In this case the multi-application operating system should not disclose security relevant user data of one application to another application when it is processed or stored on the TOE.
- 102 The treatment of User Data is still required when a multi-application operating system is implemented as part of the Smartcard Embedded Software on the TOE. In this case the multi-application operating system should not disclose security relevant user data of one application to another application when it is processed or stored on the TOE.

4.3 Security objectives for the operational Environment

TOE Delivery up to the end of Phase 6

- 103 Appropriate “Protection during Packaging, Finishing and Personalisation (OE.Process-Sec-IC)” must be ensured after TOE Delivery up to the end of Phases 6, as well as during the delivery to Phase 7 as specified below.

OE.Process-Sec-IC Protection during composite product manufacturing

Security procedures shall be used after TOE Delivery up to delivery to the "consumer" to maintain confidentiality and integrity of the TOE and of its manufacturing and test data (to prevent any possible copy, modification, retention, theft or unauthorised use).

This means that Phases after TOE Delivery up to the end of Phase 6 must be protected appropriately.

4.3.1 Clarification of “Protection during Composite product manufacturing (OE.Process-Sec-IC)”

- 104 The protection during packaging, finishing and personalization includes also the personalization process and the personalization data during Phase 4, Phase 5 and Phase 6.
- 105 Since OE.Process-Sec-IC requires the Composite Product Manufacturer to implement those measures assumed in A.Process-Sec-IC, the assumption is covered by this objective.

4.4 Security Objectives Rationale

- 106 Table 2 below gives an overview, how the assumptions, threats, and organisational security policies are addressed by the objectives. The text following after the table justifies this in detail.

Assumption, Threat or Organisational Security Policy	Security Objective	Notes
A.Plat-Appl	OE.Plat-Appl	Phase 1
A.Resp-Appl	OE.Resp-Appl	Phase 1
P.Process-TOE	O.Identification	Phase 2 – 3 optional Phase 4
A.Process-Sec-IC	OE.Process-Sec-IC	Phase 5 – 6 optional Phase 4
T.Leak-Inherent	O.Leak-Inherent	
T.Phys-Probing	O.Phys-Probing	
T.Malfunction	O.Malfunction	
T.Phys-Manipulation	O.Phys-Manipulation	
T.Leak-Forced	O.Leak-Forced	
T.Abuse-Func	O.Abuse-Func	
T.RND	O.RND	
T.Mem-Access	O.Mem-Access	
P.Add-Functions	O.Add-Functions	
A.Key-Function	OE.Plat-Appl OE.Resp-Appl	

Table 2: Security Objectives versus Assumptions, Threats or Policies

- 107 The justification related to the assumption “Usage of Hardware Platform (A.Plat-Appl)” is as follows:
- 108 Since OE.Plat-Appl requires the Smartcard Embedded Software developer to implement those measures assumed in A.Plat-Appl, the assumption is covered by the objective.
- 109 The justification related to the assumption “Treatment of User Data (A.Resp-Appl)” is as follows:
- 110 Since OE.Resp-Appl requires the developer of the Smartcard Embedded Software to implement measures as assumed in A.Resp-Appl, the assumption is covered by the objective.
- 111 The justification related to the organisational security policy “Protection during TOE Development and Production (P.Process-TOE)” is as follows:
- 112 O.Identification requires that the TOE has to support the possibility of a unique identification. The unique identification can be stored on the TOE. Since the unique identification is generated by the production environment the production environment must support the integrity of the generated unique identification. The technical and organisational security measures that ensure the security of the development environment and production environment are evaluated based on the assurance measures that are part of the evaluation. For a list of material produced and processed by the TOE Manufacturer refer to paragraph 43 (page 15). All listed items and the associated development and production environments are subject of the evaluation. Therefore, the organisational security policy P.Process-TOE is covered by this objective, as far as organisational measures are concerned.
- 113 The justification related to the assumption “Protection during Packaging, Finishing and Personalisation (A.Process-Sec-IC)” is as follows:
- 114 Since OE.Process-Sec-IC requires the Composite Product Manufacturer to implement those measures assumed in A.Process-Sec-IC, the assumption is covered by this objective.

- 115 The justification related to the threats “Inherent Information Leakage (T.Leak-Inherent)”, “Physical Probing (T.Phys-Probing)”, “Malfunction due to Environmental Stress (T.Malfunction)”, “Physical Manipulation (T.Phys-Manipulation)”, “Forced Information Leakage (T.Leak-Forced)”, “Abuse of Functionality (T.Abuse-Func)” and “Deficiency of Random Numbers (T.RND)” is as follows:
- 116 For all threats the corresponding objectives are stated in a way, which directly corresponds to the description of the threat. It is clear from the description of each objective, that the corresponding threat is removed if the objective is valid. More specifically, in every case the ability to use the attack method successfully is countered, if the objective holds.
- 117 The justification related to the threat “Memory Access Violation (T.Mem-Access)” is as follows:
- 118 According to O.Mem-Access the TOE must enforce the partitioning of memory areas so that access of software to memory areas is controlled. Any restrictions are to be defined by the Smartcard Embedded Software. Thereby security violations caused by accidental or deliberate access to restricted data (which may include code) can be prevented (refer to T.Mem-Access). The threat T.Mem-Access is therefore removed if the objective is met.
- 119 The clarification of “Usage of Hardware Platform (OE.Plat-Appl)” makes clear that it is up to the Smartcard Embedded Software to implement the memory management scheme by appropriately administrating the TSF. This is also expressed both in T.Mem-Access and O.Mem-Access. The TOE shall provide access control functions as a means to be used by the Smartcard Embedded Software. This is further emphasised by the clarification of “Treatment of User Data (OE.Resp-Appl)” which reminds that the Smartcard Embedded Software must not undermine the restrictions it defines. Therefore, the clarifications contribute to the coverage of the threat T.Mem-Access.
- 120 The justification related to the security objective “Additional Specific Security Functionality (O.Add-Functions)” is as follows:
- 121 Since O.Add-Functions requires the TOE to implement exactly the same specific security functionality as required by P.Add-Functions, the organisational security policy is covered by the objective.
- 122 Nevertheless the security objectives O.Leak-Inherent, O.Phys-Probing, O.Malfunction, O.Phys-Manipulation and O.Leak-Forced define how to implement the specific security functionality required by P.Add-Functions. (Note that these objectives support that the specific security functionality is provided in a secure way as expected from P.Add-Functions.) Especially O.Leak-Inherent and O.Leak-Forced refer to the protection of confidential data (User Data or TSF data) in general. User Data are also processed by the specific security functionality required by P.Add-Functions.
- 123 Compared to Smartcard IC Platform Protection Profile a clarification has been made for the security objective “Usage of Hardware Platform (OE.Plat-Appl)”: If required the Smartcard Embedded Software shall use these cryptographic services of the TOE and their interface as specified. In addition, the Smartcard Embedded Software must implement functions which perform operations on keys (if any) in such a manner that they do not disclose information about confidential data. The non disclosure due to leakage A.Key-Function attacks is included in this objective OE.Plat-Appl. This addition ensures that the assumption A.Plat-Appl is still covered by the objective OE.Plat-Appl although additional functions are being supported according to O.Add-Functions.
- 124 Compared to Smartcard IC Platform Protection Profile a clarification has been made for the security objective “Treatment of User Data (OE.Resp-Appl)”: By definition cipher or plain text data and cryptographic keys are User Data. So, the Smartcard Embedded Software will protect such data if required and use keys and functions appropriately in order to ensure the strength of cryptographic operation. Quality and confidentiality must be maintained for keys that are imported and/or derived from other keys. This implies that appropriate key management has to be realised in the environment. That is expressed by the assumption A.Key – Function which is covered from OE.Resp-Appl. These measures make sure that the assumption A.Resp-Appl is still covered by the security objective OE.Resp-Appl although additional functions are being supported according to P.Add-Functions.
- 125 The justification of the additional policy and the additional assumption show that they do not contradict to the rationale already given in the Protection Profile for the assumptions, policy and threats defined there.

5 EXTENDED COMPONENTS DEFINITION

126 This chapter 5 Extended Components Definition contains the following sections:

5.1 Definition of the family FCS_RNG

5.2 Definition of the Family FMT_LIM

5.3 Definition of the Family FAU_SAS

5.1 Definition of the Family FCS_RNG

127 To define the IT security functional requirements of the TOE an additional family (FCS_RNG) of the Class FCS (cryptographic support) is defined here. This family describes the functional requirements for random number generation used for cryptographic purposes.

FCS_RNG Generation of random numbers

Family behaviour

This family defines quality requirements for the generation of random numbers which are intended to be use for cryptographic purposes.

Component levelling:

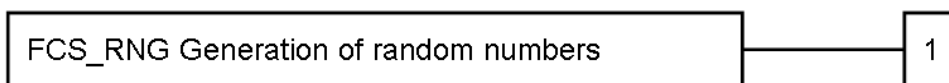

FCS_RNG.1	Generation of random numbers requires that random numbers meet a defined quality metric.
Management:	FCS_RNG.1 There are no management activities foreseen.
Audit:	FCS_RNG.1 There are no actions defined to be auditable.
FCS_RNG.1	Random number generation
Hierarchical to:	No other components.
Dependencies:	No dependencies.
FCS_RNG.1.1	The TSF shall provide a [selection: physical, non-physical true, deterministic, hybrid] random number generator that implements: [assignment: list of security capabilities].
FCS_RNG.1.2	The TSF shall provide random numbers that meet [assignment: a defined quality metric].

5.2 Definition of the Family FMT_LIM

- 128 To define the IT security functional requirements of the TOE an additional family (FMT_LIM) of the Class FMT (Security Management) is defined here. This family describes the functional requirements for the Test Features of the TOE. The new functional requirements were defined in the class FMT because this class addresses the management of functions of the TSF. The examples of the technical mechanism used in the TOE appropriate to address the specific issues of preventing the abuse of functions by limiting the capabilities of the functions and by limiting their availability.
- 129 The family “Limited capabilities and availability (FMT_LIM)” is specified as follows.

FMT_LIM Limited capabilities and availability

Family behaviour

This family defines requirements that limit the capabilities and availability of functions in a combined manner. Note that FDP_ACF restricts the access to functions whereas the component Limited Capability of this family requires the functions themselves to be designed in a specific manner.

Component levelling:



- FMT_LIM.1 Limited capabilities requires that the TSF is built to provide only the capabilities (perform action, gather information) necessary for its genuine purpose.
- FMT_LIM.2 Limited availability requires that the TSF restrict the use of functions (refer to Limited capabilities (FMT_LIM.1)). This can be achieved, for instance, by removing or by disabling functions in a specific phase of the TOE’s life-cycle.
- Management: FMT_LIM.1, FMT_LIM.2
There are no management activities foreseen.
- Audit: FMT_LIM.1, FMT_LIM.2
There are no actions defined to be auditable.

- 130 The TOE Functional Requirement “Limited capabilities (FMT_LIM.1)” is specified as follows.

- FMT_LIM.1** Limited capabilities
- Hierarchical to: No other components.
- FMT_LIM.1.1 The TSF shall be designed and implemented in a manner that limits their capabilities so that in conjunction with “Limited availability (FMT_LIM.2)” the following policy is enforced [assignment: Limited capability and availability policy].

Dependencies: FMT_LIM.2 Limited availability.

131 The TOE Functional Requirement “Limited availability (FMT_LIM.2)” is specified as follows.

FMT_LIM.2 Limited availability

Hierarchical to: No other components.

FMT_LIM.2.1 The TSF shall be designed in a manner that limits their availability so that in conjunction with “Limited capabilities (FMT_LIM.1)” the following policy is enforced [assignment: Limited capability and availability policy].

Dependencies: FMT_LIM.1 Limited capabilities.

132 Application note: The functional requirements FMT_LIM.1 and FMT_LIM.2 assume that there are two types of mechanisms (limited capabilities and limited availability) which together shall provide protection in order to enforce the policy. This also allows that

(i) the TSF is provided without restrictions in the product in its user environment but its capabilities are so limited that the policy is enforced

or conversely

(ii) the TSF is designed with high functionality but is removed or disabled in the product in its user environment.

The combination of both requirements shall enforce the policy.

5.3 Definition of the Family FAU_SAS

133 To define the security functional requirements of the TOE an additional family (FAU_SAS) of the Class FAU (Security Audit) is defined here. This family describes the functional requirements for the storage of audit data. It has a more general approach than FAU_GEN, because it does not necessarily require the data to be generated by the TOE itself and because it does not give specific details of the content of the audit records.

134 The family “Audit data storage (FAU_SAS)” is specified as follows.

FAU_SAS Audit data storage

Family behaviour

This family defines functional requirements for the storage of audit data.

Component levelling

FAU_SAS Audit data storage

1

FAU_SAS.1 Requires the TOE to provide the possibility to store audit data.

Management: FAU SAS.1

	There are no management activities foreseen.
Audit:	FAU_SAS.1
	There are no actions defined to be auditable.
FAU_SAS.1	Audit storage
Hierarchical to:	No other components.
FAU_SAS.1.1	The TSF shall provide [assignment: list of subjects] with the capability to store [assignment: list of audit information] in the [assignment: type of persistent memory].
Dependencies:	No dependencies.

6 IT SECURITY REQUIREMENTS

135 This chapter 6 IT Security Requirements contains the following sections:

- 6.1 Security Functional Requirements for the TOE
- 6.2 Security Assurance Requirements for the TOE
- 6.3 Security Requirements Rationale

6.1 Security Functional Requirements for the TOE

136 In order to define the Security Functional Requirements the Part 2 of the Common Criteria was used. However, some Security Functional Requirements have been refined. The refinements are described below the associated SFR. The operations completed in the ST are marked in italic font.

Malfunctions

137 The TOE shall meet the requirement "Limited fault tolerance (FRU_FLT.2)" as specified below.

FRU_FLT.2 Limited fault tolerance

Hierarchical to: FRU_FLT.1

FRU_FLT.2.1 The TSF shall ensure the operation of all the TOE's capabilities when the following failures occur: exposure to operating conditions which are not detected according to the requirement Failure with preservation of secure state (FPT_FLS.1) .

Dependencies: FPT_FLS.1 Failure with preservation of secure state

Refinement: The term "failure" above means "circumstances". The TOE prevents failures for the "circumstances" defined above.

138 The TOE shall meet the requirement "Failure with preservation of secure state (FPT_FLS.1)" as specified below.

FPT_FLS.1 Failure with preservation of secure state

Hierarchical to: No other components.

FPT_FLS.1.1 The TSF shall preserve a secure state when the following types of failures occur: exposure to operating conditions which may not be tolerated according to the requirement Limited fault tolerance (FRU_FLT.2) and where therefore a malfunction could occur.

Dependencies: No dependencies

Refinement: The term "failure" above also covers "circumstances". The TOE prevents failures for the "circumstances" defined above.

Application note: The secure state is maintained by TOE's detectors. The TOE's detectors are monitoring the failure occurs. The failures are abnormal frequency, abnormal voltage, abnormal temperature, and power glitch detectors that detect out of the specified range. If the failures are happen, the TOE goes into RESET state. This satisfies the FPT_FLS.1 "Failure with preservation of secure state."

Abuse of Functionality

139 The TOE shall meet the requirement “Limited capabilities (FMT_LIM.1)” as specified below (Common Criteria Part 2 extended).

FMT_LIM.1 Limited capabilities

Hierarchical to: No other components.

FMT_LIM.1.1 The TSF shall be designed in a manner that limits their capabilities so that in conjunction with “Limited availability (FMT_LIM.2)” the following policy is enforced: Deploying Test Features after TOE Delivery does not allow User Data to be disclosed or manipulated, TSF data to be disclosed or manipulated, software to be reconstructed and no substantial information about construction of TSF to be gathered which may enable other attacks.

Dependencies: FMT_LIM.2 Limited availability.

140 The TOE shall meet the requirement “Limited availability (FMT_LIM.2)” as specified below (Common Criteria Part 2 extended).

FMT_LIM.2 Limited availability

Hierarchical to: No other components.

FMT_LIM.2.1 The TSF shall be designed in a manner that limits their availability so that in conjunction with “Limited capabilities (FMT_LIM.1)” the following policy is enforced: Deploying Test Features after TOE Delivery does not allow User Data to be disclosed or manipulated, TSF data to be disclosed or manipulated, software to be reconstructed and no substantial information about construction of TSF to be gathered which may enable other attacks.

Dependencies: FMT_LIM.1 Limited capabilities.

141 The TOE shall meet the requirement “Audit storage (FAU_SAS.1)” as specified below (Common Criteria Part 2 extended).

FAU_SAS.1 Audit storage

Hierarchical to: No other components.

FAU_SAS.1.1 The TSF shall provide the test process before TOE Delivery with the capability to store the Initialisation Data and/or Prepersonalisation Data and/or supplements of the Smartcard Embedded Software in a *Test ROM area*.

Dependencies: No dependencies.

Physical Manipulation and Probing

142 The TOE shall meet the requirement “Resistance to physical attack (FPT_PHP.3)” as specified below.

FPT_PHP.3 Resistance to physical attack

Hierarchical to: No other components.

FPT_PHP.3.1 The TSF shall resist physical manipulation and physical probing to the TSF by responding automatically such that the SFRs are always enforced.

Dependencies:	No dependencies.
Refinement:	The TSF will implement appropriate mechanisms to continuously counter physical manipulation and physical probing. Due to the nature of these attacks (especially manipulation) the TSF can by no means detect attacks on all of its elements. Therefore, permanent protection against these attacks is required ensuring that security functional requirements are enforced. Hence, “automatic response” means here (i) assuming that there might be an attack at any time and (ii) countermeasures are provided at any time.
Application Note:	This requirement is achieved by security feature as the Active shield must be removed and bypassed in order to perform physical intrusive attacks. The TOE makes a reset or FIQ occurs to stops operation if a physical manipulation or physical probing attack is detected. And also Static Address/Data scrambling for bus and memory & Synthesizable processor core make the reverse-engineering of the TOE layout unpractical. So these functionalities meet the security functional requirement of FPT_PHP.3: Resistance to physical attack.

Leakage

143 The TOE shall meet the requirement “Basic internal transfer protection (FDP_ITT.1)” as specified below.

FDP_ITT.1 Basic internal transfer protection

Hierarchical to: No other components.

FDP_ITT.1.1 The TSF shall enforce the Data Processing Policy to prevent the disclosure of user data when it is transmitted between physically-separated parts of the TOE.

Dependencies: [FDP_ACC.1 Subset access control, or FDP_IFC.1 Subset information flow control]

Refinement: The different memories, the CPU and other functional units of the TOE (e.g. a cryptographic co-processor) are seen as physically-separated parts of the TOE.

144 The TOE shall meet the requirement “Basic internal TSF data transfer protection (FPT_ITT.1)” as specified below.

FPT_ITT.1 Basic internal TSF data transfer protection

Hierarchical to: No other components.

FPT_ITT.1.1 The TSF shall protect TSF data from disclosure when it is transmitted between separate parts of the TOE.

Dependencies: No dependencies.

Refinement: The different memories, the CPU and other functional units of the TOE (e.g. a cryptographic co-processor) are seen as separated parts of the TOE.

This requirement is equivalent to FDP_ITT.1 above but refers to TSF data instead of User Data. Therefore, it should be understood as to refer to the same *Data Processing Policy* defined under FDP_IFC.1 below.

- 145 The TOE shall meet the requirement “Subset information flow control (FDP_IFC.1)” as specified below:

FDP_IFC.1 Subset information flow control

Hierarchical to: No other components.

FDP_IFC.1.1 The TSF shall enforce the Data Processing Policy on all confidential data when they are processed or transferred by the TOE or by the Security IC Embedded Software.

Dependencies: FDP_IFF.1 Simple security attributes

- 146 The following Security Function Policy (SFP) **Data Processing Policy** is defined for the requirement “Subset information flow control (FDP_IFC.1)”:

User Data and TSF data shall not be accessible from the TOE except when the Security IC Embedded Software decides to communicate the User Data via an external interface. The protection shall be applied to confidential data only but without the distinction of attributes controlled by the Security IC Embedded Software.

Random Numbers (DRNG)

- 147 The TOE shall meet the requirement “Quality metric for random numbers (FCS_RNG.1)” as specified below (Common Criteria Part 2 extended).

FCS_RNG.1/DRNG Random number generation

Hierarchical to: No other components.

FCS_RNG.1.1/DRNG The TSF shall provide a *deterministic* random number generator that implements *generation of the random numbers*.

FCS_RNG.1.2/DRNG The TSF shall provide random numbers that meet *AIS20 version 1, Functional Classes and Evaluation Methodology for Deterministic Random Number Generators, 2 December 1999, Class K3 requirements*.

Dependencies: No dependencies.

Application Note: The DRNG library version 1.0 functions perform some statically tests to ensure that the DTRNG is working properly. In case those test fail, then an error value is returned and the DTRNG should not be used.

Random Numbers (TRNG)

- 148 The TOE shall meet the requirement “Quality metric for random numbers (FCS_RNG.1)” as specified below (Common Criteria Part 2 extended).

FCS_RNG.1 Random number generation

Hierarchical to: No other components.

FCS_RNG.1.1 The TSF shall provide a physical random number generator that implements total failure test of the random source.

FCS_RNG.1.2	The TSF shall provide random numbers that meet <i>AIS 31 version 1 Functional Classes and Evaluation Methodology for Physical Random Number Generators, 25 September 2001, Class P2</i> .
Dependencies:	No dependencies.
Application Note:	The TRNG library version 1.0 comprises some functions that performs statistical test on the TRNG output in order to ensure that the TRNG is working properly. If test is fails the function return an error value and the TRNG is shuttled down. Those functions are described in TRNG Application note rev 1.0.

Memory access control

- 149 Usage of multiple applications in one Smartcard often requires separating code and data in order to prevent that one application can access code and/or data of another application. To support this the TOE provides Area based Memory Access Control.
- 150 The security service being provided is described in the Security Function Policy (SFP) **Memory Access Control Policy**. The security functional requirement “**Subset access control (FDP_ACC.1)**” requires that this policy is in place and defines the scope were it applies. The security functional requirement “**Security attribute based access control (FDP_ACF.1)**” defines addresses security attribute usage and characteristics of policies. It describes the rules for the function that implements the Security Function Policy (SFP) as identified in FDP_ACC.1. The decision whether an access is permitted or not is taken based upon attributes allocated to the software. The user software defines the attributes and memory areas. The corresponding permission control information is evaluated “on-the-fly” by the hardware so that access is granted/effective or denied/inoperable.
- 151 The security functional requirement “**Static attribute initialization (FMT_MSA.3)**” ensures that the default values of security attributes are appropriately either permissive or restrictive in nature. Alternative values can be specified by any subject provided that the **Memory Access Control Policy** allows that. This is described by the security functional requirement “**Management of security attributes (FMT_MSA.1)**”. The attributes are determined during TOE manufacturing (FMT_MSA.3) or set at run-time (FMT_MSA.1).
- 152 From TOE’s point of view the different roles in the user software can be distinguished according to the memory based access control. However the definition of the roles belongs to the user software.
- 153 The following Security Function Policy (SFP) **Memory Access Control Policy** is defined for the requirement “Security attribute based access control (FDP_ACF.1)”:

Memory Access Control Policy

The TOE shall control *read, write, delete, execute accesses of software running at between two different modes (privilege and user mode) on data including code stored in memory areas*.

The TOE shall restrict the ability to define, to change or at least to finally accept the applied rules (as mentioned in FDP_ACF.1) to *software with privilege mode*.

- 154 The TOE shall meet the requirement “Subset access control (FDP_ACC.1)” as specified below.

FDP_ACC.1 Subset access control

Hierarchical to: No other components.

FDP_ACC.1.1 The TSF shall enforce the *Memory Access Control Policy on all subjects (software with privilege mode and user mode), all objects (data including code stored in memories) and all the operations defined in the Memory Access Control Policy*.

Subjects are software codes in Privilege and User mode.

Object are data stored in ROM, RAM and EEPROM memories.

Dependencies: FDP_ACF.1 Security attribute based access control

- 155 The TOE shall meet the requirement “Security attribute based access control (FDP_ACF.1)” as specified below.

FDP_ACF.1 Security attribute based access control

The attributes are all the operations related to the data stored in memories, which are the *read*, *write*, *delete* and *execute* operations.

Hierarchical to: No other components.

FDP_ACF.1.1 The TSF shall enforce the *Memory Access Control Policy* to objects based on the *memory area where the software is executed from and/or the memory area where the access is performed to and/or the operation to be performed*.

FDP_ACF.1.2 The TSF shall enforce the following rules to determine if an operation among controlled subjects and controlled objects is allowed: *evaluate the corresponding permission control information before the access so that accesses to be denied can not be utilised by the subject attempting to perform the operation*.

FDP_ACF.1.3 The TSF shall explicitly authorise access of subjects to objects based on the following additional rules: *none*.

FDP_ACF.1.4 The TSF shall explicitly deny access of subjects to objects based on the following additional rules: *none*.

Dependencies: FDP_ACC.1 Subset access control
FMT_MSA.3 Static attribute initialisation

- 156 The TOE shall meet the requirement “Static attribute initialisation (FMT_MSA.3)” as specified below.

FMT_MSA.3 Static attribute initialisation

Hierarchical to: No other components.

FMT_MSA.3.1 The TSF shall enforce the *Memory Access Control Policy* to provide *well defined* default values for security attributes that are used to enforce the SFP.

FMT_MSA.3.2 The TSF shall allow *any subject (provided that the Memory Access Control Policy is enforced and the necessary access is therefore allowed)* to specify alternative initial values to override the default values when an object or information is created.

Dependencies: FMT_MSA.1 Management of security attributes
FMT_SMR.1 Security roles

- 157 The TOE shall meet the requirement “Management of security attributes (FMT_MSA.1)” as specified below:

FMT_MSA.1	Management of security attributes
Hierarchical to:	No other components.
FMT_MSA.1.1	The TSF shall enforce the <i>Memory Access Control Policy</i> to restrict the ability to <i>change default, modify or delete</i> the security attributes <i>permission control information to running at privilege mode</i> .
Dependencies:	[FDP_ACC.1 Subset access control or FDP_IFC.1 Subset information flow control] FMT_SMF.1 Specification of management functions FMT_SMR.1 Security roles

158 The TOE shall meet the requirement “Specification of management functions (FMT_SMF.1)” as specified below:

FMT_SMF.1	Specification of management functions
Hierarchical to:	No other components
FMT_SMF.1.1	The TSF shall be capable of performing the following security management functions: <i>access the control registers of the MPU</i> .
Dependencies:	No dependencies

Cryptographic Support

159 FCS_COP.1 Cryptographic operation requires, a cryptographic operation to be performed in accordance with a specified algorithm and with a cryptographic key of specified sizes. The specified algorithm and cryptographic key sizes can be based on an assigned standard.

160 The following additional specific security functionality is implemented in the TOE:

- Triple Data Encryption Standard (3DES) with 112bit or 168bit key size,
- Advanced Encryption Standard(AES) with 128 bit, 192bit and 256bit key size.
- Rivest-Shamir-Adleman (RSA) public key asymmetric cryptography, with key size 1280-bit up to 2048-bit with a granularity of 2 bits (optional)
- Elliptic Curve Cryptography (ECC) (optional)

Note: The TOE can be delivered without the RSA/ECC crypto library. In this case the TOE does not provide the Additional Specific Security Functionality Rivest-Shamir-Adleman Cryptography and Elliptic Curve Cryptography (ECC) and Secure Hash Algorithm (SHA)

Triple-DES Operation

161 The Triple DES (3DES) operation of the TOE shall meet the requirement “Cryptographic operation (FCS_COP.1)” as specified below.

FCS_COP.1/3DES	Cryptographic operation
Hierarchical to:	No other components.
FCS_COP.1.1/3DES	The TSF shall perform <i>encryption and decryption</i> in accordance with a specified cryptographic algorithm <i>Triple Data Encryption Standard (3DES) - ECB mode</i> and cryptographic key sizes <i>112 bit or 168 bit key size</i> that meet the

following standards: [FIPS SP800-67], chapter 2 and 3. TOE implements 3DES with key option 1 and 2 with ECB mode.

Dependencies: [FDP_ITC.1 Import of user data without security attributes or
FDP_ITC.2 Import of user data with security attributes, or
FCS_CKM.1 Cryptographic key generation]
FCS_CKM.4 Cryptographic key destruction

AES Operation

162 The AES operation of the TOE shall meet the requirement “Cryptographic operation (FCS_COP.1)” as specified below.

FCS_COP.1/AES Cryptographic operation

Hierarchical to: No other components.

FCS_COP.1.1/AES The TSF shall perform *encryption and decryption* in accordance with a specified cryptographic algorithm *Advanced Encryption Standard (AES) - ECB mode* and cryptographic key sizes *128bit, 192bit or 256bit key size* that meet the following standard: [PIBS197], chapter 5.

Dependencies: [FDP_ITC.1 Import of user data without security attributes or
FDP_ITC.2 Import of user data with security attributes or
FCS_CKM.1 Cryptographic key generation]
FCS_CKM.4 Cryptographic key destruction

Rivest-Shamir-Adleman (RSA) operation (optional)

163 The RSA/ECC cryptographic library of the TOE shall meet the requirement “Cryptographic operation (FCS_COP.1)” as specified below.

FCS_COP.1/RSA Cryptographic operation

Hierarchical to: No other components

FCS_COP.1.1/RSA The TSF shall *perform the modular exponentiation part of RSA signature generation and verification* in accordance with a specified cryptographic algorithm *Rivest-Shamir-Adleman (RSA:standard RSA and RSA-CRT)* and cryptographic key sizes *from 1280-bit up to 2048-bit with 2-bit granularity* that meet the following standard: [ISO/IEC14888-2:2008] section 6.2 and 6.3.

Note 1: In context of signature generation only the modular exponentiation, i.e. only Step 2 of [ISO14888-2:2008], section 6.2 and in addition the check of the message's length are implemented. Especially the proper use of a format mechanism (including the related hash algorithm) is in the responsibility of the embedded software developer.

Note 2: In context of signature verification only the modular exponentiation, i.e. only the part asking to compute $G^* = S^v \text{ mod } n$ in Step 1 of [ISO/IEC14888-2:2008], section 6.3 is implemented. Especially the proper check of a signatures format (including the related hash algorithm) is in the responsibility of the embedded software developer.

Dependencies: [FDP_ITC.1 Import of user data without security attributes or
FDP_ITC.2 Import of user data with security attributes, or
FCS_CKM.1 Cryptographic key generation]
FCS_CKM.4 Cryptographic key destruction

Elliptic Curve DSA operation (optional)

164 The RSA/ECC library of the TOE of the TOE shall meet the requirement “Cryptographic operation (FCS_COP.1)” as specified below.

FCS_COP.1/ECDSA Cryptographic operation

Hierarchical to: No other components

FCS_COP.1.1/ECDSA The TSF shall perform *signature generation and signature verification* in accordance with a specified cryptographic algorithm *ECDSA* and cryptographic key sizes *from 192bit up to 512bit* that meet the following standard: [ANS X9.62] , section 7.3 *Signing Process* and section 7.4 *Verifying Process*.

Dependencies: [FDP_ITC.1 Import of user data without security attributes or
FDP_ITC.2 Import of user data with security attributes, or
FCS_CKM.1 Cryptographic key generation]
FCS_CKM.4 Cryptographic key destruction

Note1) The RSA/ECC library supports any valid curves over prime fields of size from 192-bit to 512-bit. However standard curves listed below whose security has been proven are in the scope of this evaluation.
1) [NIST curves] : Curves P-192, P-224, P-256, P-384, 2) [Brainpool curves]: brainpoolP192r1, brainpoolP192t1, brainpoolP224r1, brainpoolP224t1, brainpoolP256r1, brainpoolP256t1, brainpoolP320r1, brainpoolP320t1, brainpoolP384r1, brainpoolP384t1, brainpoolP512r1, brainpoolP512t1, 3) [SEC-recommended curves]: secp192k1, secp192r1, secp224k1, secp224r1, secp256k1, secp256r1, secp384r1

Note2) The TOE offers the functionality of hash value computation using SHA-1, SHA-224, SHA-256, SHA-384 and SHA-512. However, only SHA-224, SHA-256, SHA-384 and SHA-512 are in the scope of this evaluation and are intended to be used for signature generation and verification. Note that neither of the functions must be used to hash secret values. In addition, the user is responsible for the truncation or padding of the hash value as required by step e), section 7.3 and step c), section 7.4.1 of above cited standard.

Elliptic Curve DSA Key generation (optional)

165 The key generation for the RSA/ECC library shall meet the requirement “Cryptographic key generation (FCS_CKM.1)” as specified below.

FCS_CKM.1/ECDSA Cryptographic key generation

Hierarchical to: No other components

FCS_CKM.1.1/ECDSA The TSF shall generate cryptographic keys in accordance with a specified cryptographic key generation algorithm specified in [ANS X9.62] and specified cryptographic key sizes *from 192bit up to 512bit* that meet the following standard: [ANS X9.62] , section A.4.3 *Elliptic Curve Key Generation*.

Dependencies: [FCS_CKM.2 Cryptographic key distribution or
FCS_COP.1 Cryptographic operation]
FCS_CKM.4 Cryptographic key destruction

Note1) The RSA/ECC library supports any valid curves over prime fields of size from 192-bit to 512-bit. However standard curves listed below whose security has been proven are in the scope of this evaluation. 1) [NIST curves] : Curves P-192, P-224, P-256, P-384, 2) [Brainpool curves]: brainpoolP192r1, brainpoolP192t1, brainpoolP224r1, brainpoolP224t1, brainpoolP256r1, brainpoolP256t1, brainpoolP320r1, brainpoolP320t1, brainpoolP384r1, brainpoolP384t1, brainpoolP512r1, brainpoolP512t1, 3) [SEC-recommended curves]: secp192k1, secp192r1, secp224k1, secp224r1, secp256k1, secp256r1, secp384r1

Elliptic Curve Diffie-Hellman (ECDH) key agreement (optional)

166 The RSA/ECC library of the TOE shall meet the requirement “Cryptographic operation (FCS_COP.1)” as specified below.

FCS_COP.1/ECDH Cryptographic operation

Hierarchical to: No other components

FCS_COP.1.1/ECDH The TSF shall perform *key exchange* in accordance with a specified cryptographic algorithm *ECDH* and cryptographic key sizes *from 192bit up to 512bit* that meet the following standard: [ANS X9.63], section 5.4.1 *Standard Diffie-Hellman primitive*.

Dependencies: [FDP_ITC.1 Import of user data without security attributes or
FDP_ITC.2 Import of user data with security attributes, or
FCS_CKM.1 Cryptographic key generation]
FCS_CKM.4 Cryptographic key destruction

Note1) The RSA/ECC library supports any valid curves over prime fields of size from 192-bit to 512-bit. However standard curves listed below whose security has been proven are in the scope of this evaluation. 1) [NIST curves] : Curves P-192, P-224, P-256, P-384, 2) [Brainpool curves]: brainpoolP192r1, brainpoolP192t1, brainpoolP224r1, brainpoolP224t1, brainpoolP256r1, brainpoolP256t1, brainpoolP320r1, brainpoolP320t1, brainpoolP384r1, brainpoolP384t1, brainpoolP512r1, brainpoolP512t1, 3)[SEC-recommended curves]: secp192k1, secp192r1, secp224k1, secp224r1, secp256k1, secp256r1, secp384r1

Note2) The implemented routine can be used with ephemeral or static private keys. The base point is assumed to be public.

Note3) For full compatibility the user is responsible to perform step 2 of [ANS X9.63], section 5.2.2.1 prior to using the ECDH_generate function.

Secure Hash Algorithm (SHA) (optional)

167 The Secure Hash Algorithm (SHA) of the TOE shall meet the requirement “Cryptographic operation (FCS_COP.1)” as specified below.

FCS_COP.1/SHA Cryptographic operation

Hierarchical to: No other components

FCS_COP.1.1/SHA The TSF shall perform *secure hash computation* in accordance with a specified cryptographic algorithm *SHA1, SHA224, SHA256, SHA384 and SHA512* and cryptographic key sizes *none* that meet the following standard: [FIPS PUB 180-3].

Note1) The TORNADO™2MX2 RSA/ECC library provides the functionalities for computation of hash values. The use of these functionalities for keyed hash operations like HMAC or similar, is not subject of this TOE and requires specific security improvements and DPA analysis by the operating system which is not part of the TOE. The SHA224, SHA256, SHA384 and SHA512 functionalities are intended to be used for signature generation and verification.

Dependencies: No dependencies

Summary of Security Functional Requirements

Security Functional Requirements
Limited fault tolerance (FRU_FLT.2)
Failure with preservation of secure state (FPT_FLS.1)
Audit storage (FAU_SAS.1)
Limited capabilities(FMT_LIM.1)
Limited availability (FMT_LIM.2)
Resistance to physical attack (FPT_PHP.3)
Basic internal transfer protection (FDP_ITT.1)
Basic internal TSF data transfer protection (FPT_ITT.1)
Subset information flow control (FDP_IFC.1)
Quality metric for random numbers (FCS_RNG.1)

Table 3. Security Functional Requirements defined in Smart Card IC Protection Profile

Security Functional Requirements
Subset access control (FDP_ACC.1)
Security attribute based access control (FDP_ACF.1)
Static attribute initialization (FMT_MSA.3)
Management of security attributes (FMT_MSA.1)
Specification of management functions (FMT_SMF.1)
Cryptographic operation (FCS_COP.1/RSA) (optional)
Cryptographic operation (FCS_COP.1/3DES)

Cryptographic operation (FCS_COP.1/AES)
Cryptographic operation (FCS_COP.1/ECDSA) (optional)
Cryptographic operation (FCS_COP.1/ECDH) (optional)
Cryptographic key generation (FCS_CKM.1/ ECDSA) (optional)
Quality metric for random numbers (FCS_RNG.1/DRNG)
Cryptographic key generation (FCS_COP.1/SHA) (optional)

Table 4. Augmented Security Functional Requirements

6.2 TOE Assurance Requirements

168 The Security Target will be evaluated according to

Security Target evaluation (Class ASE)

169 The TOE Assurance Requirements for the evaluation of the TOE and its development and operating environment are those taken from the

Evaluation Assurance Level 5 (EAL5)

and augmented by the following components

ALC_DVS.2 and AVA_VAN.5

170 corresponding to level “EAL5+”.

171 All refinements from *Protection Profile BSI-PP-0035 version 1.0* for the assurance requirements (ALC_DEL, ALC_DVS, ALC_CMS, ALC_CMC, ADV_ARV, ADV_FSP, ADV_IMP, ATE_COV, AGD_OPE, AGD_PRE and ADV_VAN) have to be taken into consideration. *In particular the document [13] is used in the context of vulnerability analysis*

172

Class ADV: Development

Architectural design	(ADV_ARC.1)
Functional Specification	(ADV_FSP.5)
Implementation Representation	(ADV_IMP.1)
TSF Internals	(ADV_INT.2)
TOE Design	(ADV_TDS.4)

Class AGD: Guidance documents activities

Operational User Guidance	(AGD_OPE.1)
Preparative procedures	(AGD_PRE.1)

Class ALC: Life-cycle support

CM Capabilities	(ALC_CMC.4)
CM Scope	(ALC_CMS.5)
Delivery	(ALC_DEL.1)
<u>Development Security</u>	<u>(ALC_DVS.2)</u>
Life Cycle Definition	(ALC_LCD.1)
Tools and Techniques	(ALC_TAT.2)

Class ASE: Security Target evaluation

Conformance claims	(ASE_CCL.1)
Extended components definition	(ASE_ECD.1)
ST introduction	(ASE_INT.1)

Security objectives	(ASE_OBJ.2)
Derived security requirements	(ASE_REQ.2)
Security problem definition	(ASE_SPD.1)
TOE summary specification	(ASE_TSS.1)

Class ATE: Tests

Coverage	(ATE_COV.2)
Depth	(ATE_DPT.3)
Functional Tests	(ATE_FUN.1)
Independent Testing	(ATE_IND.2)

Class AVA: Vulnerability assessment

<u>Vulnerability Analysis</u>	<u>(AVA_VAN.5)</u>
-------------------------------	--------------------

6.3 Security Requirements Rationale

6.3.1 Rationale for the security functional requirements

173 Table 5 below gives an overview, how the security functional requirements are combined to meet the security objectives. The detailed justification follows after the table.

Objective	TOE Security Functional and Assurance Requirements
O.Leak-Inherent	<ul style="list-style-type: none"> - FDP_ITT.1 "Basic internal transfer protection" - FPT_ITT.1 "Basic internal TSF data transfer protection" - FDP_IFC.1 "Subset information flow control" - AVA_VAN.5 "Advanced methodical vulnerability analysis"
O.Phys-Probing	<ul style="list-style-type: none"> - FPT_PHP.3 "Resistance to physical attack"
O.Malfunction	<ul style="list-style-type: none"> - FRU_FLT.2 "Limited fault tolerance" - FPT_FLS.1 "Failure with preservation of secure state" - ADV_ARC.1 "Architectural Design with domain separation and non-bypassability"
O.Phys-Manipulation	<ul style="list-style-type: none"> - FPT_PHP.3 "Resistance to physical attack"
O.Leak-Forced	<p>All requirements listed for O.Leak-Inherent</p> <ul style="list-style-type: none"> - FDP_ITT.1, FPT_ITT.1, FDP_IFC.1, AVA_VAN.5 <p>plus those listed for O.Malfunction and O.Phys-Manipulation</p> <ul style="list-style-type: none"> - FRU_FLT.2, FPT_FLS.1, FPT_PHP.3, ADV_ARC.1
O.Abuse-Func	<ul style="list-style-type: none"> - FMT_LIM.1 "Limited capabilities" - FMT_LIM.2 "Limited availability" <p>plus those for O.Leak-Inherent, O.Phys-Probing, O.Malfunction, O.Phys-Manipulation, O.Leak-Forced</p> <ul style="list-style-type: none"> - FDP_ITT.1, FPT_ITT.1, FDP_IFC.1, FPT_PHP.3, FRU_FLT.2, FPT_FLS.1, ADV_ARC.1
O.Identification	<ul style="list-style-type: none"> - FAU_SAS.1 "Audit storage"

Objective	TOE Security Functional and Assurance Requirements
O.RND	<ul style="list-style-type: none"> - FCS_RNG.1 "Quality metric for random numbers" plus those for O.Leak-Inherent, O.Phys-Probing, O.Malfunction, O.Phys-Manipulation, O.Leak-Forced - FDP_ITT.1, FPT_ITT.1, FDP_IFC.1, FPT_PHP.3, FRU_FLT.2, FPT_FLS.1, AVA_VAN.5, ADV_ARC.1 - FCS_RNG.1/DRNG "Quality metric for random numbers"
OE.Plat-Appl	not applicable
OE.Resp-Appl	not applicable
OE.Process-Sec-IC	not applicable
O.Mem-Access	<ul style="list-style-type: none"> - FDP_ACC.1 "Subset access control" - FDP_ACF.1 "Security attribute based access control" - FMT_MSA.3 "Static attribute initialisation" - FMT_MSA.1 "Management of security attributes" - FMT_SMF.1 "Specification of Management Functions"
O.Add-Functions	<ul style="list-style-type: none"> - FCS_COP.1 „Cryptographic operation“ - FCS_CKM.1 (ECDSA) (optional)

Table 5: Security Requirements versus Security Objectives

- 174 The justification related to the security objective "Protection against Inherent Information Leakage (O.Leak-Inherent)" is as follows:
- 175 The refinements of the security functional requirements FPT_ITT.1 and FDP_ITT.1 together with the policy statement in FDP_IFC.1 explicitly require the prevention of disclosure of secret data (TSF data as well as User Data) when transmitted between separate parts of the TOE or while being processed. This includes that attackers cannot reveal such data by measurements of emanations, power consumption or other behaviour of the TOE while data are transmitted between or processed by TOE parts.
- 176 Of course this has also to be supported by the Security IC Embedded Software. For example timing attacks were possible if the processing time of algorithms implemented in the software would depend on the content of secret variables.
- 177 The justification related to the security objective "Protection against Physical Probing (O.Phys-Probing)" is as follows:
- 178 The scenario of physical probing as described for this objective is explicitly included in the assignment chosen for the physical tampering scenarios in FPT_PHP.3. Therefore, it is clear that this security functional requirement supports the objective.
- 179 It is possible that the TOE needs additional support by the Security IC Embedded Software (e. g. to send data over certain buses only with appropriate precautions). In this case the combination of the Security IC Embedded Software together with FPT_PHP.3 is suitable to meet the objective.
- 180 The justification related to the security objective "Protection against Malfunctions (O.Malfunction)" is as follows:
- 181 The definition of this objective shows that it covers a situation, where malfunction of the TOE might be caused by the operating conditions of the TOE (while direct manipulation of the TOE is covered O.Phys-Manipulation). There are two possibilities in this situation: Either the operating conditions are

inside the tolerated range or at least one of them is outside of this range. The second case is covered by FPT_FLS.1, because it states that a secure state is preserved in this case. The first case is covered by FRU_FLT.2 because it states that the TOE operates correctly under normal (tolerated) conditions. To support this, the functions implementing FRU_FLT.2 and FPT_FLS.1 must work independently so that their operation can not be affected by the Security IC Embedded Software (refer to the refinement). Therefore, there is no possible instance of conditions under O.Malfunction, which is not covered. The suitability of the implementation is subject of the evaluation of the assurance component ADV_ARC.1

- 182 The justification related to the security objective “Protection against Physical Manipulation (O.Phys-Manipulation)” is as follows:
- 183 The scenario of physical manipulation as described for this objective is explicitly included in the assignment chosen for the physical tampering scenarios in FPT_PHP.3. Therefore, it is clear that this security functional requirement supports the objective.
- 184 It is possible that the TOE needs additional support by the Embedded Software (for instance by implementing FDP_SDL.1 to check data integrity with the help of appropriate checksums). This support must be addressed in the Guidance Documentation. Together with this FPT_PHP.3 is suitable to meet the objective.
- 185 The justification related to the security objective “Protection against Forced Information Leakage (O.Leak-Forced)” is as follows:
- 186 This objective is directed against attacks, where an attacker wants to force an information leakage, which would not occur under normal conditions. In order to achieve this the attacker has to combine a first attack step, which modifies the behaviour of the TOE (either by exposing it to extreme operating conditions or by directly manipulating it) with a second attack step measuring and analysing some output produced by the TOE. The first step is prevented by the same measures which support O.Malfunction and O.Phys-Manipulation, respectively. The requirements covering O.Leak-Inherent also support O.Leak-Forced because they prevent the attacker from being successful if he tries the second step directly.
- 187 The justification related to the security objective “Protection against Abuse of Functionality (O.Abuse-Func)” is as follows:
- 188 This objective states that abuse of functions (especially provided by the IC Dedicated Test Software, for instance in order to read secret data) must not be possible in Phase 7 of the life-cycle. There are two possibilities to achieve this: (i) They cannot be used by an attacker (i. e. its availability is limited) or (ii) using them would not be of relevant use for an attacker (i. e. its capabilities are limited) since the functions are designed in a specific way. The first possibility is specified by FMT_LIM.2 and the second one by FMT_LIM.1. Since these requirements are combined to support the policy, which is suitable to fulfil O.Abuse-Func, both security functional requirements together are suitable to meet the objective.
- 189 Other security functional requirements which prevent attackers from circumventing the functions implementing these two security functional requirements (for instance by manipulating the hardware) also support the objective. The relevant objectives are also listed in Table 0.
- 190 It was chosen to define FMT_LIM.1 and FMT_LIM.2 explicitly (not using Part 2 of the Common Criteria) for the following reason: Though taking components from the Common Criteria catalogue makes it easier to recognise functions, any selection from Part 2 of the Common Criteria would have made it harder for the reader to understand the special situation meant here. As a consequence, the statement of explicit security functional requirements was chosen to provide more clarity.
- 191 The justification related to the security objective “TOE Identification (O.Identification)” is as follows:
- 192 Obviously the operations for FAU_SAS.1 are chosen in a way that they require the TOE to provide the functionality needed for O.Identification. The Initialisation Data (or parts of them) are used for TOE identification. The technical capability of the TOE to store Initialisation Data and/or Pre-personalisation Data is provided according to FAU_SAS.1.

- 193 It was chosen to define FAU_SAS.1 explicitly (not using a given security functional requirement from Part 2 of the Common Criteria) for the following reason: The security functional requirement FAU_GEN.1 in Part 2 of the CC requires the TOE to generate the audit data and gives details on the content of the audit records (for instance data and time). The possibility to use the functions in order to store security relevant data which are generated outside of the TOE, is not covered by the family FAU_GEN or by other families in Part 2. Moreover, the TOE cannot add time information to the records, because it has no real time clock. Therefore, the new family FAU_SAS was defined for this situation.
- 194 The objective must be supported by organisational and other measures, which the TOE Manufacturer has to implement. These measures are a subset of those measures, which are examined during the evaluation of the assurance requirements of the classes AGD, ALC and ADO.
- 195 The justification related to the security objective "Random Numbers (O.RND)" is as follows:
- 196 FCS_RNG.1 and FCS_RNG.1/DRNG requires the TOE to provide random numbers of good quality.
- 197 Other security functional requirements, which prevent physical manipulation and malfunction of the TOE (see the corresponding objectives listed in the table) support this objective because they prevent attackers from manipulating or otherwise affecting the random number generator.
- 198 Random numbers are often used by the Security IC Embedded Software to generate cryptographic keys for internal use. Therefore, the TOE must prevent the unauthorised disclosure of random numbers. Other security functional requirements which prevent inherent leakage attacks, probing and forced leakage attacks ensure the confidentiality of the random numbers provided by the TOE.
- 199 Depending on the functionality of specific TOEs the Security IC Embedded Software will have to support the objective by providing runtime-tests of the random number generator. Together, these requirements allow the TOE to provide cryptographically good random numbers and to ensure that no information about the produced random numbers is available to an attacker.
- 200 The justification related to the security objective "Area based Memory Access Control (O.Mem-Access)" is as follows:
- 201 The security functional requirement "Subset access control (FDP_ACC.1)" with the related Security Function Policy (SFP) "Memory Access Control Policy" exactly require the implementation of an area based memory access control, which is a requirement from O.Mem-Access. Therefore, FDP_ACC.1 with its SFP is suitable to meet the security objective.
- 202 The justification related to the security objective "Additional Specific Security Functionality (O.Add-Functions)" is as follows:
- 203 The security functional requirement(s) "Cryptographic operation (FCS_COP.1)" exactly require those functions to be implemented which are demanded by O.Add-Functions. FCS_CKM.1 supports the generation of ECC keys needed for this cryptographic operations (optional). Therefore, FCS_COP.1 and FCS_CKM.1 are suitable to meet the security objective.
- 204 It was chosen to define FCS_RNG.1 explicitly, because Part 2 of the Common Criteria do not contain generic security functional requirements for Random Number generation. (Note, that there are security functional requirements in Part 2 of the Common Criteria, which refer to random numbers. However, they define requirements only for the authentication context, which is only one of the possible applications of random numbers.)
- 205 The justification related to the security objective "Protection during Packaging, Finishing and Personalisation (OE.Process-Sec-IC)" is as follows:
- 206 The Composite Product Manufacturer has to use adequate measures to fulfil OE.Process-Sec-IC. Depending on the security needs of the application, the Security IC Embedded Software may have to support this for instance by using appropriate authentication mechanisms for personalisation functions.

6.3.2 Dependencies of security functional requirements

207 Table 6 below lists the security functional requirements defined in this Protection Profile, their dependencies and whether they are satisfied by other security requirements defined in this Protection Profile. The text following the table discusses the remaining cases.

Security Functional Requirement	Dependencies	Fulfilled by security requirements
FRU_FLT.2	FPT_FLS.1	Yes
FPT_FLS.1	None	No dependency
FMT_LIM.1	FMT_LIM.2	Yes
FMT_LIM.2	FMT_LIM.1	Yes
FAU_SAS.1	None	No dependency
FPT_PHP.3	None	No dependency
FDP_ITT.1	FDP_ACC.1 or FDP_IFC.1	Yes
FDP_IFC.1	FDP_IFF.1	See discussion below
FPT_ITT.1	None	No dependency
FCS_RNG.1	None	No dependency
FCS_RNG.1/DRNG	None	No dependency

Security Functional Requirement	Dependencies	Fulfilled by security requirements
FCS_COP.1 /3DES	FCS_CKM.1	Yes (by the environment)
	FDP_ITC.1 or FDP_ITC.2 (if not FCS_CKM.1) FCS_CKM.4	Yes (by the environment)
FCS_COP.1 /AES	FCS_CKM.1	Yes (by the environment)
	FDP_ITC.1 or FDP_ITC.2 (if not FCS_CKM.1) FCS_CKM.4	Yes (by the environment)
FCS_COP.1 /RSA (optional)	FCS_CKM.1	Yes (by the environment)
	FDP_ITC.1 or FDP_ITC.2 (if not FCS_CKM.1) FCS_CKM.4	Yes (by the environment)
FCS_COP.1 (ECDSA) (optional)	FCS_CKM.1	Yes (additionally it can be fulfilled by the environment)
	FDP_ITC.1 or FDP_ITC.2 (if not FCS_CKM.1) FCS_CKM.4 FMT_MSA.2	Yes (by the environment)
FCS_COP.1 (ECDH) (optional)	FCS_CKM.1	Yes (additionally it can be fulfilled by the environment)
	FDP_ITC.1 or FDP_ITC.2 (if not FCS_CKM.1) FCS_CKM.4 FMT_MSA.2	Yes (by the environment)
FDP_ACC.1	FDP_ACF.1	Yes
FDP_ACF.1	FDP_ACC.1 FMT_MSA.3	Yes Yes
FMT_MSA.3	FMT_MSA.1 FMT_SMR.1	Yes See discussion below
FMT_MSA.1	FDP_ACC.1 or FDP_IFC.1 FMT_SMR.1 FMT_SMF.1	Yes See discussion below Yes
FMT_SMF.1	None	No dependency
FCS_CKM.1(ECDSA) (optional)	FCS_COP.1 or FCS_CKM.2 FCS_CKM.4 FMT_MSA.2	Yes See discussion below See discussion below
FCS_COP.1/SHA (optional)	None	No dependency

Table 6: Dependencies of the Security Functional Requirements

- 208 Part 2 of the Common Criteria defines the dependency of FDP_IFC.1 (information flow control policy statement) on FDP_IFF.1 (Simple security attributes). The specification of FDP_IFF.1 would not capture the nature of the security functional requirement nor add any detail. As stated in the *Data Processing Policy* referred to in FDP_IFC.1 there are no attributes necessary. The security functional requirement for the TOE is sufficiently described using FDP_ITT.1 and its *Data Processing Policy* (FDP_IFC.1). Therefore the dependency is considered satisfied.
- 209 As Table 5 shows, all other dependencies are fulfilled by security requirements defined in this Protection Profile.
- 210 In particular the security functional requirements providing resistance of the hardware against manipulations (e. g. FPT_PHP.3) support all other more specific security functional requirements (e. g. FCS_RNG.1) because they prevent an attacker from disabling or circumventing the latter. Together with the discussion of the dependencies above this shows that the security functional requirements build a mutually supportive whole.
- 211 The dependency FMT_SMR.1 introduced by the two components FMT_MSA.1 and FMT_MSA.3 is considered to be satisfied because the access control specified for the intended TOE is not role-based but enforced for each subject. Therefore, there is no need to identify roles in form of a security functional requirement FMT_SMR.1.

6.3.3 Rationale for the Assurance Requirements

- 212 The assurance level EAL5 and the augmentation with the requirements ALC_DVS.2, and AVA_VAN.5 were chosen in order to meet assurance expectations explained in the following paragraphs.
- 213 An assurance level of EAL5 is required for this type of TOE since it is intended to defend against sophisticated attacks. This evaluation assurance level was selected since it is designed to permit a developer to gain maximum assurance from positive security engineering based on good commercial practices. In order to provide a meaningful level of assurance that the TOE provides an adequate level of defence against such attacks, the evaluators should have access to the low level design and source code.

ALC_DVS.2 Sufficiency of security measures

- 214 Development security is concerned with physical, procedural, personnel and other technical measures that may be used in the development environment to protect the TOE.
- 215 In the particular case of a Security IC the TOE is developed and produced within a complex and distributed industrial process which must especially be protected. Details about the implementation, (e.g. from design, test and development tools as well as Initialization Data) may make such attacks easier. Therefore, in the case of a Security IC, maintaining the confidentiality of the design is very important.
- 216 This assurance component is a higher hierarchical component to EAL5 (which only requires ALC_DVS.1). ALC_DVS.2 has no dependencies.

AVA_VAN.5 Advanced methodical vulnerability analysis

- 217 Due to the intended use of the TOE, it must be shown to be highly resistant to penetration attacks. This assurance requirement is achieved by the AVA_VAN.5 component.
- 218 Independent vulnerability analysis is based on highly detailed technical information. The main intent of the evaluator analysis is to determine that the TOE is resistant to penetration attacks performed by an attacker possessing high attack potential.
- 219 AVA_VAN.5 has dependencies to ADV_ARC.1 "Security Architectural Design", ADV_FSP.2 "Security-enforcing functional specification", ADV_TDS.3 "Basic modular design", ADV_IMP.1

“Implementation representation of the TSF”, AGD_OPE.1 “Operational user guidance”, AGD_PRE.1 “Preparative procedures”.

- 220 All these dependencies are satisfied by EAL5.
- 221 It has to be assumed that attackers with high attack potential try to attack Security ICs like smart cards used for digital signature applications or payment systems. Therefore, specifically AVA_VAN.5 was chosen in order to assure that even these attackers cannot successfully attack the TOE.

6.3.4 Security Requirements are Internally Consistent

- 222 The discussion of security functional requirements and assurance components in the preceding sections has shown that mutual support and consistency are given for both groups of requirements. The arguments given for the fact that the assurance components are adequate for the functionality of the TOE also shows that the security functional requirements and assurance requirements support each other and that there are no inconsistencies between these groups.
- 223 The security functional requirement FPT_PHP.3 makes it harder to manipulate data. This protects the primary assets and other security features or functionality which use these data.
- 224 Though a manipulation of the TOE (refer to FPT_PHP.3) is not of great value for an attacker in itself, it can be an important step in order to threaten the primary assets. Therefore, the security functional requirement FPT_PHP.3 is not only required to meet the security objective O.Phys-Manipulation. Instead it protects other security features or functions of both the TOE and the Security IC Embedded Software from being bypassed, deactivated or changed. In particular this may pertain to the security features or functions being specified using FDP_ITT.1, FPT_ITT.1, FPT_FLS.1, FMT_LIM.2, FCS_RNG.1, and those implemented in the Security IC Embedded Software.
- 225 A malfunction of TSF (refer to FRU_FLT.2 and FPT_FLS.1) can be an important step in order to threaten the primary assets. Therefore, the security functional requirements FRU_FLT.2 and FPT_FLS.1 are not only required to meet the security objective O.Malfunction. Instead they protect other security features or functions of both the TOE and the Security IC Embedded Software from being bypassed, deactivated or changed. In particular this pertains to the security features or functions being specified using FDP_ITT.1, FPT_ITT.1, FMT_LIM.1, FMT_LIM.2, FCS_RNG.1, and those implemented in the Security IC Embedded Software.
- 226 In a forced leakage attack the methods described in “Malfunction due to Environmental Stress” (refer to T.Malfunction) and/or “Physical Manipulation” (refer to T.Phys-Manipulation) are used to cause leakage from signals which normally do not contain significant information about secrets. Therefore, in order to avert the disclosure of primary assets it is important that the security functional requirements averting leakage (FDP_ITT.1, FPT_ITT.1) and those against malfunction (FRU_FLT.2 and FPT_FLS.1) and physical manipulation (FPT_PHP.3) are effective and bind well. The security features and functions against malfunction ensure correct operation of other security functions (refer to above) and help to avert forced leakage themselves in other attack scenarios. The security features and functions against physical manipulation make it harder to manipulate the other security functions (refer to above).
- 227 Physical probing (refer to FPT_PHP.3) shall directly avert the disclosure of primary assets. In addition, physical probing can be an important step in other attack scenarios if the corresponding security features or functions use secret data. For instance the security functional requirement FMT_LIM.2 may use passwords. Therefore, the security functional requirement FPT_PHP.3 (against probing) help to protect other security features or functions including those being implemented in the Security IC Embedded Software. Details depend on the implementation.
- 228 Leakage (refer to FDP_ITT.1, FPT_ITT.1) shall directly avert the disclosure of primary assets. In addition, inherent leakage and forced leakage (refer to above) can be an important step in other attack scenarios if the corresponding security features or functions use secret data. For instance the security functional requirement FMT_LIM.2 may use passwords. Therefore, the security functional requirements FDP_ITT.1 and FPT_ITT.1 help to protect other security features or functions

implemented in the Security IC Embedded Software (FDP_ITT.1) or provided by the TOE (FPT_ITT.1). Details depend on the implementation.

- 229 According to the assumption Usage of Hardware Platform (A.Plat-Appl) the Security IC Embedded Software will correctly use the functions provided by the TOE. Hereby the User Data are treated as required to meet the requirements defined for the specific application context (refer to Treatment of User Data (A.Resp-Appl)). However, the TOE may implement additional functions. This can be a risk if their interface can not completely be controlled by the Security IC Embedded Software. Therefore, the security functional requirements FMT_LIM.1 and FMT_LIM.2 are very important. They ensure that appropriate control is applied to the interface of these functions (limited availability) and that these functions, if being usable, provide limited capabilities only.
- 230 The combination of the security functional requirements FMT_LIM.1 and FMT_LIM.2 ensures that (especially after TOE Delivery) these additional functions can not be abused by an attacker to (i) disclose or manipulate User Data, (ii) to manipulate (explore, bypass, deactivate or change) security features or functions of the TOE or of the Security IC Embedded Software or (iii) to enable an attack. Hereby the binding between these two security functional requirements is very important:
- 231 The security functional requirement Limited Capabilities (FMT_LIM.1) must close gaps which could be left by the control being applied to the function's interface (Limited Availability (FMT_LIM.2)). Note that the security feature or function which limits the availability can be bypassed, deactivated or changed by physical manipulation or a malfunction caused by an attacker. Therefore, if Limited Availability (FMT_LIM.2) is vulnerable, it is important to limit the capabilities of the functions in order to limit the possible benefit for an attacker.
- 232 The security functional requirement Limited Availability (FMT_LIM.2) must close gaps which could result from the fact that the function's kernel in principle would allow to perform attacks. The TOE must limit the availability of functions which potentially provide the capability to disclose or manipulate User Data, to manipulate security features or functions of the TOE or of the Security IC Embedded Software or to enable an attack. Therefore, if an attacker could benefit from using such functions, it is important to limit their availability so that an attacker is not able to use them.
- 233 No perfect solution to limit the capabilities (FMT_LIM.1) is required if the limited availability (FMT_LIM.2) alone can prevent the abuse of functions. No perfect solution to limit the availability (FMT_LIM.2) is required if the limited capabilities (FMT_LIM.1) alone can prevent the abuse of functions. Therefore, it is correct that both requirements are defined in a way that they together provide sufficient security.
- 234 It is important to avert malfunctions of TSF and of security functions implemented in the Security IC Embedded Software (refer to above). There are two security functional requirements which ensure that malfunctions can not be caused by exposing the TOE to environmental stress. First it must be ensured that the TOE operates correctly within some limits (Limited fault tolerance (FRU_FLT.2)). Second the TOE must prevent its operation outside these limits (Failure with preservation of secure state (FPT_FLS.1)). Both security functional requirements together prevent malfunctions. The two functional requirements must define the "limits". Otherwise there could be some range of operating conditions which is not covered so that malfunctions may occur. Consequently, the security functional requirements Limited fault tolerance (FRU_FLT.2) and Failure with preservation of secure state (FPT_FLS.1) are defined in a way that they together provide sufficient security.
- 235 Two refinements from the PP [5] have to be discussed here in the ST as the assurance level is increased. The refinement for ALC_CMS from the PP [5] can even be applied at the assurance level EAL 5 augmented with ALC_CMS.5. The assurance component ALC_CMS.4 is augmented to ALC_CMS.5 with aspects regarding the configuration control system for the TOE. The refinement is not touched. The refinement for ADV_FSP from the PP [5] can even be applied at the assurance level EAL 5 augmented with ADV_FSP.5. The assurance component ADV_FSP.4 is extended to ADV_FSP.5 with aspects regarding the description level. The level is increased from informal to semi-formal with informal description. The refinement is not touched by this measure

7 TOE SUMMARY SPECIFICATION

236 This chapter 7 TOE Summary Specification contains the following sections:

7.1 List of Security Functional Requirements

7.1 List of Security Functional Requirements

SFR1: FPT_FLS.1: Failure with preservation of secure state

237 The detection thresholds of **TOE's detectors** are inside the operating range of the TOE. Therefore abnormal events/failures are detected before the secure state is compromised. This allows to take User's defined appropriate actions by software or to immediately RESET the TOE.

238 The secure state is maintained by TOE's detectors. The TOE's detectors are monitoring the failure occurs. The failures are abnormal frequency, abnormal voltage, abnormal temperature, and power glitch detectors that detect out of the specified range. If the failures are happen, the TOE goes into RESET state. This satisfies the FPT_FLS.1 "Failure with preservation of secure state."

TOE's Detectors

239 These functions records in register the events notified by the detectors (refer to list below). The software configures the reaction in case of detection:

- The TOE is immediately reset when an event is detected.
- Or, a special function register bit is set.

List of detectors:

- Abnormal frequency Detector
- Abnormal voltage Detector
- Abnormal temperature Detector
- Light Detector
- Inner insulation removal Detector
- Active shield removal Detector
- Glitch Detector

SFR2: FRU_FLT.2: Limited fault tolerance

240 All operating signals (Clock, RESET and supply voltage) are filtered/regulated in order to prevent malfunction.

TOE's Filters

241 These filters are used for preventing noise, glitches and extremely high frequency in the external reset or clock pad from causing undefined or unpredictable behavior of the chip.

- High Frequency Filter
- Reset Noise Filter

242 TOE's filters and detectors are implemented by the hardware. The filtering and detection cannot be affected or bypassed by Smartcard Embedded Software. The reaction to the detection can be configured by the software. The influence on security and the way how to configure it is described in details in the S3CT9KW *User's Manual*. Therefore, FRU_FLT.2 is implemented by TOE.

243 Security domains are maintained since accesses to the access-prohibited area are trapped by this access control function.

SFR3: FPT_PHP.3: Resistance to physical attacks

244 This requirement is achieved by security feature as the Active shield must be removed and bypassed in order to perform physical intrusive attacks. The TOE makes a reset or FIQ occurs to stops operation if a physical manipulation or physical probing attack is detected. And also Static Address/Data scrambling for bus and memory & Synthesizable processor core make the reverse-engineering of the TOE layout unpractical. So these functionalities meet the security functional requirement of FPT_PHP.3: Resistance to physical attack.

245 **Static Address/Data scrambling for bus and memory** protects memory and address/data bus from probing attacks.

246 **Synthesizable processor core:** The Central Processing Unit (CPU) of the TOE is synthesizable with glue logic, which makes reverse engineering and signal identification more difficult.

SFR4: FDP_ACC.1: Subset access control

247 This requirement is achieved by security register access control, invalid address access and access right for the code executed in EEPROM.

248 **1) Security registers access control:** This security function manages access to the security control registers through access control security attributes.

249 **2) Invalid address access:** This function detects invalid address access occurrence. In case of an invalid address access is detected, an FIQ is evoked.

250 **3) Access rights for the code executed in EEPROM:** This security function manages the code execution in EEPROM, through access control security attributes. If an invalid access is detected, then a FIQ occurs.

SFR5: FDP_ACF.1: Security attributes based access control.

251 This is covered by the Privilege and User modes of the TOE.

SFR6: FMT_MSA.3: Static attribute initialization.

252 All Special Function Registers including MPU have DEFAULT values after Power on Reset.

SFR7: FMT_MSA.1: Management of security attributes.

253 This is achieved with the MPU feature. The Memory Protection Unit (MPU) enables user to partition memory and set individual protection attributes for each partition. This allows the operating system to control the memory regions accessible by a User mode application process.

SFR8: FMT_SMF.1: Specification of management functions.

254 This is achieved via access to Special Function Registers.

SFR9: FAU_SAS.1: Audit Storage

255 This is fulfilled by the traceability/identification data written once and for all during the TEST mode of the manufacturing process.

- 1) **Non-reversibility of TEST mode and NORMAL mode:** This function disables the TEST mode and enables the NORMAL mode of the TOE. This function ensures the non-reversibility of the NORMAL mode. This function is used once during the manufacturing process.
- 2) **TEST mode communication protocol and data commands:** This function is the proprietary protocol used to operate the chip in TEST mode. This function enforces the identification and authentication of the TEST administrator during the test phase of the manufacturing process.
- 3) **Functional Tests:** During the manufacturing process, the operation of the TOE and the embedded software checksum are verified. This security function ensures the correct operation of the TOE security functions and the integrity of the embedded software.
- 4) **Identification:** During the TEST mode of manufacturing process, traceability data are written in the non-volatile memory of the TOE.

SFR10: FMT LIM.1: Limited capabilities

- 256 TEST mode can be accessed only by the TEST administrator by supplying an authentication password through a proprietary protocol. Once the TOE is changed to NORMAL mode, TEST mode functions are no more available for NORMAL mode.

SFR11: FMT LIM.2: Limited availabilities

- 257 TEST mode can be accessed only by the TEST administrator by supplying an authentication password through a proprietary protocol. Once the TOE is changed to NORMAL mode, TEST mode commands are no more available for NORMAL mode. Functional test during manufacturing process is only available for TEST mode only.

SFR12: FDP IFC.1: Subset information flow control

- 258 **Memory Encryption:** This is achieved by the function protects the memory contents of the TOE from data analysis on the stored data as well as on internally transmitted data.

SFR13: FDP ITT.1: Basic internal transfer protection

- 259 This requirement is achieved by the combination of the TOE security features TOE features 1) to 4) as it is impractical to get access to internal signals and interpret them.
- 1) **Static Address/Data scrambling for bus and memory:** This function protects memory and address/data bus from probing attacks.
 - 2) **Memory encryption:** This security function protects the memory contents of the TOE from data analysis on the stored data as well as on internally transmitted data.
 - 3) **Synthesizable processor core:** The Central Processing Unit (CPU) of the TOE is synthesizable with glue logic, which makes reverse engineering and signal identification more difficult.
- 260 4) **De-synchronization and signal-to-noise ratio reduction mechanisms:** The TOE operations can be made asynchronous by using the Internal Variable Clock, Random Current Generator and the Random Wait Generator security features. They make a full range of intrusive (e.g. probing attacks) and non intrusive attacks (e.g. side-channel attacks) more complex and difficult.

SFR14: FPT ITT.1: Basic internal TSF data transfer protection

- 261 This requirement is achieved by the combination of the TOE security features TOE features 1) to 4) as it is impractical to get access to internal signals and interpret them.
- 1) **Static Address/Data scrambling for bus and memory:** This function protects memory and address/data bus from probing attacks.

2) **Memory encryption:** This security function protects the memory contents of the TOE from data analysis on the stored data as well as on internally transmitted data.

3) **Synthesizable processor core:** The Central Processing Unit (CPU) of the TOE is synthesizable with glue logic, which makes reverse engineering and signal identification more difficult.

262 4) **De-synchronization and signal-to-noise ratio reduction mechanisms:** The TOE operations can be made asynchronous by using the Internal Variable Clock, Random Current Generator and the Random Wait Generator security features. They make a full range of intrusive (e.g. probing attacks) and non intrusive attacks (e.g. side-channel attacks) more complex and difficult.

SFR15: FCS_RNG.1: Random number generation

263 This requirement is ensured by the design of the random number generation algorithm that follows the requirements and the metric of the *AIS20* Class K3 standard (FCS_RNG.1/DRNG) and a True Random Number Generator (TRNG) for *AIS31 Class P2*-compliant Random Number Generation(FCS_RNG.1).

SFR16: FCS_COP.1: Cryptographic operation

264 This requirement is covered by the TOE.

Triple Data Encryption Standard Engine

265 This function is used for encrypting and decrypting data using the Triple DES symmetric algorithm with 112bit or 168bit key size. (FCS_COP.1/3DES)

TORNADO™2MX2 RSA Cryptographic Library as part of Secure RSA/ECC library (optional)

266 This function assists in the acceleration of modulo exponentiations required in the RSA encryption/decryption algorithm. (FCS_COP.1/RSA)

267 TORNADO™2MX2 is a high speed modular multiplication coprocessor for RSA public key asymmetric cryptographic support. The TORNADO™2MX2 RSA Library is the software built on the TORNADO™2MX2 coprocessor that provides high level interface for RSA based algorithms. The functions of the library included in the evaluation are:

- TND_RSA_SigSTD_Secure (RSA signature generation with the standard method)
This function performs the RSA signature generation with the standard method. It implements several countermeasures against the timing attack, SPA, the differential power analysis attack (DPA) and the fault injection attack.
- TND_RSA_SigCRT_Secure (RSA signature generation with CRT method)
This function performs the RSA signature generation with the CRT method. It implements several countermeasures against the timing attack, SPA, DPA and the fault injection attack.
- TND_RSA_Verify (RSA signature verification)
This function performs the RSA signature verification. Since this function uses only the public information, it does not implement any dedicated countermeasures.

268 The TND_RSA_SigSTD_Secure and TND_RSA_SigCRT_Secure have some countermeasure against the timing attack, SPA, DPA and the fault attack.

TORNADO™2MX2 ECC Cryptographic Library as part of Secure RSA/ECC library (optional)

269 This function assists in the acceleration of required in the ECC signature generation and signature verification algorithm. (FCS_COP.1/ECDSA and FCS_COP.1/ECDH)

270 TORNADO™2MX2 RSA/ECC library provides a set of functions to implement elliptic curve cryptography algorithms. In particular, it provides some functions to implement the ECDSA signature generation and the ECDH key exchange protocol.

271 The functions of the library included in the evaluation are:

- ECDSA_sign_digest

Generate the ECDSA signature for the given message digest..

- ECDSA_verify_digest

Verify the given ECDSA (digested) message/signature pair.

- ECDH_generate

Generate a shared secret value for the ECDH key exchange protocol. It implements several countermeasures against the timing attack, SPA, DPA and the fault attack.

The TORNADO™2MX2 Secure RSA/ECC library provides the functions for calculating hash (digest) values using the SHA1, SHA224, SHA256, SHA384 and SHA 512 algorithm as specified in [FIPS PUB 180-3], but only the functions related to SHA224, SHA256, SHA384 and SHA 512 are in the scope of this evaluation:

- SHA1_init, SHA1_update, SHA1_final,
- SHA224_init, SHA224_update, SHA224_final,
- SHA256_init, SHA256_update, SHA256_final.
- SHA384_init, SHA384_update, SHA384_final.
- SHA512_init, SHA512_update, SHA512_final.

These functions are not security relevant functions, i.e. they must not be used to hash security values like keys etc. There are implemented no countermeasures against side channel attacks. The TOE provides the functionality of hash computation if and only if the optional TORNADO™2MX2 Secure RSA/ECC library is delivered.

AES (Advanced Encryption Standard)

272 This function supports the AES operation with 128 bit, 192bit and 256bit key size. (FCS_COP.1/AES)

SFR17: FCS_CKM.1: Cryptographic key generation

273 This requirement is covered by the TOE for ECC key generation. (optional)

274 ECDSA_keygen - FCS_CKM.1/ECDSA.

Generate an ephemeral public/private key for the ECDSA signature generation. It implements several countermeasures against the timing attack, SPA and the fault attack

8 ANNEX

8.1 Glossary

Application Data

All data managed by the Security IC Embedded Software in the application context. Application data comprise all data in the final Security IC.

Composite Product Integrator

Role installing or finalising the IC Embedded Software and the applications on platform transforming the TOE into the unpersonalised Composite Product after TOE delivery. The TOE Manufacturer may implement IC Embedded Software delivered by the Security IC Embedded Software Developer before TOE delivery (e.g. if the IC Embedded Software is implemented in ROM or is stored in the non-volatile memory as service provided by the IC Manufacturer or IC Packaging Manufacturer)

Composite Product Manufacturer

The Composite Product Manufacturer has the following roles (i) the Security IC Embedded Software Developer (Phase 1), (ii) the Composite Product Integrator (Phase 5) and (iii) the Personaliser (Phase 6). If the TOE is delivered after Phase 3 in form of wafers or sawn wafers (dice) he has the role of the IC Packaging Manufacturer (Phase 4) in addition.

End-consumer

User of the Composite Product in Phase 7.

IC Dedicated Software

IC proprietary software embedded in a Security IC (also known as IC firmware) and developed by the IC Developer. Such software is required for testing purpose (IC Dedicated Test Software) but may provide additional services to facilitate usage of the hardware and/or to provide additional services (IC Dedicated Support Software)..

IC Dedicated Test Software

That part of the IC Dedicated Software (refer to above) which is used to test the TOE before TOE Delivery but which does not provide any functionality thereafter.

IC Dedicated Support Software

That part of the IC Dedicated Software (refer to above) which provides functions after TOE Delivery. The usage of parts of the IC Dedicated Software might be restricted to certain phases.

Initialisation Data

Initialisation Data defined by the TOE Manufacturer to identify the TOE and to keep track of the Security IC's production and further life-cycle phases are considered as belonging to the TSF data. These data are for instance used for traceability and for TOE identification (identification data).

Integrated Circuit (IC)

Electronic component(s) designed to perform processing and/or memory functions.

Pre-personalisation Data

Any data supplied by the Card Manufacturer that is injected into the non-volatile memory by the Integrated Circuits manufacturer (Phase 3). These data are for instance used for traceability and/or to secure shipment between phases.

Security IC

Composition of the TOE, the Security IC Embedded Software, User Data and the package (the Security IC carrier).

Security IC Embedded Software

Software embedded in a Security IC and normally not being developed by the IC Designer. The Security IC Embedded Software is designed in Phase 1 and embedded into the Security IC in Phase 3 or in later phases of the Security IC product life-cycle. Some part of that software may actually implement a Security IC application others may provide standard services. Nevertheless, this distinction doesn't matter here so that the Security IC Embedded Software can be considered as being application dependent whereas the IC Dedicated Software is definitely not.

Security IC Product

Composite product which includes the Security Integrated Circuit (i.e. the TOE) and the Embedded Software and is evaluated as composite target of evaluation in the sense of the Supporting Document

TOE Delivery

The period when the TOE is delivered which is either (i) after Phase 3 (or before Phase 4) if the TOE is delivered in form of wafers or sawn wafers (dice) or (ii) after Phase 4 (or before Phase 5) if the TOE is delivered in form of packaged products.

TOE Manufacturer

The TOE Manufacturer must ensure that all requirements for the TOE and its development and production environment are fulfilled. The TOE Manufacturer has the following roles: (i) IC Developer (Phase 2) and (ii) IC Manufacturer (Phase 3). If the TOE is delivered after Phase 4 in form of packaged products, he has the role of the (iii) IC Packaging Manufacturer (Phase 4) in addition.

TSF data

Data created by and for the TOE, that might affect the operation of the TOE. This includes information about the TOE's configuration, if any is coded in non-volatile non-programmable memories (ROM), in specific circuitry, in non-volatile programmable memories (for instance E2PROM) or a combination thereof.

User data

All data managed by the Smartcard Embedded Software in the application context. User data comprise all data in the final Smartcard IC except the TSF data.

8.2 Abbreviations

CC

Common Criteria

EAL

Evaluation Assurance Level

IT

Information Technology

PP

Protection Profile

ST

Security Target

TOE

Target of Evaluation

TSC

TSF Scope of Control

TSF

TOE Security Functionality

TSFI

TSF Interface

TSP

TOE Security Policy

8.3 Literature

- [1] Common Criteria, Part 1: Common Criteria for Information Technology Security Evaluation, Part 1: Introduction and General Model, Version 3.1, Revision 3, July 2009, CCMB-2009-07-001
- [2] Common Criteria, Part 2: Common Criteria for Information Technology Security Evaluation, Part 2: Security Functional Components, Version 3.1, Revision 3, July 2009, CCMB-2009-07-002
- [3] Common Criteria, Part 3: Common Criteria for Information Technology Security Evaluation, Part 3: Security Assurance Components, Version 3.1, Revision 3, July 2009, CCMB-2009-07-003
- [4] Common Methodology for Information Technology Security Evaluation, Evaluation Methodology, Version 3.1, Revision 3, July 2009, CCMB-2009-07-004
- [5] Eurosmart Security IC Platform Protection Profile, Version 1.0, June 2007, BSI-PP-0035.
- [6] AIS31: Functionality classes and evaluation methodology for true (physical) random number generators, Version 1, 25.09.2001, Bundesamt für Sicherheit in der Informationstechnik
- [7] AIS20: Functionality classes and evaluation methodology for deterministic random number generators, Version 1, 2.12.1999, Bundesamt für Sicherheit in der Informationstechnik
- [8] ALGO: *Federal Gazette No 19, Notification in accordance with the Electronic Signatures Act and the Electronic Signatures Ordinance (overview of suitable algorithms)*, Federal Network Agency for Electricity, Gas, Telecommunications, Post and Railway, 2008-11-17
- [10] [FIPS SP800-67] *Recommendation for the Triple Data Encryption Algorithm (TDEA) Block Cipher, version 1.1*
- [11] [FIPS 197] *Advanced Encryption Standard (AES), 2001-11-26*
- [12] [ISO/IEC 14888-2:2008] - *Information technology -- Security techniques-- Digital signatures with appendix -- Part 2: Integer factorization based mechanisms.*
- [13] *CC Supporting Document, Mandatory Technical Document, Application of Attack Potential to Smartcards, Version 2.5, Revision 1, April 2008, CCDB-2008-04-001*
- [14] [ANS X9.62] *American National Standard X9.62-2005, Public Key Cryptography for the Financial Services Industry, The Elliptic Curve Digital Signature Algorithm (ECDSA)*, November 16, 2005.
- [15] [ANS X9.63] *American National Standard X9.63-2001, Public Key Cryptography for the Financial Services Industry: Key Agreement and Key Transport Using Elliptic Curve Cryptography*, November 20, 2001
- [16] [FIPS PUB 180-3] *U.S. Department of Commerce / National Bureau of Standards, Secure Hash Algorithm, FIPS PUB 180-3, 2008-October*
- [17] [Brainpool curves] *ECC Brainpool Standard Curves and Curve generation*, M. Lochter, v1.0, www.ecc-brainpool.org
- [18] [NIST curves] *Federal Information Processing Standards Publication FIPS PUB 180-3, Digital Signature Standard*; U.S. department of Commerce / National Institute of Standards and Technology (NIST), June 2009
- [19] [SEC-recommended curves] *SEC2: Recommended Elliptic Curve Domain Parameters*, Certicom Research, v1.0, September 20, 2000.