	Reference D1226479	Release 1.3p <small>(Printed copy not controlled: verify the version before using)</small>
	Classification level Public	Pages 177

Security Target



Orange NFC V2 G1 card



	Reference	D1226479	Release	1.3p
			<small>(Printed copy not controlled: verify the version before using)</small>	
	Classification level	Public	Pages	177

Table of Contents

1	ST INTRODUCTION	7
1.1	ST REFERENCE	7
1.2	TOE REFERENCE	8
1.3	TOE OVERVIEW	8
1.3.1	<i>TOE Type</i>	8
1.3.2	<i>TOE usage</i>	9
1.3.3	<i>TOE Boundaries</i>	10
1.3.4	<i>TOE Description</i>	11
1.3.5	<i>TOE Life Cycle</i>	13
1.3.6	<i>TOE Environment</i>	15
1.3.6.1	TOE Development Environment & Roles	16
1.3.6.2	TOE Manufacturing Environment	16
1.3.6.3	TOE Personalization Environment	16
1.3.6.4	TOE User Environment	16
1.3.7	<i>Actors of the TOE</i>	17
1.3.8	<i>TOE Security Features</i>	17
1.3.8.1	Security services to applications	17
1.3.8.2	Application Management	18
1.3.9	<i>Non-TOE HW/SW/FW Available to the TOE</i>	18
2	CONFORMANCE CLAIMS	19
2.1	CC CONFORMANCE CLAIMS	19
2.2	PP CONFORMANCE CLAIMS	19
2.3	CONFORMANCE RATIONALE	19
3	SECURITY PROBLEM DEFINITION	26
3.1	ASSETS	26
3.1.1	<i>(U)SIM Java card TM Platform Protection Profile</i>	26
3.1.1.1	Basic TOE	26
3.1.2	<i>Java Card System Protection Profile - Open Configuration</i>	27
3.1.2.1	User data	27
3.1.2.2	TSF data	28
3.1.3	<i>(U)SIM</i>	29
3.2	USERS / SUBJECTS	29
3.2.1	<i>(U)SIM Java card TM Platform Protection Profile</i>	29
3.2.1.1	Basic TOE	29
3.2.2	<i>Java Card System Protection Profile - Open Configuration</i>	29
3.3	THREATS	29
3.3.1	<i>(U)SIM Java card TM Platform Protection Profile</i>	29
3.3.1.1	Basic TOE	30
3.3.2	<i>Java Card System Protection Profile - Open Configuration</i>	31
3.3.2.1	CONFIDENTIALITY	31
3.3.2.2	INTEGRITY	32
3.3.2.3	IDENTITY USURPATION	32
3.3.2.4	UNAUTHORIZED EXECUTION	33
3.3.2.5	DENIAL OF SERVICE	33
3.3.2.6	CARD MANAGEMENT	34
3.3.2.7	SERVICES	34
3.3.3	<i>(U)SIM</i>	34
3.4	ORGANISATIONAL SECURITY POLICIES	34
3.4.1	<i>(U)SIM Java card TM Platform Protection Profile</i>	34

	Reference	D1226479	Release	1.3p
			<small>(Printed copy not controlled: verify the version before using)</small>	
	Classification level	Public	Pages	177

3.4.1.1	Basic TOE.....	35
3.4.1.2	Secure places	38
3.4.2	<i>Java Card System Protection Profile - Open Configuration.....</i>	<i>38</i>
3.4.3	<i>(U)SIM</i>	<i>38</i>
3.5	ASSUMPTIONS	40
3.5.1	<i>(U)SIM Java card TM Platform Protection Profile</i>	<i>40</i>
3.5.1.1	Actors	40
3.5.2	<i>Java Card System Protection Profile - Open Configuration.....</i>	<i>41</i>
4	SECURITY OBJECTIVES	42
4.1	SECURITY OBJECTIVES FOR THE TOE	42
4.1.1	<i>(U)SIM Java card TM Platform Protection Profile</i>	<i>42</i>
4.1.1.1	Basic TOE.....	42
4.1.2	<i>Java Card System Protection Profile - Open Configuration.....</i>	<i>44</i>
4.1.2.1	IDENTIFICATION.....	44
4.1.2.2	EXECUTION.....	44
4.1.2.3	SERVICES	45
4.1.2.4	OBJECT DELETION	46
4.1.2.5	APPLET MANAGEMENT.....	46
4.1.2.6	SCP.....	46
4.1.3	<i>(U)SIM</i>	<i>47</i>
4.2	SECURITY OBJECTIVES FOR THE OPERATIONAL ENVIRONMENT	47
4.2.1	<i>(U)SIM Java card TM Platform Protection Profile</i>	<i>47</i>
4.2.1.1	Basic TOE.....	48
4.2.2	<i>Java Card System Protection Profile - Open Configuration.....</i>	<i>51</i>
4.2.3	<i>(U)SIM</i>	<i>51</i>
4.3	SECURITY OBJECTIVES RATIONALE.....	51
4.3.1	<i>Threats</i>	<i>51</i>
4.3.1.1	<i>(U)SIM Java card TM Platform Protection Profile</i>	<i>51</i>
4.3.1.2	<i>Java Card System Protection Profile - Open Configuration</i>	<i>53</i>
4.3.1.3	<i>(U)SIM.....</i>	<i>59</i>
4.3.2	<i>Organisational Security Policies</i>	<i>59</i>
4.3.2.1	<i>(U)SIM Java card TM Platform Protection Profile</i>	<i>59</i>
4.3.2.2	<i>Java Card System Protection Profile - Open Configuration</i>	<i>60</i>
4.3.2.3	<i>(U)SIM.....</i>	<i>60</i>
4.3.3	<i>Assumptions</i>	<i>61</i>
4.3.3.1	<i>(U)SIM Java card TM Platform Protection Profile</i>	<i>61</i>
4.3.3.2	<i>Java Card System Protection Profile - Open Configuration</i>	<i>61</i>
4.3.4	<i>Security Objectives for the TOE.....</i>	<i>61</i>
4.3.4.1	<i>(U)SIM Java card TM Platform Protection Profile.....</i>	<i>61</i>
4.3.5	<i>SPD and Security Objectives</i>	<i>61</i>
5	EXTENDED REQUIREMENTS	73
5.1	EXTENDED FAMILIES.....	73
5.1.1	<i>Extended family FCS_RND - Random Number Generation.....</i>	<i>73</i>
5.1.1.1	Description.....	73
5.1.1.2	Extended components.....	73
5.1.1.3	Rationale.....	73
6	SECURITY FUNCTIONAL REQUIREMENTS.....	74
6.1	SECURITY FUNCTIONAL REQUIREMENTS	74
6.1.1	<i>(U)SIM Java card TM Platform Protection Profile</i>	<i>74</i>
6.1.1.1	Basic TOE.....	74
6.1.2	<i>Java Card System Protection Profile - Open Configuration.....</i>	<i>86</i>

	Reference	D1226479	Release	1.3p <small>(Printed copy not controlled: verify the version before using)</small>
	Classification level	Public	Pages	177

6.1.2.1	CoreG_LC Security Functional Requirements.....	93
6.1.2.2	InstG Security Functional Requirements	112
6.1.2.3	ADELG Security Functional Requirements	115
6.1.2.4	RMIG Security Functional Requirements	119
6.1.2.5	ODELG Security Functional Requirements.....	124
6.1.2.6	CarG Security Functional Requirements	125
6.1.2.7	SCP.....	129
6.1.3	<i>(U)SIM</i>	<i>131</i>
6.1.3.1	Crypto JCAPI	131
6.1.3.2	SecureAPI	131
6.1.3.3	GemActivate.....	132
6.1.3.4	EMVUtilAPI	133
6.2	SECURITY ASSURANCE REQUIREMENTS.....	133
6.3	SECURITY REQUIREMENTS RATIONALE	133
6.3.1	<i>Objectives</i>	<i>133</i>
6.3.1.1	Security Objectives for the TOE	133
6.3.2	<i>Rationale tables of Security Objectives and SFRs.....</i>	<i>140</i>
6.3.3	<i>Dependencies</i>	<i>151</i>
6.3.3.1	SFRs dependencies	151
6.3.3.2	SARs dependencies.....	158
6.3.4	<i>Rationale for the Security Assurance Requirements</i>	<i>160</i>
6.3.5	<i>ALC_DVS.2 Sufficiency of security measures.....</i>	<i>160</i>
6.3.6	<i>AVA_VAN.5 Advanced methodical vulnerability analysis</i>	<i>160</i>
7	TOE SUMMARY SPECIFICATION.....	161
7.1	TOE SUMMARY SPECIFICATION.....	161
7.1.1	<i>Basic TOE.....</i>	<i>161</i>
7.1.1.1	GP	161
7.1.1.2	JCS.....	163
7.1.1.3	SecureAPI	167
7.1.1.4	EMVUtil_API	167
7.1.1.5	GemActivate.....	167
7.1.1.6	OS.....	168
7.1.1.7	IC.....	168
7.2	SFRs AND TSS.....	170
7.2.1	<i>SFRs and TSS - Rationale</i>	<i>170</i>
7.2.2	<i>Association tables of SFRs and TSS</i>	<i>170</i>
8	NOTICE	171
9	REFERENCES, GLOSSARY AND ABBREVIATIONS	172
9.1	EXTERNAL REFERENCES.....	172
9.2	INTERNAL REFERENCES	175
9.3	ABBREVIATIONS.....	176
9.4	GLOSSARY	177



	Reference D1226479	Release 1.3p <small>(Printed copy not controlled: verify the version before using)</small>
	Classification level Public	Pages 177

Table of Tables

Table 1 ST References	7
Table 2 TOE References.....	8
Table 3 TOE components	11
Table 4 Refinement of SFR of PP(USIM).....	21
Table 5 Refinement of SFR of PP JCS.....	24
Table 6 Compatibility study	24
Table 7 List of SFR added in ST versus PP.....	25
Table 8 Threats and Security Objectives - Coverage	64
Table 9 Security Objectives and Threats - Coverage	67
Table 10 OSPs and Security Objectives - Coverage	68
Table 11 Security Objectives and OSPs - Coverage	71
Table 12 Assumptions and Security Objectives for the Operational Environment - Coverage.....	71
Table 13 Security Objectives for the Operational Environment and Assumptions - Coverage.....	72
Table 14 Security Objectives and SFRs - Coverage	145
Table 15 SFRs and Security Objectives	150
Table 16 SFRs dependencies	157
Table 17 SARs dependencies.....	159

	Reference	D1226479	Release	1.3p <small>(Printed copy not controlled: verify the version before using)</small>
	Classification level	Public	Pages	177

1.2 TOE Reference

Product and TOE are completely defined by information located in the following table.

Product Name	Orange NFC V2 G1 card
Product Reference	T1019210
Product Version	Release A
TOE name	Orange NFC V2 G1 platform using ST33F1M
TOE Reference	S1105439
TOE Version	Release A

Table 2 TOE References

This product is developed for Orange by Gemalto as a dedicated customization of a generic product named Upteq m-NFC 2.0 platform.

1.3 TOE overview

1.3.1 TOE Type

The product **Orange NFC V2 G1 card** is U)SIM smart card defined to be used mainly in a mobile or a Smartphone, but can be used in any device with an interface conformant to [ISO 7816] specification. It is delivered using 2FF (Plug-In) or 3FF (Mini-UICC) form factor as described in [TS 102 221].

The product **Orange NFC V2 G1 card** (also named m-NFC 2.0 in this document) implements the standard communication protocol (ISO 7816 T=0) and ETSI standard allowing communication between smartcard, mobile and server using OTA.

Moreover, the **Orange NFC V2 G1 card** implements the SWP [TS102613], a new full-duplex, high-speed transport protocol between the smart card and an interface device. Inserted in a NFC-enabled mobile phone, the M-NFC 2.0 smartcard allows communication with a terminal using the standard ISO/IEC 14443 communication protocol.

When loaded on **Orange NFC V2 G1 card**, payment or access control or transport or loyalty applications using SWP and NFC interfaces offer convergence between Mobile communication environment with OTA administration and convenience and security of secure contact less transaction based on smartcard.

The Target of Evaluation (TOE) is the (U)SIM Java Card platform embedded in a (U)SIM card intended to be plugged in a mobile phone or other mobile devices to provide services to an end user. TOE type consistency is given in Conformance rationale in §2.3.

	Reference D1226479	Release 1.3p <small>(Printed copy not controlled: verify the version before using)</small>
	Classification level Public	Pages 177

The Basic TOE is composed of the following bricks:

- A Java Card System according to [PP-JCS] which manages and executes applications called applets. It also provides APIs [JCAPI] to develop applets on top of it, in accordance with Java Card™ specifications,
- GlobalPlatform (GP) packages, which provides a common and widely used interface to communicate with a smart card and manage applications in a secure way, in accordance with [GP] specifications,
- Platform APIs, which provides ways to specifically interact with (U)SIM applications, according to [TS131.130] specifications,
- Telecom environment including network authentication applications (not evaluated) and Telecom communication protocol.
- GemActivate application to activate services in Post-Issuance (loaded in Pre-Issuance) under issuer and Gemalto administration.

The TOE configuration is defined using [PPUSIM] Basic Configuration protection profile, addressing products without the Smart Card Web Server (SCWS) functionality.

1.3.2 TOE usage



Figure 1: Orange NFC V2 G1 card to be inserted in a mobile

The USIM defined in the [3GPP] standards as the Universal Subscriber Identity Module is an evolution of the SIM developed to ensure compliance within UMTS networks. A Subscriber Identity Module (SIM) is a removable module to plug within GSM mobile equipment that contains the International Mobile Subscriber Identity (IMSI) which unambiguously identifies a subscriber. It also stores other subscriber-related information or applications such as SIM Toolkit, and other application (as an E-sign application). In the rest of the document, the term of (U)SIM is used to refer to SIM or USIM as there are considered in the same way regarding security.

The primary services of the (U)SIM (when it is plugged in handset) are the user authentication by PIN capture and the SIM authentication on the MNO network, giving access to MNO services through the mobile. It also stores other subscriber-related information or applications such as SIM Toolkit applications as specified in [TS102.223] and [TS131.111].

	Reference D1226479	Release 1.3p <small>(Printed copy not controlled: verify the version before using)</small>
	Classification level Public	Pages 177

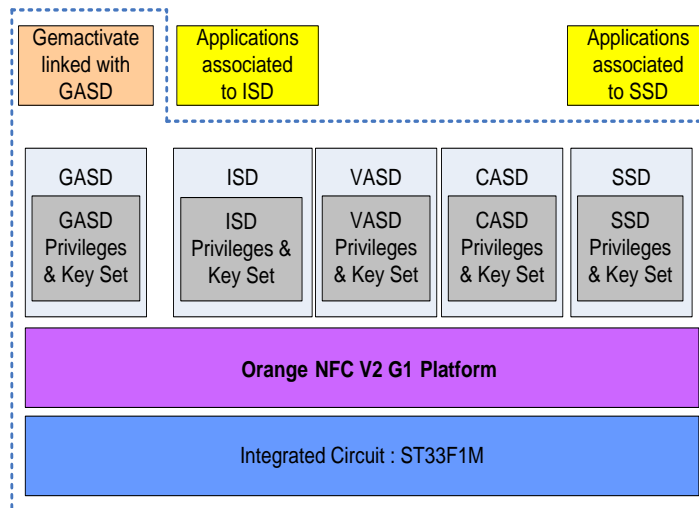

Figure 3: TOE Logical Boundaries

[GP] defines several types of security domains used for domain and application management:

- Issuer Security Domain (ISD),
- Supplementary Security Domain (SSD),
- Controlling Authority Security Domain (CASD),

and [PP-USIM] provides also

Verification Authority Security Domain (VASD).

Gemalto provides platform service activation by OTA using GP security mechanisms associated to GemActivate Security Domain (GASD).

1.3.4 TOE Description

The TOE contains the following components:

Component	Reference/Version	Supplier
ORANGE NFC V2 G1 Platform	S1105439 / Release A	Gemalto
Micro-controller ST33F1M and part of its dedicated software (DS)	Rev E	STMicroelectronics

Table 3 TOE components

The IC (Micro-controller ST33F1M) included in the TOE is compliant with the [PP-BSI-0035]. It includes a crypto library and a Flash loader used for software loading but inactivated for end user usage.

	Reference D1226479	Release 1.3p <small>(Printed copy not controlled: verify the version before using)</small>
	Classification level Public	Pages 177

Note: GemActivate application is associated by default with ISD. GASD is optional and created only on MNO decision. In such case, GemActivate application can be extradited on GASD to use dedicated SCP80 secure channel. For ETSI secure scripting according to GP UICC config, by default ISD SCP80 is used, otherwise GASD or ascendant SD of GASD (e.g ISD) SCP80 is used. In both cases, GemActivate application performs applicative checks prior any required operation.

Note: The Authorized Management privilege is only supported for ISD as excluded in [PPUSIM].

The TOE includes the Telecom Environment with Network Authentication Application, Over The Air and BIP communication, File System management, and Toolkit services.

The TOE supplies EMVUTIL API and secure API in native language to provide enhanced security to applets.

The following figure describes the major items included in the TOE.

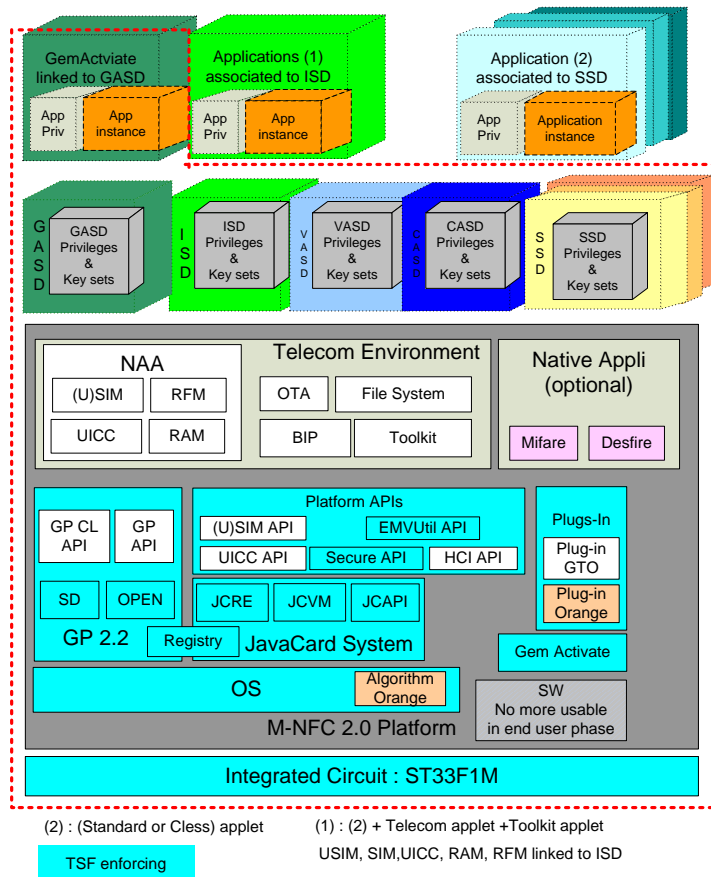



Figure 4: Major TOE Items and TOE scope

1.3.5 TOE Life Cycle

Product life cycle is described in the following picture using [PP-USIM] description refined with Gemalto specific environment due to embedded software loading in flash in phase 6.

	Reference	D1226479	Release	1.3p (Printed copy not controlled: verify the version before using)
	Classification level	Public	Pages	177

The (U)SIM platform life cycle is composed of four stages (as defined in PP (U)SIM figure 3):

- Development (embedded software and IC separately),
- Storage, pre-personalization and test,
- Loading, Personalization and test,
- Final usage.

Refined life cycle based on [PP-BSI-0035] with Gemalto product constraints is described in the following figure.

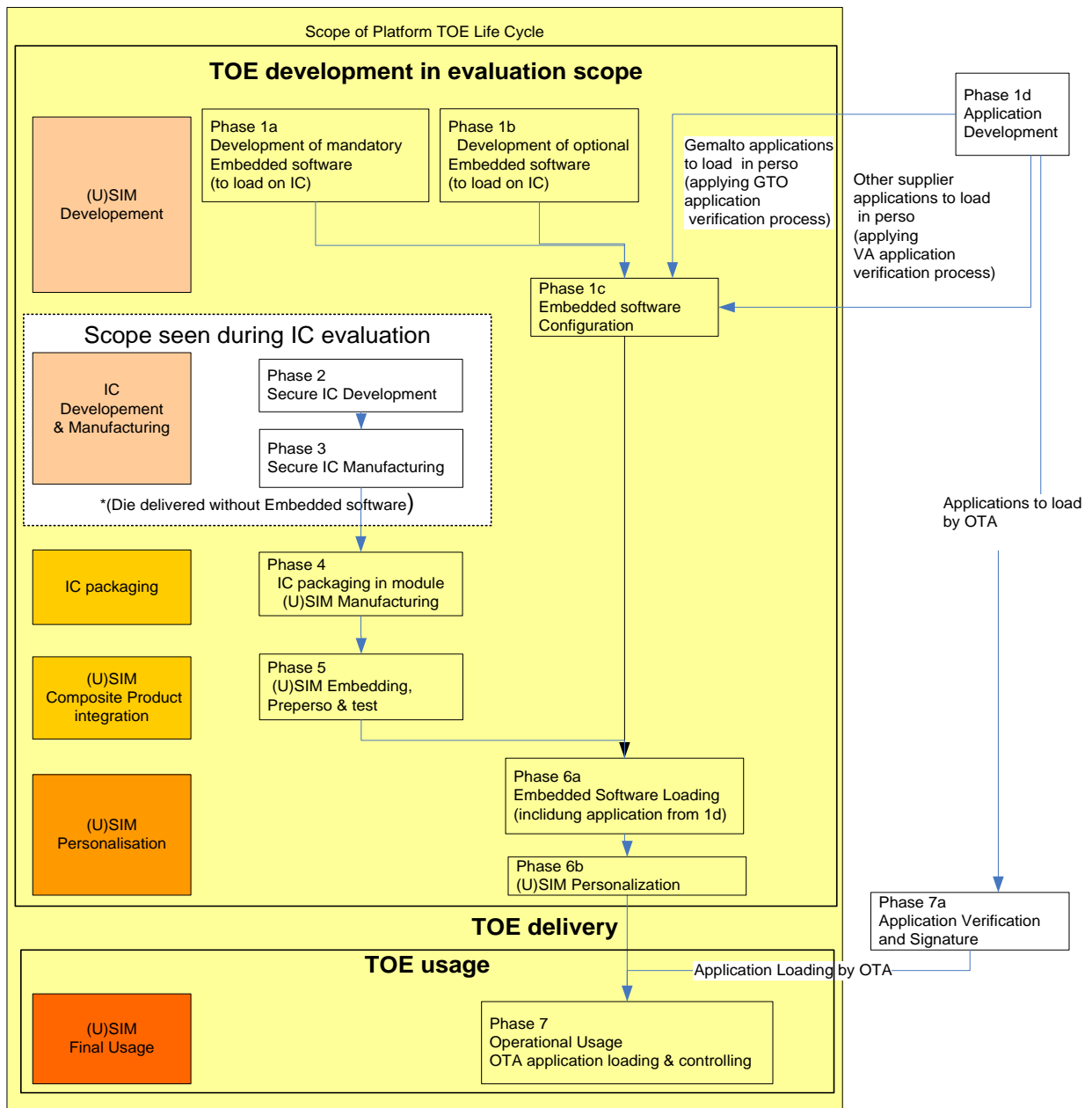



Figure 5: Refined TOE Life Cycle

The following phases corresponding to the one previously described are:

	Reference	D1226479	Release	1.3p <small>(Printed copy not controlled: verify the version before using)</small>
	Classification level	Public	Pages	177

1.3.6.1 TOE Development Environment & Roles

The TOE described in this ST is developed in different places under the control of a defined administrator as indicated below:

Phase	Administrator and Location
IC design and Dedicated Software development	STMicroelectronics Sites are defined in [ST/IC]
Embedded software Development	Gemalto (Meudon, La Ciotat, Singapore)
Embedded software Configuration	Gemalto (Gemenos)

1.3.6.2 TOE Manufacturing Environment

The TOE described in this ST is produced in different places under the control of a defined administrator as indicated below:

Phase	Administrator and Location
IC manufacturing and Testing	STMicroelectronics Sites are defined in [ST/IC]
IC packaging	Gemalto (Pont Audemer)
Composite Product integration	Gemalto (Pont Audemer)

1.3.6.3 TOE Personalization Environment

The TOE described in this ST is personalized in different places under the control of a defined administrator as indicated below:

Phase	Administrator and Location
Personalization	Gemalto (Pont Audemer)
Delivery to Final user (MNO)	From Personalization site to MNO site

1.3.6.4 TOE User Environment

Smart Cards are used in a wide range of applications to assure authorized conditional access. This specific product is to be used on terminals such as GSM and UMTS handsets or smart card readers. The end-user environment therefore covers an unprotected environment, thus making it difficult to avoid any abuse of the TOE. The product is prepared accordingly to mitigate such attacks in this environment.

	Reference D1226479	Release 1.3p <small>(Printed copy not controlled: verify the version before using)</small>
	Classification level Public	Pages 177

Some assumptions (A.KEY-ESCROW, A.PERSONALIZER, and A.PRODUCTION) are replaced by OSP due to change of life cycle between security target and protection profile.

There are extra OSP (OSP.RNG, OSP.JCAPI-Services, OSP.SecureAPI, OSP.EMVUtilAPI) to provide additional services to applications. The extra OSP (OSP.TRUSTED-APPS-DEVELOPER, OSP.TRUSTED-APPS-PRE-ISSUANCE LOADING) are provided to manage pre-issuance and the OSP (OSP.SERVICE AUDIT, OSP.ACTIVATION-KEY-ESCROW) to manage service activation by OTA. Such extension has no impact on PP coverage.

The security objectives statement consistency is assumed because TOE objectives and objectives for environment are aligned between the ST and the PP.

There are extra TOE objectives (O.RND, O.JCAPI-Services, O.SecureAPI, O.REMOTE_SERVICE_ACTIVATION, O.REMOTE_SERVICE_AUDIT, O.EMVUtilAPI) to provide additional services to applications. Such extension has no impact on PP coverage.

Moreover objectives for environment in [PP-JCS] become objectives for the TOE in ST due to inclusion of IC and OS in the ST scope. It is the case for OE.SCP.IC, OE.SCP.RECOVERY, and OE.SCP.SUPPORT becoming respectively O.SCP.IC, O.SCP.RECOVERY, and O.SCP.SUPPORT.

OE.TRUSTED-APPS-DEVELOPER and OE.TRUSTED-APPS-PRE-ISSUANCE LOADING OE.ACTIVATION-KEY-ESCROW are added to manage pre-issuance loading and service activation covering the associated organizational security policies.

The list of SFRs used in the security target includes all the SFR described in the PP (U)SIM even then from implicit inclusion of PP JCS. The following table explains refinements performed between PP (U)SIM and ST.

Note: Items from PP(U)SIM are listed here.

	Reference	D1226479	Release	1.3p <small>(Printed copy not controlled: verify the version before using)</small>
	Classification level	Public	Pages	177

Functional requirement	Refined in [PP-JCS]	Refined in this ST
FDP_ACC.2/FIREWALL	PP	NO
FDP_ACF.1/FIREWALL	PP	NO
FDP_IFC.1/JCVM	PP	NO
FDP_IFF.1/JCVM	PP	ST
FDP_RIP.1/OBJECTS	PP	NO
FMT_MSA.1/JCRE	PP	NO
FMT_MSA.1/JCVM	PP	NO
FMT_MSA.2/FIREWALL_JCVM	PP	NO
FMT_MSA.3/FIREWALL	PP	NO
FMT_MSA.3/JCVM	PP	NO
FMT_SMF.1	PP	NO
FMT_SMR.1	PP	NO
FCS_CKM.1	PP	ST
FCS_CKM.2	PP	ST
FCS_CKM.3	PP	ST
FCS_CKM.4	PP	ST
FCS_COP.1	PP	ST
FDP_RIP.1/ABORT	PP	NO
FDP_RIP.1/APDU	PP	NO
FDP_RIP.1/bArray	PP	NO
FDP_RIP.1/KEYS	PP	NO
FDP_RIP.1/TRANSIENT	PP	NO
FDP_ROL.1/FIREWALL	PP	NO
FAU_ARP.1	PP	NO
FDP_SDI.2	PP	NO
FPR_UNO.1	PP	ST
FPT_FLS.1	PP	NO
FPT_TDC.1	PP	NO
FIA_ATD.1/AID	PP	NO
FIA_UID.2/AID	PP	NO
FIA_USB.1/AID	PP	ST
FMT_MTD.1/JCRE	PP	NO
FMT_MTD.3/JCRE	PP	NO



Reference

D1226479

Release

1.3p

(Printed copy not controlled: verify the version before using)

Classification level

Public

Pages

177

Functional requirement	Refined in [PP-JCS]	Refined in this ST
FDP_ITC.2/Installer	PP	NO
FMT_SMR.1/Installer	PP	NO
FPT_FLS.1/Installer	PP	NO
FPT_RCV.3/Installer	PP	ST
FDP_ACC.2/ADEL	PP	NO
FDP_ACF.1/ADEL	PP	NO
FDP_RIP.1/ADEL	PP	NO
FMT_MSA.1/ADEL	PP	NO
FMT_MSA.3/ADEL	PP	NO
FMT_SMF.1/ADEL	PP	NO
FMT_SMR.1/ADEL	PP	NO
FPT_FLS.1/ADEL	PP	NO
FDP_ACC.2/JCRMI	PP	NO
FDP_ACF.1/JCRMI	PP	NO
FDP_IFC.1/JCRMI	PP	NO
FDP_IFF.1/JCRMI	PP	NO
FMT_MSA.1/EXPORT	PP	NO
FMT_MSA.1/REM_REFS	PP	NO
FMT_MSA.3/JCRMI	PP	NO
FMT_REV.1/JCRMI	PP	NO
FMT_SMF.1/JCRMI	PP	NO
FMT_SMR.1/JCRMI	PP	NO
FDP_RIP.1/ODEL	PP	NO
FPT_FLS.1/ODEL	PP	NO
FCO_NRO.2/CM	PP	NO
FDP_IFC.2/CM	PP	NO
FDP_IFF.1/CM	PP	ST
FDP_UIT.1/CM	PP	ST
FIA_UID.1/CM	PP	NO
FMT_MSA.1/CM	PP	ST
FMT_MSA.3/CM	PP	ST
FMT_SMF.1/CM	PP	ST
FMT_SMR.1/CM	PP	ST

	Reference D1226479	Release 1.3p <small>(Printed copy not controlled: verify the version before using)</small>
	Classification level Public	Pages 177

Functional requirement	Refined in [PP-JCS]	Refined in this ST
FTP_ITC.1/CM	PP	NO

Table 5 Refinement of SFR of PP JCS

The functional requirements are both refined in the claimed PP and in this ST. This section demonstrates the compatibility of the refinements done in both documents.

No: No refinement in PP or ST

(PP): Refinement has been made in the PP.

(ST): Additional refinement has been made in the ST.

NA: the functional requirement requires no refinement.

	Addition in ST
Assets	YES
Threats	YES
Assumptions	NO
Organizational Security Policies	YES
Security objectives for the TOE	YES
Security objectives for the operational environment	YES
Security functional requirements	YES
Security assurance requirements	NO
Security Requirements for the IT Environment	NO

Table 6 Compatibility study

List of SFR added in ST versus PP (U) SIM is given in the next table.

	Reference	D1226479	Release	1.3p <small>(Printed copy not controlled: verify the version before using)</small>
	Classification level	Public	Pages	177

Functional requirement	Refined in this ST
FPT_RCV.3 /OS	YES
FPT_RCV.4 /OS	YES
FCS_COP.1/SHA2	YES
FCS_COP.1/CRC	YES
FCS_RND.1	YES
FPT_FLS.1/SecureAPI	YES
FPT_ITT.1/SecureAPI	YES
FPT_UNO.1/SecureAPI	YES
FMT_SMR.1/GemActivate	YES
FMT_SMF.1/GemActivate	YES
FMT_MOF.1/GemActivate	YES
FMT_MSA.1/GemActivate	YES
FMT_MTD.1/GemActivate	YES
FPT_ITT.1/EMVUtil_API	YES
FDP_SDI.1/EMVUtil_API	YES

Table 7 List of SFR added in ST versus PP

All PP requirements have been shown to be satisfied in the extended set of requirements whose completeness, consistency and soundness has been argued in the rationale sections of the present document.

The SARs statements consistency is assumed because the same assurance package is used.

	Reference	D1226479	Release	1.3p <small>(Printed copy not controlled: verify the version before using)</small>
	Classification level	Public	Pages	177

3 Security problem definition

3.1 Assets

3.1.1 (U)SIM Java card TM Platform Protection Profile

Assets are security-relevant elements to be directly protected by the TOE. Confidentiality of assets is always intended with respect to un-trusted people or software, as various parties are involved during the first stages; details are given in threats hereafter.

The assets introduced in this PP are of two kinds: specialisation of a PPJCS asset (all the threats identified in JCS apply, plus some new ones) or new asset (new threats apply).

They are divided first following the two configurations and then in two groups. The first one contains the data created by and for the user (User data) and the second one includes the data created by and for the TOE (TSF data). For each asset it is specified the kind of risks they run.

Note that assets listed in the underlying Java Card System Protection Profile are included in this Protection Profile. For a detailed description refer to [PP-JCS].

3.1.1.1 Basic TOE

This section describes the assets for the Basic TOE, applicable to PP09ya.

User Data

The following assets specialize the asset D.APP_KEYS from [PP-JCS].

D.APSD_KEYS

Application Provider Security Domains cryptographic keys needed to establish secure channels with the AP. These keys can be used to load and install applications on the card is the Security Domain has the appropriate privileges.

To be protected from unauthorized disclosure and modification.

D.CASD_KEYS

Controlling Authority Security Domains cryptographic keys needed to establish secure channels with the CA and to decrypt confidential content for APSDs.

To be protected from unauthorized disclosure and modification.

D.ISD_KEYS

Issuer Security Domain cryptographic keys needed to perform card management operations on the card.

To be protected from unauthorized disclosure and modification.

	Reference D1226479	Release 1.3p <small>(Printed copy not controlled: verify the version before using)</small>
	Classification level Public	Pages 177

To be protected from unauthorized modification.

D.APP_C_DATA

Confidential sensitive data of the applications, like the data contained in an object, a static field of a package, a local variable of the currently executed method, or a position of the operand stack.

To be protected from unauthorized disclosure.

D.APP_I_DATA

Integrity sensitive data of the applications, like the data contained in an object, a static field of a package, a local variable of the currently executed method, or a position of the operand stack.

To be protected from unauthorized modification.

D.APP_KEYS

Cryptographic keys owned by the applets.

To be protected from unauthorized disclosure and modification.

D.PIN

Any end-user's PIN.

To be protected from unauthorized disclosure and modification.

3.1.2.2 TSF data

D.API_DATA

Private data of the API, like the contents of its private fields.

To be protected from unauthorized disclosure and modification.

D.CRYPTO

Cryptographic data used in runtime cryptographic computations, like a seed used to generate a key.

To be protected from unauthorized disclosure and modification.

D.JCS_CODE

The code of the Java Card System.

To be protected from unauthorized disclosure and modification.

D.JCS_DATA

The internal runtime data areas necessary for the execution of the Java Card VM, such as, for instance, the frame stack, the program counter, the class of an object, the length allocated for an array, any pointer used to chain data-structures.

To be protected from unauthorized disclosure or modification.

	Reference D1226479	Release 1.3p <small>(Printed copy not controlled: verify the version before using)</small>
	Classification level Public	Pages 177

D.SEC_DATA

The runtime security data of the Java Card RE, like, for instance, the AIDs used to identify the installed applets, the currently selected applet, the current context of execution and the owner of each object.

To be protected from unauthorized disclosure and modification.

3.1.3 (U)SIM

D.OPTIONAL_PF_SERVICE

Platform services can be configured by addition of optional services as:

new cryptographic algorithm service available through API

new network authentication algorithm available through API

3.2 Users / Subjects

3.2.1 (U)SIM Java card TM Platform Protection Profile

Subjects are active components of the TOE that (essentially) act on the behalf of users. Users of the TOE include people or institutions (like the AP, the MNO and the VA), hardware (like the CAD where the card is inserted) and software components (like the application packages installed on the card).

In this Protection Profile, relevant subjects are those listed in [PP-JCS] plus the following ones:

3.2.1.1 Basic TOE

This section describes the subjects for the Basic TOE, applicable to [PPUSIM]

S.SD

A GlobalPlatform Security Domain representing on the card an off-card entity. This entity can be the Issuer, an Application Provider, the Controlling Authority or the Validation Authority.

3.2.2 Java Card System Protection Profile - Open Configuration

The subjects associated to JCS are defined in chapter introduction related to JCS security functional requirements.

3.3 Threats

3.3.1 (U)SIM Java card TM Platform Protection Profile

This section introduces the threats to the assets against which specific protection within the TOE or its environment is required. Several groups of threats are distinguished according to the means used in the attack. The classification is also inspired by the components of the TOE that are supposed to counter each threat.

	Reference D1226479	Release 1.3p <small>(Printed copy not controlled: verify the version before using)</small>
	Classification level Public	Pages 177

The threats listed below focus only on the (U)SIM Platform. Some of them refine those already present in [PP-JCS].

All the Java Card System threats of [PP-JCS] are also relevant to this Protection Profile.

3.3.1.1 Basic TOE

This section describes threats for the Basic TOE, applicable to [PPUSIM].

T.PHYSICAL

The attacker discloses or modifies the design of the TOE, its sensitive data or application code by physical (opposed to logical) tampering means. This threat includes IC failure analysis, electrical probing, unexpected tearing, and DP analysis. That also includes the modification of the runtime execution of Java Card System, GlobalPlatform or SCP or SCWS (for the SCWS TOE) software through alteration of the intended execution order of (set of) instructions through physical tampering techniques.

This threatens all the identified assets. The attacker discloses or modifies the design of the TOE, its sensitive data or application code by physical (opposed to logical) tampering means. This threat includes IC failure analysis, electrical probing, unexpected tearing, and DPA. That also includes the modification of the runtime execution of Java Card System or SCP software through alteration of the intended execution order of (set of) instructions through physical tampering techniques.

This threatens all the identified assets.

This threat refers to the point (7) of the security aspect #.SCP, and all aspects related to confidentiality and integrity of code and data.

T.INTEG-USER-DATA

The attacker through a malicious applet loaded on the card modifies application data, application keys or authentication data.

Directly threatened asset(s): **D.(U)SIM_DATA** **D.ISD_KEYS**, **D.VASD_KEYS**, **D.APSD_KEYS** and **D.CASD_KEYS**.

T.COM_EXPLOIT

An attacker remotely exploits the communication channel (USB, ISO-7816, NFC, BIP or SMS) established between the mobile phone and the (U)SIM card in order to modify or disclose confidential data.

All assets are threatened.

T.UNAUTHORIZED_CARD_MNGT

The attacker performs unauthorized card management operations (for instance impersonates one of the actors represented on the card) in order to take benefit of the privileges or services granted to this actor on the card such as fraudulent:

- load of a package file
- installation of a package file
- extradition of a package file or an applet
- personalization of an applet or a Security Domain

	Reference D1226479	Release 1.3p <small>(Printed copy not controlled: verify the version before using)</small>
	Classification level Public	Pages 177

deletion of a package file or an applet

privileges update of an applet or a Security Domain

Directly threatened asset(s): **D.ISD_KEYS**, **D.CASD_KEYS**, **D.APSD_KEYS**, **D.APP_C_DATA** (from [PP-JCS]), **D.APP_I_DATA** (from [PP-JCS]), **D.APP_CODE** (from [PP-JCS]) and **D.CARD_MNGT_DATA**.

T.LIFE_CYCLE

An attacker accesses to an application outside of its expected availability range thus violating irreversible life cycle phases of the application (for instance, an attacker re-personalizes the application).

Directly threatened asset(s): **D.APP_I_DATA** (from [PP-JCS]), **D.APP_C_DATA** (from [PP-JCS]), and **D.CARD_MNGT_DATA**.

T.UNAUTHORIZED_ACCESS

By using the shareable object mechanism on which relies the communication between two applets, the attacker uses an applet on card to get access or to modify data from another applet that he should not have access to.

All assets are threatened.

3.3.2 Java Card System Protection Profile - Open Configuration

This section introduces the threats to the assets against which specific protection within the TOE or its environment is required. Several groups of threats are distinguished according to the configuration chosen for the TOE and the means used in the attack. The classification is also inspired by the components of the TOE that are supposed to counter each threat.

3.3.2.1 CONFIDENTIALITY

T.CONFID-APPLI-DATA

The attacker executes an application to disclose data belonging to another application. See #.CONFID-APPLI-DATA for details.

Directly threatened asset(s): D.APP_C_DATA, D.PIN and D.APP_KEYS.

T.CONFID-JCS-CODE

The attacker executes an application to disclose the Java Card System code. See #.CONFID-JCS-CODE for details.

Directly threatened asset(s): D.JCS_CODE.

T.CONFID-JCS-DATA

The attacker executes an application to disclose data belonging to the Java Card System. See #.CONFID-JCS-DATA for details.

Directly threatened asset(s): D.API_DATA, D.SEC_DATA, D.JCS_DATA and D.CRYPTO.

	Reference D1226479	Release 1.3p <small>(Printed copy not controlled: verify the version before using)</small>
	Classification level Public	Pages 177

3.3.2.2 INTEGRITY

T.INTEG-APPLI-CODE

The attacker executes an application to alter (part of) its own code or another application's code. See #.INTEG-APPLI-CODE for details.

Directly threatened asset(s): D.APP_CODE.

T.INTEG-APPLI-CODE.LOAD

The attacker modifies (part of) its own or another application code when an application package is transmitted to the card for installation. See #.INTEG-APPLI-CODE for details.

Directly threatened asset(s): D.APP_CODE.

T.INTEG-APPLI-DATA

The attacker executes an application to alter (part of) another application's data. See #.INTEG-APPLI-DATA for details.

Directly threatened asset(s): D.APP_I_DATA, D.PIN and D.APP_KEYS.

T.INTEG-APPLI-DATA.LOAD

The attacker modifies (part of) the initialization data contained in an application package when the package is transmitted to the card for installation. See #.INTEG-APPLI-DATA for details.

Directly threatened asset(s): D.APP_I_DATA and D_APP_KEY.

T.INTEG-JCS-CODE

The attacker executes an application to alter (part of) the Java Card System code. See #.INTEG-JCS-CODE for details.

Directly threatened asset(s): D.JCS_CODE.

T.INTEG-JCS-DATA

The attacker executes an application to alter (part of) Java Card System or API data. See #.INTEG-JCS-DATA for details.

Directly threatened asset(s): D.API_DATA, D.SEC_DATA, D.JCS_DATA and D.CRYPTO.

Other attacks are in general related to one of the above, and aimed at disclosing or modifying on-card information. Nevertheless, they vary greatly on the employed means and threatened assets, and are thus covered by quite different objectives in the sequel. That is why a more detailed list is given hereafter.

3.3.2.3 IDENTITY USURPATION

T.SID.1

An applet impersonates another application, or even the Java Card RE, in order to gain illegal access to some resources of the card or with respect to the end user or the terminal. See #.SID for details.

	Reference D1226479	Release 1.3p <small>(Printed copy not controlled: verify the version before using)</small>
	Classification level Public	Pages 177

Directly threatened asset(s): D.SEC_DATA (other assets may be jeopardized should this attack succeed, for instance, if the identity of the JCRE is usurped), D.PIN and D.APP_KEYS.

T.SID.2

The attacker modifies the TOE's attribution of a privileged role (e.g. default applet and currently selected applet), which allows illegal impersonation of this role. See #.SID for further details.

Directly threatened asset(s): D.SEC_DATA (any other asset may be jeopardized should this attack succeed, depending on whose identity was forged).

3.3.2.4 UNAUTHORIZED EXECUTION

T.EXE-CODE.1

An applet performs an unauthorized execution of a method. See #.EXE-JCS-CODE and #.EXE-APPLI-CODE for details.

Directly threatened asset(s): D.APP_CODE.

T.EXE-CODE.2

An applet performs an execution of a method fragment or arbitrary data. See #.EXE-JCS-CODE and #.EXE-APPLI-CODE for details.

Directly threatened asset(s): D.APP_CODE.

T.EXE-CODE-REMOTE

The attacker performs an unauthorized remote execution of a method from the CAD. See #.EXE-APPLI-CODE for details.

Directly threatened asset(s): D.APP_CODE.

Application note:

This threat concerns version 2.2.x of the Java Card RMI, which allow external users (that is, other than on-card applets) to trigger the execution of code belonging to an on-card applet. On the contrary, T.EXE-CODE.1 is restricted to the applets under the TSF.

T.NATIVE

An applet executes a native method to bypass a TOE Security Function such as the firewall. See #.NATIVE for details.

Directly threatened asset(s): D.JCS_DATA.

3.3.2.5 DENIAL OF SERVICE

T.RESOURCES

An attacker prevents correct operation of the Java Card System through consumption of some resources of the card: RAM or NVRAM. See #.RESOURCES for details.

Directly threatened asset(s): D.JCS_DATA.

	Reference	D1226479	Release	1.3p <small>(Printed copy not controlled: verify the version before using)</small>
	Classification level	Public	Pages	177

3.3.2.6 CARD MANAGEMENT

T.DELETION

The attacker deletes an applet or a package already in use on the card, or uses the deletion functions to pave the way for further attacks (putting the TOE in an insecure state). See #.DELETION for details).

Directly threatened asset(s): D.SEC_DATA and D.APP_CODE.

Application note:

Due to Protection Profile and ST definition, T.DELETION replaces A.DELETION as O.CARD_MANAGEMENT replaces OE.CARD_MANAGEMENT.

T.INSTALL

The attacker fraudulently installs post-issuance of an applet on the card. This concerns either the installation of an unverified applet or an attempt to induce a malfunction in the TOE through the installation process. See #.INSTALL for details.

Directly threatened asset(s): D.SEC_DATA (any other asset may be jeopardized should this attack succeed, depending on the virulence of the installed application).

3.3.2.7 SERVICES

T.OBJ-DELETION

The attacker keeps a reference to a garbage collected object in order to force the TOE to execute an unavailable method, to make it to crash, or to gain access to a memory containing data that is now being used by another application. See #.OBJ-DELETION for further details.

Directly threatened asset(s): D.APP_C_DATA, D.APP_I_DATA and D.APP_KEYS.

3.3.3 (U)SIM

T.UNAUTHORIZED_ACCESS_TO_SERVICE

An attacker may gain direct access to an optional platform service without authorization by bypassing access control to service activation.

3.4 Organisational Security Policies

3.4.1 (U)SIM Java card TM Platform Protection Profile

This section describes the organizational security policies to be enforced with respect to the TOE environment. Rules to which both the TOE and its human environment shall comply when addressing security needs related to (U)SIM Java Card Platform.

All the OSPs listed in [PP-JCS] are relevant for this Protection Profile.

This Security Target adds the following OSPs:

	Reference D1226479	Release 1.3p <small>(Printed copy not controlled: verify the version before using)</small>
	Classification level Public	Pages 177

OSP.QUOTAS

Security domains are subject to quotas of memory at creation.

3.4.1.2 Secure places

OSP.PRODUCTION

Production and personalization environment has to be secured as the TOE delivery occurs after Phase 6.

Application note:

Such OSP replaces A.PRODUCTION defines in the PP (U)SIM.

OSP.PERSONALIZER

The personalizer under an Operator's Contract is in charge of the TOE personalization process before card issuance. He ensures the security of the keys he loads on the (U)SIM cards:

- Mobile operator keys including OTA keys (telecom keys either generated by the personalizer or by the mobile operator) and delegated management token keys
- Issuer Security Domain keys (ISD keys or Card issuer keys),
- Application Provider Security Domains keys (APSD keys).
- Controlling Authority Security Domain keys (CASD keys)
- Verification Authority Security Domain keys (VASD keys)

Application note:

Such OSP replaces A.PRODUCTION defines in the PP (U)SIM.

OSP.KEY-ESCROW

The key escrow is a trusted actor in charge of the secure storage of the initial AP keys generated by the TOE personalizer during initial personalization. He ensures the security of the keys.

3.4.2 Java Card System Protection Profile - Open Configuration

This section describes the organizational security policies to be enforced with respect to the TOE environment.

OSP.VERIFICATION

This policy shall ensure the consistency between the export files used in the verification and those used for installing the verified file. The policy must also ensure that no modification of the file is performed in between its verification and the signing by the verification authority. See #.VERIFICATION for details.

3.4.3 (U)SIM

This section describes the organizational security policies to be enforced with respect to the TOE (U)SIM environment.

	Reference D1226479	Release 1.3p <small>(Printed copy not controlled: verify the version before using)</small>
	Classification level Public	Pages 177

OSP.SecureAPI

The TOE must contribute to ensure that application can optimize control on its sensitive operations using a dedicated API provided by TOE. TOE will provide services for secure array management and to detect loss of data integrity and inconsistent execution flow and react against tearing or fault induction.

OSP.RNG

This policy shall ensure the entropy of the random numbers provided by the TOE to applet using [JCAPI] is sufficient. Thus attacker is not able to predict or obtain information on generated numbers.

OSP.JCAPI-Services

This policy shall ensure that hashing and checksum security services defined in [JCAPI] provided by the TOE to applet is secure. Thus attacker is not able to predict or obtain information on manipulated data.

OSP.TRUSTED-APPS-DEVELOPER

There are application developers (as Gemalto) considered as trusted by platform issuer and application providers. The confidence in these actors has been obtained by audit of development process and development environment performed by ITSEF during private scheme evaluation or Common Criteria composite evaluation process.

Application note: As a consequence, the development process applied by a trusted developer provides confidence that applications developed by such actors are considered as not aggressive versus the platform and other applications loaded on the platform.

OSP.TRUSTED-APPS-PRE-ISSUANCE LOADING

For Pre-Issuance loading of trusted* applications, the audited process during Platform evaluation must be used.

[* Application notes: An application is considered as trusted if it has been developed or verified by a trusted actor (as Gemalto). An application developed by a third party can be considered as a trusted application only if it has been verified and signed by verification authority. The application and associated signature will be verified by Gemalto prior authorizing loading in pre-issuance.

As a consequence, the loading process applied by a trusted personalizer provides confidence that applications developed by trusted actors are considered as not aggressive versus the platform and other applications loaded on the platform.]

OSP.SERVICE_AUDIT

The MNO and GemActivate administrator (usually Gemalto) can audit optional platform service activation using remote service audit.

OSP.ACTIVATION-KEY-ESCROW

The key escrow is a trusted actor in charge of the secure storage of the activation keys generated and stored outside of TOE and import in TOE by the TOE personalizer during initial personalization. He ensures the security of the keys for remote service activation.

	Reference D1226479	Release 1.3p <small>(Printed copy not controlled: verify the version before using)</small>
	Classification level Public	Pages 177

OSP.EMVUtil_API

The TOE must contribute to ensure that Banking application can optimize control on its sensitive operations using a dedicated API providing management of secure container and counter by TOE.

3.5 Assumptions

3.5.1 (U)SIM Java card TM Platform Protection Profile

The following assumption concerns the product operational environment, after product delivery. It applies to any kind of product, with Basic or SCWS TOE, that is, it holds in the Protection Profiles 09ya and 09yb.

All the assumptions mentioned in the [PP-JCS] Protection Profile are relevant.

This Security Target adds the following assumptions:

3.5.1.1 Actors

A.MOBILE-OPERATOR

The mobile operator is a trusted actor responsible for the mobile network and the associated OTA servers.

The mobile operator as Card issuer cannot get access or change the application data which belongs to the AP.

A.OTA-ADMIN

Administrators of the mobile operator OTA servers are trusted people. They are trained to use and administrate securely those servers. They have the means and the equipments to perform their tasks.

They are aware of the sensitivity of the assets they managed and the responsibilities associated to the administration of OTA servers.

Application note:

OTA servers security guidance document with regular site inspections shall be employed to check the applicability of the rules.

A.APPS-PROVIDER

The AP is a trusted actor that provides standard or secure applications. He is responsible for his security domain keys (APSD keys).

Application note:

An AP generally refers to the entity that issues the application. For instance it can be a financial institution for a payment application such as EMV or a transport operator for a transport application such as Calypso.

A.VERIFICATION-AUTHORITY

The VA is a trusted actor who is able to guarantee and check the digital signature attached to a standard or secure application.

	Reference D1226479	Release 1.3p <small>(Printed copy not controlled: verify the version before using)</small>
	Classification level Public	Pages 177

Application note:

As a consequence, it guarantees the success of the application validation or certification upon loading.

A.CONTROLLING-AUTHORITY

The CA is a trusted actor responsible for securing the APSD keys creation and personalization. He is responsible for his security domain keys (CASD keys).

3.5.2 Java Card System Protection Profile - Open Configuration

This section introduces the assumptions made on the environment of the TOE.

A.APPLET

Applets loaded post-issuance do not contain native methods. The Java Card specification explicitly "does not include support for native methods" ([JCVM222], §3.3) outside the API.

A.VERIFICATION

All the bytecodes are verified at least once, before the loading, before the installation or before the execution, depending on the card capabilities, in order to ensure that each bytecode is valid at execution time.

	Reference	D1226479	Release	1.3p <small>(Printed copy not controlled: verify the version before using)</small>
	Classification level	Public	Pages	177

4 Security Objectives

4.1 Security Objectives for the TOE

4.1.1 (U)SIM Java card TM Platform Protection Profile

All the platform security objectives given in [PP-JCS] are included into this Protection Profile. The security objectives given hereafter are these specifically relevant for the card management and for the SCWS.

4.1.1.1 Basic TOE

This section describes the security objectives for the Basic TOE, applicable to [PPUSIM].

Card Management

O.CARD-MANAGEMENT

The TOE shall provide card management functionalities (loading, installation, extradition, deletion of applications and GP registry updates) in charge of the life cycle of the whole (U)SIM card and installed applications (applets)

The card manager, the application with specific rights responsible for the administration of the smart card, shall control the access to card management functions. It shall also implement the card issuer's policy on card management.

Application note:

The card manager will be tightly connected in practice with the rest of the TOE, which in return shall very likely rely on the card manager for the effective enforcement of some of its security functions.

The mechanism used to ensure authentication of the TOE issuer, that manages the TOE, or of the Service Providers owning a Security Domain with card management privileges is a secure channel. This channel will be used afterwards to protect commands exchanged with the TOE in confidentiality and integrity.

The platform guarantees that only the ISD or the Service Providers owning a Security Domain with the appropriate privilege (Delegated Management) can manage the applications on the card associated with its Security Domain. This is done accordingly with the card issuer's policy on card management.

The actor performing the operation must beforehand authenticate with the Security Domain. In the case of Delegated Management, the card management command will be associated with an electronic signature (GlobalPlatform token) verified by the ISD before execution.

O.DOMAIN-RIGHTS

The Card issuer shall not get access or change personalized AP security domain keys which belong to the AP. Modification of a security domain keyset is restricted to the AP who owns the security domain.

	Reference D1226479	Release 1.3p <small>(Printed copy not controlled: verify the version before using)</small>
	Classification level Public	Pages 177

Application note:

APs have a set of keys that allows them to establish a secure channel between them and the platform. These keys sets are not known by the TOE issuer. The security domain initial keys are changed before any operation on the SD (OE.KEY-CHANGE) through standard PUT KEY procedures (if the initial keys were kept by key escrow) or through one of the SD personalization mechanisms described in Section 4.3.3 of [GP-UICC].

O.APPLI-AUTH

The card manager shall enforce the application security policies established by the card issuer by requiring application authentication during application loading on the card.

Application note:

Each application loaded onto the TOE has been signed by the VA. The VA will guarantee that the security policies established by the card issuer on applications are enforced. This authority is present on the TOE as a Security Domain whose role is to verify each signature at application loading.

The platform provides important extra features about application management and especially loading:

Loaded applications are previously validated by an accredited laboratory for standard applications and certified by an accredited ITSEF for secure applications.

All loaded applications are associated to a DAP signature generated by a VA which is verified at loading by the third party representative present on the platform (Mandated DAP verification).

Communication

O.COMM_AUTH

The TOE shall authenticate the origin of the card management requests that the card receives, and authenticate itself to the remote actor.

O.COMM_INTEGRITY

The TOE shall verify the integrity of the card management requests that the card receives.

O.COMM_CONFIDENTIALITY

The TOE shall be able to process card management requests containing encrypted data.

SCP

O.SCP-SUPPORT

The TOE OS shall support the following functionalities:

- (1) It does not allow the TSFs to be bypassed or altered and does not allow access to other low-level functions than those made available by the packages of the API. That includes the protection of its private data and code (against disclosure or modification) from the Java Card System.
- (2) It provides secure low-level cryptographic processing to the Java Card System, GlobalPlatform.

	Reference D1226479	Release 1.3p <small>(Printed copy not controlled: verify the version before using)</small>
	Classification level Public	Pages 177

- (3) It supports the needs for any update to a single persistent object or class field to be atomic, and possibly a low-level transaction mechanism.
- (4) It allows the Java Card System to store data in "persistent technology memory" or in volatile memory, depending on its needs (for instance, transient objects must not be stored in non-volatile memory). The memory model is structured and allows for low-level control accesses (segmentation fault detection).

4.1.2 Java Card System Protection Profile - Open Configuration

This section defines the security objectives to be achieved by the TOE.

4.1.2.1 IDENTIFICATION

O.SID

The TOE shall uniquely identify every subject (applet, or package) before granting it access to any service.

4.1.2.2 EXECUTION

O.FIREWALL

The TOE shall ensure controlled sharing of data containers owned by applets of different packages or the JCRE and between applets and the TSFs. See #.FIREWALL for details.

O.GLOBAL_ARRAYS_CONFID

The TOE shall ensure that the APDU buffer that is shared by all applications is always cleaned upon applet selection.

The TOE shall ensure that the global byte array used for the invocation of the install method of the selected applet is always cleaned after the return from the install method.

O.GLOBAL_ARRAYS_INTEG

The TOE shall ensure that only the currently selected application may have a write access to the APDU buffer and the global byte array used for the invocation of the install method of the selected applet.

O.NATIVE

The only means that the Java Card VM shall provide for an application to execute native code is the invocation of a method of the Java Card API, or any additional API. See #.NATIVE for details.

O.OPERATE

The TOE must ensure continued correct operation of its security functions. See #.OPERATE for details.

O.REALLOCATION

The TOE shall ensure that the re-allocation of a memory block for the runtime areas of the Java Card VM does not disclose any information that was previously stored in that block.

	Reference D1226479	Release 1.3p <small>(Printed copy not controlled: verify the version before using)</small>
	Classification level Public	Pages 177

O.RESOURCES

The TOE shall control the availability of resources for the applications. See #.RESOURCES for details.

4.1.2.3 SERVICES

O.ALARM

The TOE shall provide appropriate feedback information upon detection of a potential security violation. See #.ALARM for details.

O.CIPHER

The TOE shall provide a means to cipher sensitive data for applications in a secure way. In particular, the TOE must support cryptographic algorithms consistent with cryptographic usage policies and standards. See #.CIPHER for details.

O.KEY-MNGT

The TOE shall provide a means to securely manage cryptographic keys. This concerns the correct generation, distribution, access and destruction of cryptographic keys. See #.KEY-MNGT.

O.PIN-MNGT

The TOE shall provide a means to securely manage PIN objects. See #.PIN-MNGT for details.

Application note:

PIN objects may play key roles in the security architecture of client applications. The way they are stored and managed in the memory of the smart card must be carefully considered, and this applies to the whole object rather than the sole value of the PIN. For instance, the try counter's value is as sensitive as that of the PIN.

O.REMOTE

The TOE shall provide restricted remote access from the CAD to the services implemented by the applets on the card. This particularly concerns the Java Card RMI services introduced in version 2.2.x of the Java Card platform.

O.TRANSACTION

The TOE must provide a means to execute a set of operations atomically. See #.TRANSACTION for details.

O.KEY-MNGT, O.PIN-MNGT, O.TRANSACTION and O.CIPHER are actually provided to applets in the form of Java Card APIs. Vendor-specific libraries are present on the card and available to applets; those may be built on top of the Java Card API or independently. These proprietary libraries will be evaluated together with the TOE.

	Reference D1226479	Release 1.3p <small>(Printed copy not controlled: verify the version before using)</small>
	Classification level Public	Pages 177

4.1.2.4 OBJECT DELETION

O.OBJ-DELETION

The TOE shall ensure the object deletion shall not break references to objects. See #.OBJ-DELETION for further details.

4.1.2.5 APPLETT MANAGEMENT

O.DELETION

The TOE shall ensure that both applet and package deletion perform as expected. See #.DELETION for details.

O.LOAD

The TOE shall ensure that the loading of a package into the card is safe.

Application note:

Usurpation of identity resulting from a malicious installation of an applet on the card may also be the result of perturbing the communication channel linking the CAD and the card. Even if the CAD is placed in a secure environment, the attacker may try to capture, duplicate, permute or modify the packages sent to the card. He may also try to send one of its own applications as if it came from the card issuer. Thus, this objective is intended to ensure the integrity and authenticity of loaded CAP files.

O.INSTALL

The TOE shall ensure that the installation of an applet performs as expected (See #.INSTALL for details).

4.1.2.6 SCP

O.SCP.RECOVERY

If there is a loss of power, or if the smart card is withdrawn from the CAD while an operation is in progress, the SCP must allow the TOE to eventually complete the interrupted operation successfully, or recover to a consistent and secure state.

This security objective refers to the security aspect #.SCP(1): The smart card platform must be secure with respect to the SFRs. Then after a power loss or sudden card removal prior to completion of some communication protocol, the SCP will allow the TOE on the next power up to either complete the interrupted operation or revert to a secure state.

O.SCP.IC

The SCP shall provide all IC security features against physical attacks.

This security objective refers to the point (7) of the security aspect #.SCP:

It is required that the IC is designed in accordance with a well-defined set of policies and Standards (likely specified in another protection profile), and will be tamper resistant to actually prevent an attacker from extracting or altering security data (like cryptographic keys) by using commonly employed techniques (physical probing and sophisticated analysis of the chip). This especially matters to the management (storage and operation) of cryptographic keys.

	Reference D1226479	Release 1.3p <small>(Printed copy not controlled: verify the version before using)</small>
	Classification level Public	Pages 177

4.1.3 (U)SIM

This section defines the security objectives to be achieved by the TOE(U)SIM.

O.Secure_API

The TOE shall provide to application a secure_API means to optimize control on sensitive operations performed by application.

TOE shall provide services for secure array management and to detect loss of data integrity and inconsistent execution flow and react against tearing or fault induction.

O.RND

The TOE must contribute to ensure that random numbers shall not be predictable and shall have sufficient entropy.

O.JCAPI-Services

The TOE must contribute to ensure that data manipulated during SHA and CRC services as defined in [JCAPI] shall not be observed.

O.REMOTE_SERVICE_AUDIT

The TOE shall perform remote service audit only when optional platform service audit is authorized and only by an authorized actor. Limited to [MNO or GemActivate Administrator (usually Gemalto)].

O.REMOTE_SERVICE_ACTIVATION

The TOE shall perform remote optional platform service activation only when service activation is authorized and only by an authorized actor. Limited to [GemActivate Administrator (usually Gemalto)]under control of [MNO].

O.EMVUtil_API

The TOE shall provide to banking application a secure_API to optimize control on sensitive object performed by application.

TOE shall provide services for secure container and counter management and to detect loss of data integrity.

4.2 Security objectives for the Operational Environment

4.2.1 (U)SIM Java card TM Platform Protection Profile

This section introduces the security objectives to be achieved by the environment associated to the TOE.

The significant security objectives for the environment of the TOE are the ones linked to relevant assumptions and OSPs.

	Reference D1226479	Release 1.3p <small>(Printed copy not controlled: verify the version before using)</small>
	Classification level Public	Pages 177

All the security objectives for the environment of the Java Card System Protection Profile [PP-JCS] are relevant to this Protection Profile except Card Management security objectives which are now part of the TOE.

The specific environment security objectives concerning the (U)SIM Platform are listed below:

4.2.1.1 Basic TOE

Actors

OE.MOBILE-OPERATOR

The mobile operator shall be a trusted actor responsible for the mobile network and the associated OTA servers.

OE.OTA-ADMIN

Administrators of the mobile operator OTA servers shall be trusted people. They shall be trained to use and administrate those servers. They have the means and the equipments to perform their tasks.

They must be aware of the sensitivity of the assets they manage and the responsibilities associated to the administration of OTA servers.

Application note:

One possible realisation of this assumption is the enforcement of security rules defined in an OTA servers security guidance document with regular site inspections to check the applicability of the rules

OE.APPS-PROVIDER

The AP shall be a trusted actor that provides standard or secure application. He must be responsible of his security domain keys.

OE.VERIFICATION-AUTHORITY

The VA should be a trusted actor who is able to guarantee and check the digital signature attached to an application.

OE.KEY-ESCROW

The key escrow shall be a trusted actor in charge of the secure storage of the AP initial keys generated by the personalizer.

OE.PERSONALIZER

The personalizer shall be a trusted actor in charge of the personalization process. He must ensure the security of the keys it manages and loads into the card:

Mobile operator keys including OTA keys (telecom keys either generated by the personalizer or by the mobile operator),

Issuer Security Domain keys (ISD keys),

Application Provider Security Domain keys (APSD keys).

Controlling Authority Security Domain keys (CASD keys)

	Reference D1226479	Release 1.3p <small>(Printed copy not controlled: verify the version before using)</small>
	Classification level Public	Pages 177

Keys

OE.AP-KEYS

The SD keys personalizer, the AP and the key escrow must enforce a security policy on SD keys in order to secure their transmission.

OE.OPERATOR-KEYS

The security of the mobile operator keys must be ensured in the environment of the TOE.

OE.KEY-GENERATION

The personalizer must ensure that the generated keys cannot be accessed by unauthorized users.

OE.CA-KEYS

The security domain keys of the CA must be securely generated prior storage in the (U)SIM card.

OE.VA-KEYS

The security domain keys of the VA must be securely generated prior storage in the (U)SIM card.

Platform

OE.KEY-CHANGE

The AP must change its security domain initial keys before any operation on it.

GP

OE.SECURITY-DOMAINS

Security domains can be dynamically created, deleted and blocked during usage phase in post-issuance mode.

OE.QUOTAS

Security domains are subject to quotas of memory at creation.

Applications

OE.SHARE-CONTROL

All applications (standard and secure applications) must have means to identify the applications with whom they share data using the Shareable Interface.

Application note:

If an application implementing a Shareable Interface has to share data with a new application, it has to be updated, and thus re-validated, to take into account the identification of this new application (through its AID for instance) before sharing data.

	Reference	D1226479	Release	1.3p <small>(Printed copy not controlled: verify the version before using)</small>
	Classification level	Public	Pages	177

4.2.2 Java Card System Protection Profile - Open Configuration

This section introduces the security objectives to be achieved by the environment.

OE.APPLET

No applet loaded post-issuance shall contain native methods.

OE.VERIFICATION

All the bytecodes shall be verified at least once, before the loading, before the installation or before the execution, depending on the card capabilities, in order to ensure that each bytecode is valid at execution time. See #.VERIFICATION for details.

4.2.3 (U)SIM

OE.TRUSTED-APPS-DEVELOPER

The trusted application developer shall be a trusted actor that provides basic or secure application where correct usage of the TOE has been verified applying a secure development process in secure development environment.

OE.TRUSTED-APPS-PRE-ISSUANCE LOADING

The trusted pre-issuance loading on the platform must be done only using verified applet applying an audited process in a secure environment.

OE.ACTIVATION-KEY-ESCROW

The key escrow is a trusted actor must ensure the security of the keys used for remote service activation during generation, storage, importation in TOE and usage.

4.3 Security Objectives Rationale

4.3.1 Threats

4.3.1.1 (U)SIM Java card TM Platform Protection Profile

Basic TOE

T.PHYSICAL This threat is countered by physical protections which rely on the underlying platform and are therefore an environmental issue.

The security objectives O.SCP-SUPPORT and O.SCP.IC protect sensitive assets of the platform against loss of integrity and confidentiality and especially ensure the TSFs cannot be bypassed or altered. Physical protections rely on the underlying platform and are therefore an environmental issue.

	Reference D1226479	Release 1.3p <small>(Printed copy not controlled: verify the version before using)</small>
	Classification level Public	Pages 177

T.INTEG-USER-DATA The security objective O.SCP-SUPPORT provides functionality to ensure atomicity of sensitive operations, secure low level access control and protection against bypassing of the security features of the TOE. In particular, it explicitly ensures the independent protection in integrity of the platform data.

The security objectives O.DOMAIN-RIGHTS, OE.CA-KEYS, OE.VA-KEYS and OE.AP-KEYS ensure that personalization of the application by its associated security domain is only performed by the authorized AP.

The security objectives from [PP-JCS] covering the threat T.INTEG-APPLI-DATA also cover this threat.

T.COM_EXPLOIT This threat is covered by the following security objectives:

O.COMM_AUTH prevents unauthorized users from initiating a malicious card management operation.

O.COMM_INTEGRITY protects the integrity of the card management data while it is in transit to the (U)SIM card.

O.COMM_CONFIDENTIALITY prevents from disclosing encrypted data transiting to the (U)SIM card.

T.UNAUTHORIZED_CARD_MNGT This threat is covered by the following security objectives:

O.CARD-MANAGEMENT controls the access to card management functions such as the loading, installation, extradition or deletion of applets.

O.COMM_AUTH prevents unauthorized users from initiating a malicious card management operation.

O.COMM_INTEGRITY protects the integrity of the card management data while it is in transit to the (U)SIM card.

O.APPLI-AUTH which requires for loading all applications to be authenticated.

O.DOMAIN-RIGHTS which restricts the modification of an AP security domain keyset to the AP who owns it.

T.LIFE_CYCLE This threat is covered by the security objectives:

O.CARD-MANAGEMENT that controls the access to card management functions such as the loading, installation, extradition or deletion of applets and prevent attacks intended to modify or exploit the current life cycle of applications

O.DOMAIN-RIGHTS that restricts the use of an AP security domain keysets, and thus the management of the applications related to this SD, to the AP who owns it.

	Reference D1226479	Release 1.3p <small>(Printed copy not controlled: verify the version before using)</small>
	Classification level Public	Pages 177

T.UNAUTHORIZED_ACCESS This threat is covered by the security objective on the operational environment of the TOE OE.SHARE-CONTROL which ensures that sharing objects functionality is strictly controlled to stop data transitive flows between applets and thus stop access to unauthorized data.

4.3.1.2 Java Card System Protection Profile - Open Configuration

CONFIDENTIALITY

T.CONFID-APPLI-DATA This threat is countered by the security objective for the operational environment regarding bytecode verification (OE.VERIFICATION) and guide application (OE.BASIC-APPS-VALIDATION). It is also covered by the isolation commitments stated in the (O.FIREWALL) objective. It relies in its turn on the correct identification of applets stated in (O.SID). Moreover, as the firewall is dynamically enforced, it shall never stop operating, as stated in the (O.OPERATE) objective.

As the firewall is a software tool automating critical controls, the objective O.ALARM asks for it to provide clear warning and error messages, so that the appropriate counter-measure can be taken.

The objectives O.CARD-MANAGEMENT and OE.VERIFICATION contribute to cover this threat by controlling the access to card management functions and by checking the bytecode, respectively.

The objectives O.SCP.RECOVERY and O.SCP-SUPPORT are intended to support the O.OPERATE and O.ALARM objectives of the TOE, so they are indirectly related to the threats that these latter objectives contribute to counter.

As applets may need to share some data or communicate with the CAD, cryptographic functions are required to actually protect the exchanged information (O.CIPHER). Remark that even if the TOE shall provide access to the appropriate TSFs, it is still the responsibility of the applets to use them. Keys, PIN's are particular cases of an application's sensitive data (the Java Card System may possess keys as well) that ask for appropriate management (O.KEY-MNGT, O.PIN-MNGT, O.TRANSACTION). If the PIN class of the Java Card API is used, the objective (O.FIREWALL) shall contribute in covering this threat by controlling the sharing of the global PIN between the applets.

Other application data that is sent to the applet as clear text arrives to the APDU buffer, which is a resource shared by all applications. The disclosure of such data is prevented by the security objective O.GLOBAL_ARRAYS_CONFID.

Finally, any attempt to read a piece of information that was previously used by an application but has been logically deleted is countered by the O.REALLOCATION objective. That objective states that any information that was formerly stored in a memory block shall be cleared before the block is reused.

	Reference D1226479	Release 1.3p <small>(Printed copy not controlled: verify the version before using)</small>
	Classification level Public	Pages 177

T.CONFID-JCS-CODE This threat is countered by the list of properties described in the (#.VERIFICATION) security aspect. Bytecode verification ensures that each of the instructions used on the Java Card platform is used for its intended purpose and in the intended scope of accessibility. As none of those instructions enables reading a piece of code, no Java Card applet can therefore be executed to disclose a piece of code. Native applications are also harmless because of the objective O.NATIVE and OE.BASIC-APPS-VALIDATION, so no application can be run to disclose a piece of code.

The (#.VERIFICATION) security aspect is addressed in this PP by the objective for the environment OE.VERIFICATION.

The objectives O.CARD-MANAGEMENT and OE.VERIFICATION contribute to cover this threat by controlling the access to card management functions and by checking the bytecode, respectively.

T.CONFID-JCS-DATA This threat is covered by bytecode verification (OE.VERIFICATION) and the isolation commitments stated in the (O.FIREWALL) security objective. This latter objective also relies in its turn on the correct identification of applets stated in (O.SID). Moreover, as the firewall is dynamically enforced, it shall never stop operating, as stated in the (O.OPERATE) objective.

As the firewall is a software tool automating critical controls, the objective O.ALARM asks for it to provide clear warning and error messages, so that the appropriate counter-measure can be taken.

The objectives O.CARD-MANAGEMENT and OE.VERIFICATION contribute to cover this threat by controlling the access to card management functions and by checking the bytecode, respectively.

The objectives O.SCP.RECOVERY and O.SCP-SUPPORT are intended to support the O.OPERATE and O.ALARM objectives of the TOE, so they are indirectly related to the threats that these latter objectives contribute to counter.

INTEGRITY

T.INTEG-APPLI-CODE This threat is countered by the list of properties described in the (#.VERIFICATION) security aspect. Bytecode verification ensures that each of the instructions used on the Java Card platform is used for its intended purpose and in the intended scope of accessibility. As none of these instructions enables modifying a piece of code, no Java Card applet can therefore be executed to modify a piece of code. Native applications are also harmless because of the objectives (O.NATIVE) and OE.BASIC-APPS-VALIDATION, so no application can be run to modify a piece of code.

The (#.VERIFICATION) security aspect is addressed in this configuration by the objective for the environment OE.VERIFICATION.

The objectives O.CARD-MANAGEMENT and OE.VERIFICATION contribute to cover this threat by controlling the access to card management functions and by checking the bytecode, respectively.

	Reference D1226479	Release 1.3p <small>(Printed copy not controlled: verify the version before using)</small>
	Classification level Public	Pages 177

T.INTEG-APPLI-CODE.LOAD This threat is countered by the security objective O.LOAD which ensures that the loading of packages is done securely and thus preserves the integrity of packages code.

By controlling the access to card management functions such as the installation, update or deletion of applets the objective O.CARD-MANAGEMENT contributes to cover this threat.

T.INTEG-APPLI-DATA This threat is countered by bytecode verification (OE.VERIFICATION and OE.BASIC-APPS-VALIDATION) and the isolation commitments stated in the (O.FIREWALL) objective. This latter objective also relies in its turn on the correct identification of applets stated in (O.SID). Moreover, as the firewall is dynamically enforced, it shall never stop operating, as stated in the (O.OPERATE) objective.

As the firewall is a software tool automating critical controls, the objective O.ALARM asks for it to provide clear warning and error messages, so that the appropriate counter-measure can be taken.

The objectives O.CARD-MANAGEMENT and OE.VERIFICATION contribute to cover this threat by controlling the access to card management functions and by checking the bytecode, respectively.

The objectives O.SCP.RECOVERY and O.SCP-SUPPORT are intended to support the O.OPERATE and O.ALARM objectives of the TOE, so they are indirectly related to the threats that these latter objectives contribute to counter.

Concerning the confidentiality and integrity of application sensitive data, as applets may need to share some data or communicate with the CAD, cryptographic functions are required to actually protect the exchanged information (O.CIPHER). Remark that even if the TOE shall provide access to the appropriate TSFs, it is still the responsibility of the applets to use them. Keys and PIN's are particular cases of an application's sensitive data (the Java Card System may possess keys as well) that ask for appropriate management (O.KEY-MNGT, O.PIN-MNGT, O.TRANSACTION). If the PIN class of the Java Card API is used, the objective (O.FIREWALL) is also concerned.

Other application data that is sent to the applet as clear text arrives to the APDU buffer, which is a resource shared by all applications. The integrity of the information stored in that buffer is ensured by the objective O.GLOBAL_ARRAYS_INTEG.

Finally, any attempt to read a piece of information that was previously used by an application but has been logically deleted is countered by the O.REALLOCATION objective. That objective states that any information that was formerly stored in a memory block shall be cleared before the block is reused.

T.INTEG-APPLI-DATA.LOAD This threat is countered by the security objective O.LOAD which ensures that the loading of packages is done securely and thus preserves the integrity of applications data.

By controlling the access to card management functions such as the installation, update or deletion of applets the objective O.CARD-MANAGEMENT contributes to cover this threat.

T.INTEG-JCS-CODE This threat is countered by the list of properties described in the (#.VERIFICATION) security aspect. Bytecode verification ensures that each of the instructions used on the Java Card platform is used for its intended purpose and in the

	Reference	D1226479	Release	1.3p <small>(Printed copy not controlled: verify the version before using)</small>
	Classification level	Public	Pages	177

intended scope of accessibility. As none of these instructions enables modifying a piece of code, no Java Card applet can therefore be executed to modify a piece of code. Native applications are also harmless because of the objectives O.NATIVE and OE.BASIC-APPS-VALIDATION, so no application can be run to modify a piece of code.

The (#.VERIFICATION) security aspect is addressed in this configuration by the objective for the environment OE.VERIFICATION.

The objectives O.CARD-MANAGEMENT and OE.VERIFICATION contribute to cover this threat by controlling the access to card management functions and by checking the bytecode, respectively.

T.INTEG-JCS-DATA This threat is countered by bytecode verification (OE.VERIFICATION) and guidance verification (OE.BASIC-APPS-VALIDATION) and the isolation commitments stated in the (O.FIREWALL) objective. This latter objective also relies in its turn on the correct identification of applets stated in (O.SID). Moreover, as the firewall is dynamically enforced, it shall never stop operating, as stated in the (O.OPERATE) objective.

As the firewall is a software tool automating critical controls, the objective O.ALARM asks for it to provide clear warning and error messages, so that the appropriate counter-measure can be taken.

The objectives O.CARD-MANAGEMENT and OE.VERIFICATION contribute to cover this threat by controlling the access to card management functions and by checking the bytecode, respectively.

The objectives O.SCP.RECOVERY and O.SCP-SUPPORT are intended to support the O.OPERATE and O.ALARM objectives of the TOE, so they are indirectly related to the threats that these latter objectives contribute to counter.

IDENTITY USURPATION

T.SID.1 As impersonation is usually the result of successfully disclosing and modifying some assets, this threat is mainly countered by the objectives concerning the isolation of application data (like PINs), ensured by the (O.FIREWALL). Uniqueness of subject-identity (O.SID) also participates to face this threat. It should be noticed that the AIDs, which are used for applet identification, are TSF data.

In this configuration, usurpation of identity resulting from a malicious installation of an applet on the card is covered by the objective O.INSTALL.

The installation parameters of an applet (like its name) are loaded into a global array that is also shared by all the applications. The disclosure of those parameters (which could be used to impersonate the applet) is countered by the objectives O.GLOBAL_ARRAYS_CONFID and O.GLOBAL_ARRAYS_INTEG.

The objective O.CARD-MANAGEMENT contributes, by preventing usurpation of identity resulting from a malicious installation of an applet on the card, to counter this threat.

T.SID.2 This is covered by integrity of TSF data, subject-identification (O.SID), the firewall (O.FIREWALL) and its good working order (O.OPERATE).

The objective O.INSTALL contributes to counter this threat by ensuring that installing an applet has no effect on the state of other applets and thus can't change the TOE's attribution of privileged roles.

	Reference	D1226479	Release	1.3p <small>(Printed copy not controlled: verify the version before using)</small>
	Classification level	Public	Pages	177

The objectives O.SCP.RECOVERY and O.SCP-SUPPORT are intended to support the O.OPERATE objective of the TOE, so they are indirectly related to the threats that this latter objective contributes to counter.

UNAUTHORIZED EXECUTION

T.EXE-CODE.1 Unauthorized execution of a method is prevented by the objectives OE.VERIFICATION and OE.BASIC-APPS-VALIDATION. This threat particularly concerns the point (8) of the security aspect #VERIFICATION (access modifiers and scope of accessibility for classes, fields and methods). The O.FIREWALL objective is also concerned, because it prevents the execution of non-shareable methods of a class instance by any subject apart from the class instance owner.

T.EXE-CODE.2 Unauthorized execution of a method fragment or arbitrary data is prevented by the objectives OE.VERIFICATION and OE.BASIC-APPS-VALIDATION. This threat particularly concerns those points of the security aspect related to control flow confinement and the validity of the method references used in the bytecodes.

T.EXE-CODE-REMOTE The O.REMOTE security objective contributes to prevent the invocation of a method that is not supposed to be accessible from outside the card.

T.NATIVE This threat is countered by O.NATIVE which ensures that a Java Card applet can only access native methods indirectly that is, through an API which is assumed to be secure thanks to OE.BASIC-APPS-VALIDATION. OE.APPLLET also covers this threat by ensuring that no native applets shall be loaded in post-issuance. In addition to this, the bytecode verifier also prevents the program counter of an applet to jump into a piece of native code by confining the control flow to the currently executed methods OE.VERIFICATION and OE.BASIC-APPS-VALIDATION.

DENIAL OF SERVICE

T.RESOURCES This threat is directly countered by objectives on resource-management (O.RESOURCES) for runtime purposes and good working order (O.OPERATE) in a general manner.

Consumption of resources during installation and other card management operations are covered, in case of failure, by O.INSTALL.

It should be noticed that, for what relates to CPU usage, the Java Card platform is single-threaded and it is possible for an ill-formed application (either native or not) to monopolize the CPU. However, a smart card can be physically interrupted (card removal or hardware reset) and most CADs implement a timeout policy that prevent them from being blocked should a card fails to answer. That point is out of scope of this Protection Profile, though.

Finally, the objectives O.SCP.RECOVERY and O.SCP-SUPPORT are intended to support the O.OPERATE and O.RESOURCES objectives of the TOE, so they are indirectly related to the threats that these latter objectives contribute to counter.

	Reference D1226479	Release 1.3p <small>(Printed copy not controlled: verify the version before using)</small>
	Classification level Public	Pages 177

CARD MANAGEMENT

T.DELETION This threat is covered by the O.DELETION security objective which ensures that both applet and package deletion perform as expected.

The objective O.CARD-MANAGEMENT controls the access to card management functions and thus contributes to cover this threat.

T.INSTALL This threat is covered by the security objective O.INSTALL which ensures that the installation of an applet performs as expected and the security objectives O.LOAD which ensures that the loading of a package into the card is safe.

The objective O.CARD-MANAGEMENT controls the access to card management functions and thus contributes to cover this threat.

	Reference	D1226479	Release	1.3p <small>(Printed copy not controlled: verify the version before using)</small>
	Classification level	Public	Pages	177

SERVICES

T.OBJ-DELETION This threat is covered by the O.OBJ-DELETION security objective which ensures that object deletion shall not break references to objects.

4.3.1.3 (U)SIM

T.UNAUTHORIZED_ACCESS_TO_SERVICE This threat is countered by the security objectives O.REMOTE_SERVICE_ACTIVATION and OE.GEMACTIVATE-ADMIN where only authorized and trusted actor is able to activate optional services.

4.3.2 Organisational Security Policies

4.3.2.1 (U)SIM Java card TM Platform Protection Profile

Basic TOE

Standard and secure applications policies

OSP.SECURE-APPS-CERTIFICATION This OSP is enforced by the security objective for the operational environment of the TOE OE.SECURE-APPS-CERTIFICATION.

OSP.BASIC-APPS-VALIDATION This OSP is enforced by the security objective for the operational environment of the TOE OE.BASIC-APPS-VALIDATION.

OSP.SHARE-CONTROL This OSP is directly enforced by the security objective for the operational environment of the TOE OE.SHARE-CONTROL.

OSP.AID-MANAGEMENT This OSP is directly enforced by the security objective for the operational environment of the TOE OE.AID-MANAGEMENT.

Loading policies

OSP.OTA-LOADING This OSP is enforced by the security objective for the operational environment of the TOE OE.OTA-LOADING.

OSP.OTA-SERVERS This OSP is enforced by the security objective for the operational environment of the TOE OE.OTA-SERVERS.

Key Policies

OSP.APSD-KEYS This OSP is enforced by the security objective for the operational environment of the TOE OE.AP-KEYS.

OSP.OPERATOR-KEYS This OSP is enforced by the security objective for the operational environment of the TOE OE.OPERATOR-KEYS.

OSP.KEY-GENERATION This OSP is enforced by the security objective for the operational environment of the TOE OE.KEY-GENERATION.

	Reference D1226479	Release 1.3p <small>(Printed copy not controlled: verify the version before using)</small>
	Classification level Public	Pages 177

OSP.CASD-KEYS This OSP is enforced by the security objective for the operational environment of the TOE OE.CA-KEYS.

OSP.VASD-KEYS This OSP is enforced by the security objective for the operational environment of the TOE OE.VA-KEYS.

Platform

OSP.KEY-CHANGE This OSP is enforced by the security objective for the operational environment of the TOE OE.KEY-CHANGE.

GP

OSP.SECURITY-DOMAINS This OSP is enforced by the security objective for the operational environment of the TOE OE.SECURITY-DOMAINS.

OSP.QUOTAS This OSP is enforced by the security objective for the operational environment of the TOE OE.QUOTAS.

Secure places

OSP.PRODUCTION This OSP is directly upheld by OE.PRODUCTION.

OSP.PERSONALIZER This OSP is directly upheld by OE.PERSONALIZER.

OSP.KEY-ESCROW This Security policy is directly upheld by OE.KEY-ESCROW.

4.3.2.2 Java Card System Protection Profile - Open Configuration

OSP.VERIFICATION This policy is upheld by the security objectives of the environment OE.VERIFICATION and OE.BASIC-APPS-VALIDATION which guarantees that all the bytecodes shall be verified at least once, before the loading, before the installation or before the execution in order to ensure that each bytecode is valid at execution time.

4.3.2.3 (U)SIM

OSP.SecureAPI This OSP is enforced by the TOE security objective O.Secure_API.

OSP.RNG This OSP is enforced by the TOE security objective O.RND.

OSP.JCAPI-Services This OSP is enforced by the TOE security objective O.JCAPI-Services.

OSP.TRUSTED-APPS-DEVELOPER This OSP is enforced by the security objective OE.TRUSTED-APPS-DEVELOPER.

OSP.TRUSTED-APPS-PRE-ISSUANCE LOADING This OSP is enforced by the security objective OE.TRUSTED-APPS-PRE-ISSUANCE LOADING.

	Reference	D1226479	Release	1.3p <small>(Printed copy not controlled: verify the version before using)</small>
	Classification level	Public	Pages	177

OSP.SERVICE_AUDIT This OSP is directly enforced by the security objective O.REMOTE_SERVICE_AUDIT.

OSP.ACTIVATION-KEY-ESCROW This OSP is enforced by the security objective OE.ACTIVATION-KEY-ESCROW.

OSP.EMVUtil_API This OSP is enforced by the TOE security objective O.EMVUtil_API.

4.3.3 Assumptions

4.3.3.1 (U)SIM Java card TM Platform Protection Profile

Actors

A.MOBILE-OPERATOR This assumption is directly upheld by OE.MOBILE-OPERATOR.

A.OTA-ADMIN This assumption is directly upheld by OE.OTA-ADMIN.

A.APPS-PROVIDER This assumption is directly upheld by OE.APPS-PROVIDER.

A.VERIFICATION-AUTHORITY This assumption is directly upheld by OE.VERIFICATION-AUTHORITY.

A.CONTROLLING-AUTHORITY This assumption is directly upheld by OE.CONTROLLING-AUTHORITY.

4.3.3.2 Java Card System Protection Profile - Open Configuration

A.APPLET This assumption is upheld by the security objective for the operational environment OE.APPLET which ensures that no applet loaded post-issuance shall contain native methods.

A.VERIFICATION This assumption is upheld by the security objective on the operational environment OE.VERIFICATION which guarantees that all the bytecodes shall be verified at least once, before the loading, before the installation or before the execution in order to ensure that each bytecode is valid at execution time.

4.3.4 Security Objectives for the TOE

4.3.4.1 (U)SIM Java card TM Platform Protection Profile

Basic TOE

Card Management

O.DOMAIN-RIGHTS This objective participates to cover the following threats: T.LIFE_CYCLE, T.UNAUTHORIZED_CARD_MNGT, and T.INTEG-USER-DATA.

4.3.5 SPD and Security Objectives

Threats	Security Objectives	Rationale
T.PHYSICAL	O.SCP.IC , O.SCP-SUPPORT	Section 2.3.1
T.INTEG-USER-DATA	O.DOMAIN-RIGHTS , OE.CA-KEYS , OE.AP-KEYS , OE.VA-KEYS , O.SCP-SUPPORT	Section 2.3.1
T.COM_EXPLOIT	O.COMM AUTH , O.COMM INTEGRITY , O.COMM CONFIDENTIALITY	Section 2.3.1
T.UNAUTHORIZED_CARD_MNGT	O.CARD-MANAGEMENT , O.COMM AUTH , O.COMM INTEGRITY , O.APPLI-AUTH , O.DOMAIN-RIGHTS	Section 2.3.1
T.LIFE_CYCLE	O.CARD-MANAGEMENT , O.DOMAIN-RIGHTS	Section 2.3.1
T.UNAUTHORIZED_ACCESS	OE.SHARE-CONTROL	Section 2.3.1
T.CONFID-APPLI-DATA	OE.VERIFICATION , O.SID , O.OPERATE , O.FIREWALL , O.GLOBAL ARRAYS CONFID , O.ALARM , O.TRANSACTION , O.CIPHER , O.PIN-MNGT , O.KEY-MNGT , O.REALLOCATION , O.SCP-SUPPORT , O.SCP.RECOVERY , OE.BASIC-APPS-VALIDATION , O.CARD-MANAGEMENT	Section 2.3.1
T.CONFID-JCS-CODE	OE.VERIFICATION , O.NATIVE , OE.BASIC-APPS-VALIDATION , O.CARD-MANAGEMENT	Section 2.3.1
T.CONFID-JCS-DATA	OE.VERIFICATION , O.SID , O.OPERATE , O.FIREWALL , O.ALARM , O.SCP-SUPPORT , O.SCP.RECOVERY , O.CARD-MANAGEMENT	Section 2.3.1
T.INTEG-APPLI-CODE	OE.VERIFICATION , O.NATIVE , O.CARD-MANAGEMENT , OE.BASIC-APPS-VALIDATION	Section 2.3.1
T.INTEG-APPLI-CODE.LOAD	O.LOAD , O.CARD-MANAGEMENT	Section 2.3.1

Threats	Security Objectives	Rationale
T.INTEG-APPLI-DATA	OE.VERIFICATION , O.SID , O.OPERATE , O.FIREWALL , O.GLOBAL_ARRAYS_INTEG , O.ALARM , O.TRANSACTION , O.CIPHER , O.PIN-MNGT , O.KEY-MNGT , O.REALLOCATION , O.SCP-SUPPORT , O.SCP.RECOVERY , O.CARD-MANAGEMENT , OE.BASIC-APPS-VALIDATION	Section 2.3.1
T.INTEG-APPLI-DATA.LOAD	O.LOAD , O.CARD-MANAGEMENT	Section 2.3.1
T.INTEG-JCS-CODE	OE.VERIFICATION , O.NATIVE , O.CARD-MANAGEMENT , OE.BASIC-APPS-VALIDATION	Section 2.3.1
T.INTEG-JCS-DATA	OE.VERIFICATION , O.SID , O.OPERATE , O.FIREWALL , O.ALARM , O.SCP-SUPPORT , O.SCP.RECOVERY , O.CARD-MANAGEMENT , OE.BASIC-APPS-VALIDATION	Section 2.3.1
T.SID.1	O.FIREWALL , O.GLOBAL_ARRAYS_CONFID , O.GLOBAL_ARRAYS_INTEG , O.INSTALL , O.SID , O.CARD-MANAGEMENT	Section 2.3.1
T.SID.2	O.SID , O.OPERATE , O.FIREWALL , O.INSTALL , O.SCP-SUPPORT , O.SCP.RECOVERY	Section 2.3.1
T.EXE-CODE.1	OE.VERIFICATION , O.FIREWALL , OE.BASIC-APPS-VALIDATION	Section 2.3.1
T.EXE-CODE.2	OE.VERIFICATION , OE.BASIC-APPS-VALIDATION	Section 2.3.1
T.EXE-CODE-REMOTE	O.REMOTE	Section 2.3.1
T.NATIVE	OE.VERIFICATION , OE.APPLET , O.NATIVE , OE.BASIC-APPS-VALIDATION	Section 2.3.1
T.RESOURCES	O.INSTALL , O.OPERATE , O.RESOURCES , O.SCP-SUPPORT , O.SCP.RECOVERY	Section 2.3.1

	Reference	D1226479	Release	1.3p <small>(Printed copy not controlled: verify the version before using)</small>
	Classification level	Public	Pages	177

Threats	Security Objectives	Rationale
T.DELETION	O.DELETION , O.CARD-MANAGEMENT	Section 2.3.1
T.INSTALL	O.INSTALL , O.LOAD , O.CARD-MANAGEMENT	Section 2.3.1
T.OBJ-DELETION	O.OBJ-DELETION	Section 2.3.1
T.UNAUTHORIZED ACCESS TO SERVICE	O.REMOTE SERVICE ACTIVATION , OE.GEMACTIVATE-ADMIN	Section 2.3.1

Table 8 Threats and Security Objectives - Coverage

Security Objectives	Threats	Rationale
O.CARD-MANAGEMENT	T.UNAUTHORIZED CARD MNGT , T.LIFE_CYCLE , T.CONFID-APPLI-DATA , T.CONFID-JCS-CODE , T.CONFID-JCS-DATA , T.INTEG-APPLI-CODE , T.INTEG-APPLI-CODE.LOAD , T.INTEG-APPLI-DATA , T.INTEG-APPLI-DATA.LOAD , T.INTEG-JCS-CODE , T.INTEG-JCS-DATA , T.SID.1 , T.DELETION , T.INSTALL	
O.DOMAIN-RIGHTS	T.INTEG-USER-DATA , T.UNAUTHORIZED CARD MNGT , T.LIFE_CYCLE	Section 2.3.4
O.APPLI-AUTH	T.UNAUTHORIZED CARD MNGT	
O.COMM_AUTH	T.COM_EXPLOIT , T.UNAUTHORIZED CARD MNGT	
O.COMM INTEGRITY	T.COM_EXPLOIT , T.UNAUTHORIZED CARD MNGT	
O.COMM_CONFIDENTIALITY	T.COM_EXPLOIT	
O.SCP-SUPPORT	T.PHYSICAL , T.INTEG-USER-DATA , T.CONFID-APPLI-DATA , T.CONFID-JCS-DATA , T.INTEG-APPLI-DATA , T.INTEG-JCS-DATA , T.SID.2 , T.RESOURCES	
O.SID	T.CONFID-APPLI-DATA , T.CONFID-JCS-DATA , T.INTEG-APPLI-DATA , T.INTEG-JCS-DATA , T.SID.1 , T.SID.2	
O.FIREWALL	T.CONFID-APPLI-DATA , T.CONFID-JCS-DATA , T.INTEG-APPLI-DATA , T.INTEG-JCS-DATA , T.SID.1 , T.SID.2 , T.EXE-CODE.1	
O.GLOBAL ARRAYS CONFID	T.CONFID-APPLI-DATA , T.SID.1	
O.GLOBAL ARRAYS INTEG	T.INTEG-APPLI-DATA , T.SID.1	
O.NATIVE	T.CONFID-JCS-CODE , T.INTEG-APPLI-CODE , T.INTEG-JCS-CODE , T.NATIVE	
O.OPERATE	T.CONFID-APPLI-DATA , T.CONFID-JCS-DATA , T.INTEG-APPLI-DATA , T.INTEG-JCS-DATA , T.SID.2 , T.RESOURCES	
O.REALLOCATION	T.CONFID-APPLI-DATA , T.INTEG-APPLI-DATA	
O.RESOURCES	T.RESOURCES	

Security Objectives	Threats	Rationale
O.ALARM	T.CONFID-APPLI-DATA , T.CONFID-JCS-DATA , T.INTEG-APPLI-DATA , T.INTEG-JCS-DATA	
O.CIPHER	T.CONFID-APPLI-DATA , T.INTEG-APPLI-DATA	
O.KEY-MNGT	T.CONFID-APPLI-DATA , T.INTEG-APPLI-DATA	
O.PIN-MNGT	T.CONFID-APPLI-DATA , T.INTEG-APPLI-DATA	
O.REMOTE	T.EXE-CODE-REMOTE	
O.TRANSACTION	T.CONFID-APPLI-DATA , T.INTEG-APPLI-DATA	
O.OBJ-DELETION	T.OBJ-DELETION	
O.DELETION	T.DELETION	
O.LOAD	T.INTEG-APPLI-CODE.LOAD , T.INTEG-APPLI-DATA.LOAD , T.INSTALL	
O.INSTALL	T.SID.1 , T.SID.2 , T.RESOURCES , T.INSTALL	
O.SCP.RECOVERY	T.CONFID-APPLI-DATA , T.CONFID-JCS-DATA , T.INTEG-APPLI-DATA , T.INTEG-JCS-DATA , T.SID.2 , T.RESOURCES	
O.SCP.IC	T.PHYSICAL	
O.Secure API		
O.RND		
O.JCAPI-Services		
O.REMOTE_SERVICE_AUDIT		
O.REMOTE_SERVICE_ACTIVATION	T.UNAUTHORIZED_ACCESS_TO_SERVICE	
O.EMVUtil API		
OE.MOBILE-OPERATOR		
OE.OTA-ADMIN		
OE.APPS-PROVIDER		
OE.VERIFICATION-AUTHORITY		
OE.KEY-ESCROW		
OE.PERSONALIZER		
OE.CONTROLLING-AUTHORITY		

	Reference	D1226479	Release	1.3p <small>(Printed copy not controlled: verify the version before using)</small>
	Classification level	Public	Pages	177

Security Objectives	Threats	Rationale
OE.GEMACTIVATE-ADMIN	T.UNAUTHORIZED ACCESS TO SERVICE	
OE.PRODUCTION		
OE.SECURE-APPS-CERTIFICATION		
OE.BASIC-APPS-VALIDATION	T.CONFID-APPLI-DATA , T.CONFID-JCS-CODE , T.INTEG-APPLI-CODE , T.INTEG-APPLI-DATA , T.INTEG-JCS-CODE , T.INTEG-JCS-DATA , T.EXE-CODE.1 , T.EXE-CODE.2 , T.NATIVE	
OE.AID-MANAGEMENT		
OE.OTA-LOADING		
OE.OTA-SERVERS		
OE.AP-KEYS	T.INTEG-USER-DATA	
OE.OPERATOR-KEYS		
OE.KEY-GENERATION		
OE.CA-KEYS	T.INTEG-USER-DATA	
OE.VA-KEYS	T.INTEG-USER-DATA	
OE.KEY-CHANGE		
OE.SECURITY-DOMAINS		
OE.QUOTAS		
OE.SHARE-CONTROL	T.UNAUTHORIZED ACCESS	
OE.APPLLET	T.NATIVE	
OE.VERIFICATION	T.CONFID-APPLI-DATA , T.CONFID-JCS-CODE , T.CONFID-JCS-DATA , T.INTEG-APPLI-CODE , T.INTEG-APPLI-DATA , T.INTEG-JCS-CODE , T.INTEG-JCS-DATA , T.EXE-CODE.1 , T.EXE-CODE.2 , T.NATIVE	
OE.TRUSTED-APPS-DEVELOPER		
OE.TRUSTED-APPS-PRE-ISSUANCE LOADING		
OE.ACTIVATION-KEY-ESCROW		

Table 9 Security Objectives and Threats - Coverage

	Reference	D1226479	Release	1.3p <small>(Printed copy not controlled: verify the version before using)</small>
	Classification level	Public	Pages	177

Organisational Security Policies	Security Objectives	Rationale
OSP.SECURE-APPS-CERTIFICATION	OE.SECURE-APPS-CERTIFICATION	Section 2.3.2
OSP.BASIC-APPS-VALIDATION	OE.BASIC-APPS-VALIDATION	Section 2.3.2
OSP.SHARE-CONTROL	OE.SHARE-CONTROL	Section 2.3.2
OSP.AID-MANAGEMENT	OE.AID-MANAGEMENT	Section 2.3.2
OSP.OTA-LOADING	OE.OTA-LOADING	Section 2.3.2
OSP.OTA-SERVERS	OE.OTA-SERVERS	Section 2.3.2
OSP.APSD-KEYS	OE.AP-KEYS	Section 2.3.2
OSP.OPERATOR-KEYS	OE.OPERATOR-KEYS	Section 2.3.2
OSP.KEY-GENERATION	OE.KEY-GENERATION	Section 2.3.2
OSP.CASD-KEYS	OE.CA-KEYS	Section 2.3.2
OSP.VASD-KEYS	OE.VA-KEYS	Section 2.3.2
OSP.KEY-CHANGE	OE.KEY-CHANGE	Section 2.3.2
OSP.SECURITY-DOMAINS	OE.SECURITY-DOMAINS	Section 2.3.2
OSP.QUOTAS	OE.QUOTAS	Section 2.3.2
OSP.PRODUCTION	OE.PRODUCTION	Section 2.3.2
OSP.PERSONALIZER	OE.PERSONALIZER	Section 2.3.2
OSP.KEY-ESCROW	OE.KEY-ESCROW	Section 2.3.2
OSP.VERIFICATION	OE.VERIFICATION , OE.BASIC-APPS-VALIDATION	Section 2.3.2
OSP.SecureAPI	O.Secure API	Section 2.3.2
OSP.RNG	O.RND	Section 2.3.2
OSP.JCAPI-Services	O.JCAPI-Services	Section 2.3.2
OSP.TRUSTED-APPS-DEVELOPER	OE.TRUSTED-APPS-DEVELOPER	Section 2.3.2
OSP.TRUSTED-APPS-PRE-ISSUANCE LOADING	OE.TRUSTED-APPS-PRE-ISSUANCE LOADING	Section 2.3.2
OSP.SERVICE AUDIT	O.REMOTE SERVICE AUDIT	Section 2.3.2
OSP.ACTIVATION-KEY-ESCROW	OE.ACTIVATION-KEY-ESCROW	Section 2.3.2
OSP.EMVUtil API	O.EMVUtil API	Section 2.3.2

Table 10 OSPs and Security Objectives - Coverage

Security Objectives	Organisational Security Policies
O.CARD-MANAGEMENT	
O.DOMAIN-RIGHTS	
O.APPLI-AUTH	
O.COMM AUTH	
O.COMM INTEGRITY	
O.COMM_CONFIDENTIALITY	
O.SCP-SUPPORT	
O.SID	
O.FIREWALL	
O.GLOBAL_ARRAYS_CONFID	
O.GLOBAL_ARRAYS INTEG	
O.NATIVE	
O.OPERATE	
O.REALLOCATION	
O.RESOURCES	
O.ALARM	
O.CIPHER	
O.KEY-MNGT	
O.PIN-MNGT	
O.REMOTE	
O.TRANSACTION	
O.OBJ-DELETION	
O.DELETION	
O.LOAD	
O.INSTALL	
O.SCP.RECOVERY	
O.SCP.IC	
O.Secure API	OSP.SecureAPI
O.RND	OSP.RNG
O.JCAPI-Services	OSP.JCAPI-Services
O.REMOTE SERVICE AUDIT	OSP.SERVICE AUDIT
O.REMOTE SERVICE ACTIVATION	

Security Objectives	Organisational Security Policies
O.EMVUtil API	OSP.EMVUtil API
OE.MOBILE-OPERATOR	
OE.OTA-ADMIN	
OE.APPS-PROVIDER	
OE.VERIFICATION-AUTHORITY	
OE.KEY-ESCROW	OSP.KEY-ESCROW
OE.PERSONALIZER	OSP.PERSONALIZER
OE.CONTROLLING-AUTHORITY	
OE.GEMACTIVATE-ADMIN	
OE.PRODUCTION	OSP.PRODUCTION
OE.SECURE-APPS-CERTIFICATION	OSP.SECURE-APPS-CERTIFICATION
OE.BASIC-APPS-VALIDATION	OSP.VERIFICATION , OSP.BASIC-APPS-VALIDATION
OE.AID-MANAGEMENT	OSP.AID-MANAGEMENT
OE.OTA-LOADING	OSP.OTA-LOADING
OE.OTA-SERVERS	OSP.OTA-SERVERS
OE.AP-KEYS	OSP.APSD-KEYS
OE.OPERATOR-KEYS	OSP.OPERATOR-KEYS
OE.KEY-GENERATION	OSP.KEY-GENERATION
OE.CA-KEYS	OSP.CASD-KEYS
OE.VA-KEYS	OSP.VASD-KEYS
OE.KEY-CHANGE	OSP.KEY-CHANGE
OE.SECURITY-DOMAINS	OSP.SECURITY-DOMAINS
OE.QUOTAS	OSP.QUOTAS
OE.SHARE-CONTROL	OSP.SHARE-CONTROL
OE.APPLET	
OE.VERIFICATION	OSP.VERIFICATION
OE.TRUSTED-APPS-DEVELOPER	OSP.TRUSTED-APPS-DEVELOPER
OE.TRUSTED-APPS-PRE-ISSUANCE LOADING	OSP.TRUSTED-APPS-PRE-ISSUANCE LOADING
OE.ACTIVATION-KEY-ESCROW	OSP.ACTIVATION-KEY-ESCROW



	Reference	D1226479	Release	1.3p <small>(Printed copy not controlled: verify the version before using)</small>
	Classification level	Public	Pages	177

Table 11 Security Objectives and OSPs - Coverage

Assumptions	Security objectives for the Operational Environment	Rationale
A.MOBILE-OPERATOR	OE.MOBILE-OPERATOR	Section 2.3.3
A.OTA-ADMIN	OE.OTA-ADMIN	Section 2.3.3
A.APPS-PROVIDER	OE.APPS-PROVIDER	Section 2.3.3
A.VERIFICATION-AUTHORITY	OE.VERIFICATION-AUTHORITY	Section 2.3.3
A.CONTROLLING-AUTHORITY	OE.CONTROLLING-AUTHORITY	Section 2.3.3
A.APPLLET	OE.APPLLET	Section 2.3.3
A.VERIFICATION	OE.VERIFICATION	Section 2.3.3

Table 12 Assumptions and Security Objectives for the Operational Environment - Coverage

	Reference	D1226479	Release	1.3p <small>(Printed copy not controlled: verify the version before using)</small>
	Classification level	Public	Pages	177

Security objectives for the Operational Environment	Assumptions
OE.MOBILE-OPERATOR	A.MOBILE-OPERATOR
OE.OTA-ADMIN	A.OTA-ADMIN
OE.APPS-PROVIDER	A.APPS-PROVIDER
OE.VERIFICATION-AUTHORITY	A.VERIFICATION-AUTHORITY
OE.KEY-ESCROW	
OE.PERSONALIZER	
OE.CONTROLLING-AUTHORITY	A.CONTROLLING-AUTHORITY
OE.GEMACTIVATE-ADMIN	
OE.PRODUCTION	
OE.SECURE-APPS-CERTIFICATION	
OE.BASIC-APPS-VALIDATION	
OE.AID-MANAGEMENT	
OE.OTA-LOADING	
OE.OTA-SERVERS	
OE.AP-KEYS	
OE.OPERATOR-KEYS	
OE.KEY-GENERATION	
OE.CA-KEYS	
OE.VA-KEYS	
OE.KEY-CHANGE	
OE.SECURITY-DOMAINS	
OE.QUOTAS	
OE.SHARE-CONTROL	
OE.APPLET	A.APPLET
OE.VERIFICATION	A.VERIFICATION
OE.TRUSTED-APPS-DEVELOPER	
OE.TRUSTED-APPS-PRE-ISSUANCE LOADING	
OE.ACTIVATION-KEY-ESCROW	

Table 13 Security Objectives for the Operational Environment and Assumptions - Coverage

	Reference	D1226479	Release	1.3p <small>(Printed copy not controlled: verify the version before using)</small>
	Classification level	Public	Pages	177

5 Extended requirements

5.1 Extended families

5.1.1 Extended family FCS_RND - Random Number Generation

5.1.1.1 Description

This family defines quality requirements for the generation of random numbers which are intended to be used for cryptographic purposes.

5.1.1.2 Extended components

Extended component FCS_RND.1

Description

The generation of random numbers requires that random numbers meet a defined quality metric.

Definition

FCS_RND.1 Random Number Generation

FCS_RND.1.1 The TSF shall provide a mechanism to generate random numbers that meet [assignment: a defined quality metric].

Dependencies: No dependencies.

Rationale

It was chosen to define FCS_RNG.1 explicitly, because Part 2 of the Common Criteria do not contain generic security functional requirements for Random Number generation.

5.1.1.3 Rationale

This family has been introduced initially by IC manufacturer to offer unpredictable random number generation. It is extended here to software platform.

	Reference	D1226479	Release	1.3p <small>(Printed copy not controlled: verify the version before using)</small>
	Classification level	Public	Pages	177

6 Security Functional Requirements

6.1 Security Functional Requirements

6.1.1 (U)SIM Java card TM Platform Protection Profile

This section describes the requirements imposed on the TOE in order to achieve the security objectives laid down in the previous chapter. All the requirements identified in this section are instances of those stated in [CC-2].

The Java Card System Platform security functional requirements are included into this Protection Profile.

The SFRs listed below state requirements specific to the (U)SIM Platform.

6.1.1.1 Basic TOE

This section describes the SFR for the Basic TOE, applicable to [PPUSIM].

Card Manager (CMGRG)

This section contains the security requirements for the card manager.

The security requirements below help to define a policy for controlling access to card content management operations and for expressing card issuer security concerns. Most of them come from [JCS] but are instantiated to add more precisions regarding (U)SIM card content management. This policy depends on the particular security and card management architecture present in the card. Therefore the policy shall be instantiated when developing conformant Security Targets.

Card Content Management

FCS_COP.1/DAP Cryptographic operation

FCS_COP.1.1/DAP The TSF shall perform **verification of the DAP signature attached to Executable Load Applications** in accordance with a specified cryptographic algorithm

**PKC Scheme: SHA-1 hash and PKCS#1 RSA signature
or DES Scheme: Single DES plus final Triple DES MAC (Retail MAC)**

and cryptographic key sizes

**PKC Scheme: RSA key of minimum length 1024 bits
DES Scheme: DES key of minimum length 16 bytes**

that meets the following:

Sections C.1.2 and C.6 of [GP]

	Reference	D1226479	Release	1.3p <small>(Printed copy not controlled: verify the version before using)</small>
	Classification level	Public	Pages	177

PKC Scheme: SSA-PKCS1-v1_5 as defined in PKCS#1

DES Scheme: ISO 9797-1 as MAC Algorithm 3 with output transformation 3, without truncation, and with DES taking the place of the block cipher.

FDP_ITC.2/CCM Import of user data with security attributes

FDP_ITC.2.1/CCM The TSF shall enforce the **Security Domain access control policy and the Secure Channel Protocol information flow policy** when importing user data, controlled under the SFP, from outside of the TOE.

FDP_ITC.2.2/CCM The TSF shall use the security attributes associated with the imported user data.

FDP_ITC.2.3/CCM The TSF shall ensure that the protocol used provides for the unambiguous association between the security attributes and the user data received.

FDP_ITC.2.4/CCM The TSF shall ensure that interpretation of the security attributes of the imported user data is as intended by the source of the user data.

FDP_ITC.2.5/CCM The TSF shall enforce the following rules when importing user data controlled under the SFP from outside the TOE: **The loading of a new Executable Load File is allowed only if, AID attribute of each dependent Executable File is equal to the identified AID in the CAP File, such AID is unique, SD is personalized and authorized to load. Otherwise, the load of ELF is rejected.**

Application note:

This Functional Component Instance enforces a security information flow control policy. Rules must be defined for importation operations. These rules must take into account all user data.

FDP_ROL.1/CCM Basic rollback

FDP_ROL.1.1/CCM The TSF shall enforce **Security Domain access control policy** to permit the rollback of the **installation operation** on the **executable files and application instances**.

FDP_ROL.1.2/CCM The TSF shall permit operations to be rolled back within the **size of the available memory when the card content management operation starts**.

	Reference	D1226479	Release	1.3p <small>(Printed copy not controlled: verify the version before using)</small>
	Classification level	Public	Pages	177

FDP_UIT.1/CCM Data exchange integrity

FDP_UIT.1.1/CCM The TSF shall enforce the **Secure Channel Protocol information flow control policy and the Security Domain access control policy** to **transmit and receive** user data in a manner protected from **modification, deletion, insertion and replay** errors.

FDP_UIT.1.2/CCM The TSF shall be able to determine on receipt of user data, whether **modification, deletion, insertion and replay** has occurred.

FPT_FLS.1/CCM Failure with preservation of secure state

FPT_FLS.1.1/CCM The TSF shall preserve a secure state when the following types of failures occur: **the Security Domain fails to load/install an Executable File / application instance as described in GP22 §9.3.5.**

Security Domain

FDP_ACC.1/SD Subset access control

FDP_ACC.1.1/SD The TSF shall enforce the **Security Domain access control policy** on
Subjects: S.INSTALLER, S.ADEL, S.CAD (from [PP-JCS]) and S.SD
Objects: Delegation Token, DAP Block and Load File
Operations: GlobalPlatform's card content management APDU commands and API methods.

FDP_ACF.1/SD Security attributes based access control

FDP_ACF.1.1/SD The TSF shall enforce the **Security Domain access control policy** to objects based on the following:

Subjects:

S.INSTALLER, defined in [PP-JCS] and represented by the GlobalPlatform Environment (OPEN) on the card, the Card Life Cycle attributes (defined in Section 5.1.1 of [GP]);

S.ADEL, also defined in [PP-JCS] and represented by the GlobalPlatform Environment (OPEN) on the card;

S.SD receiving the Card Content Management commands (through APDUs or APIs) with a set of privileges (defined in Section 6.6.1 of [GP]), a life-cycle status (defined in Section 5.3.2 of [GP]) and a Secure Communication Security level (defined in Section 10.6 of [GP]);

	Reference	D1226479	Release	1.3p <small>(Printed copy not controlled: verify the version before using)</small>
	Classification level	Public	Pages	177

S.CAD, defined in [PP-JCS], the off-card entity that communicates with the S.INSTALLER through S.SD;

Objects:

The Delegation Token, in case of Delegated Management operations, with the attributes Present or Not Present;

The DAP Block, in case of application loading, with the attributes Present or Not Present;

The Load File or Executable File, in case of application loading, installation, extradition or registry update, with a set of intended privileges and its targeted associated SD AID.

the following security attributes:

The Default selected attribute specifies whether the applet instance is the one that should be executed when no application has been explicitly selected.

The Application State attribute specifies the current life cycle state of the application instance, which may be either SELECTABLE, APPLICATION_SPECIFIC, LOCKED.

The CardState attribute, is the current state in the life cycle of the card, which may be either OP_READY, INITIALIZED, SECURED, CARD_LOCKED, or TERMINATED.

The Card Lock attribute specifies whether the applet is allowed to temporary lock the services of the smart card.

The Card Termination attribute specifies whether the applet is allowed to definitely disable the services of the smart card.

The CVM attribute specifies whether the applet is allowed to modify the try limit and the PIN code of the global CVM service.

The Registered Applications attribute specifies the Executable Files and application instances that have been installed on the card so far and their dependencies.

FDP_ACF.1.2/SD The TSF shall enforce the following rules to determine if an operation among controlled subjects and controlled objects is allowed:

Runtime behavior rules defined by GlobalPlatform for:

- loading (Section 9.3.5 of [GP]);**
- installation (Section 9.3.6 of [GP]);**
- extradition (Section 9.4.1 of [GP]);**
- registry update (Section 9.4.2 of [GP]);**
- content removal (Section 9.5 of [GP]).**

FDP_ACF.1.3/SD The TSF shall explicitly authorise access of subjects to objects based on the following additional rules:

Rule SD-1: A card administration request may be accepted only if the APDU command specifying the request is well-formed according to [GP22].

	Reference	D1226479	Release	1.3p <small>(Printed copy not controlled: verify the version before using)</small>
	Classification level	Public	Pages	177

Rule SD-2: A card administration request other than requesting card management data may be accepted only if the Card State is not TERMINATED.

Rule SD-3: The selection of an applet instance may be accepted only if the Applet State is not LOCKED.

Rule SD-4: The update of the life cycle state of an application instance is accepted only if the new state is consistent with its current life cycle state according to GlobalPlatform's life cycle rules (either coming from an APDU command or from an application instance through the GP API).

Rule SD-5: A request for installing an Executable Load File may be accepted only if there is enough resources for loading the Executable File, and no Executable File on the card has been already registered with the specified AID.

Rule SD-6: A Executable Load File block may be loaded only if all its previous blocks have been received in order, and there are sufficient resources for storing the new one.

Rule SD-7: A new applet instance may be created only if the Package Properties enables applet instantiation or multiple applet instances (if there is already an instance for that applet) but also if the AID specified for the applet instance is not already used for another applet or Executable File installed on the card, and the privileges specified for it are consistent with the GlobalPlatform rules specified in [VGP].

Rule SD-8: An Executable File may be deleted from the smart card only if it is not reachable from other Executable Files or application instances on the card.

Rule SD-9: An applet instance may be deleted from the card only it is not currently active on a logical channel, and none of the resources it has allocated is reachable from other Executable Files or Application instances installed on the card.

Rule SD-10: An applet instance may lock the card only if it has the Card Lock privilege.

Rule SD-11: An applet instance may terminate the card only if it has the Card Termination privilege.

Rule SD-12: An applet instance may unlock the CVM service or modify the CVM try limit or PIN code only if it has the CVM privilege.

Rule SD-13: A request involving the use of any of the Security domain keys is accepted only if the concerned keys are integer.

FDP_ACF.1.4/SD The TSF shall explicitly deny access of subjects to objects based on the following additional rules: **following rule: when at least one of the rules defined by GlobalPlatform does not hold.**

	Reference	D1226479	Release	1.3p <small>(Printed copy not controlled: verify the version before using)</small>
	Classification level	Public	Pages	177

FMT_MSA.1/SD Management of security attributes

FMT_MSA.1.1/SD The TSF shall enforce the **Security Domain access control policy** to restrict the ability to **modify** the security attributes **any security attributes registered the GP Registry such as:**

Application state of an application instance (1)

Default selected application (2)

Card Life cycle state (3)

Package properties (4)

Application association (5)

to

the Security Domain and the application instance itself (1)

the Security Domain (2&4)

the Security Domain and application with privilege (Card Lock or Terminated)(3).

FMT_MSA.3/SD Static attribute initialisation

FMT_MSA.3.1/SD The TSF shall enforce the **Security Domain access control policy (see application note)** to provide **restrictive** default values for security attributes that are used to enforce the SFP.

FMT_MSA.3.2/SD The TSF shall allow the **Issuer or authorized application provider** to specify alternative initial values to override the default values when an object or information is created.

Refinement:

Alternative initial values shall be at least as restrictive as the default values defined in FMT_MSA.3.1.

The Default Selected application shall be the ISD.

The initial value of the Application State of an applet instance shall be SELECTABLE.

Application note:

When the TOE enters the life cycle phases under the scope of this Security Target, the Card State shall be at least SECURED.? The initial value of the Application State of an applet instance shall be SELECTABLE.? The initial Package Properties shall enable all card content management operations on the package.

Note: The Issuer or authorized application provider may assign the Default Select privilege to another application instance.

	Reference	D1226479	Release	1.3p <small>(Printed copy not controlled: verify the version before using)</small>
	Classification level	Public	Pages	177

FMT_SMF.1/SD Specification of Management Functions

FMT_SMF.1.1/SD The TSF shall be capable of performing the following management functions:

Restricting the properties associated to a given package

Registering a new Executable File or application instance in the GP registry.

Removing the specified entries from the GP registry when a DELETE command is received.

Unsetting it as the Default Select application and set this privilege to a new application instance.

Granting the privileges that the authorized entities (MNO, or Application Provider) specifies when a new application instance is installed.

FMT_SMR.1/SD Security roles

FMT_SMR.1.1/SD The TSF shall maintain the roles

Issuer Security Domain

Supplementary Security Domain

Certification Authority Security Domain

Verification Authority Security Domain.

FMT_SMR.1.2/SD The TSF shall be able to associate users with roles.

Secure Channel

FCO_NRO.2/SC Enforced proof of origin

FCO_NRO.2.1/SC The TSF shall enforce the generation of evidence of origin for transmitted **Executable load files** at all times.

FCO_NRO.2.2/SC The TSF shall be able to relate the **identity** of the originator of the information, and the **Executable Load Files** of the information to which the evidence applies.

FCO_NRO.2.3/SC The TSF shall provide a capability to verify the evidence of origin of information to **originator** given **Executable load files**.

	Reference	D1226479	Release	1.3p <small>(Printed copy not controlled: verify the version before using)</small>
	Classification level	Public	Pages	177

FDP_IFC.2/SC Complete information flow control

FDP_IFC.2.1/SC The TSF shall enforce the **Secure Channel Protocol information flow control policy** on

the subjects S.CAD and S.SD, involved in the exchange of messages between the (U)SIM card and the CAD through a potentially unsafe communication channel

the information controlled by this policy is the card content management command, including personalization commands, in the APDUs sent to the card and their associated responses returned to the CAD.

The subjects covered by this policy are those involved in the exchange of messages between the card and the CAD through a potentially unsafe communication channel: o An off-card subject that represents the authorized entities (S.BCV). o Any application with the Security Domain privilege (S.CRD).

The information controlled by this policy is the one contained in the APDU commands sent to the card and their associated responses returned to the CAD or the mobile.

and all operations that cause that information to flow to and from subjects covered by the SFP.

FDP_IFC.2.2/SC The TSF shall ensure that all operations that cause any information in the TOE to flow to and from any subject in the TOE are covered by an information flow control SFP.

FDP_IFF.1/SC Simple security attributes

FDP_IFF.1.1/SC The TSF shall enforce the **Secure Channel Protocol information flow control policy** based on the following types of subject and information security attributes:

Subjects:

S.SD receiving the Card Content Management commands (through APDUs or APIs). This subject can be the ISD, an APSD or a CASD.

S.CAD the off-card entity that communicates with the S.SD.

Information:

load file, in case of application loading;

applications or SD privileges, in case of application installation or registry update;

personalization keys and/or certificates, in case of application or SD personalization.

The subjects have the following security attributes for SCP02 [GP]:

The Challenge is a random number generated by the subject in order to identify the current session.

The Cryptogram is a secret relative to the current smart card session that serves to authenticate the on- and off-card subjects. The

	Reference	D1226479	Release	1.3p <small>(Printed copy not controlled: verify the version before using)</small>
	Classification level	Public	Pages	177

cryptogram is derived from the challenges of both the card and the terminal.

The Key Set is a collection of three keys (Secure Channel Encryption Key (SENC), a Command Message Authentication Code Key (C-MAC) and a Data Encryption Key (DEK)) used to encrypt the Derivation Data in order to generate the session keys. It is identified by a key version number.

-- The Session Keys is a set of keys derived from KeySet and sequence counter to be used to verify the origin and integrity of the received message, and to decrypt their contents. This set is made of the following keys: * Command Message Authentication Code Key (C-MAC session key); * Encryption Key (SENC session key); * Data Encryption Key (DEK session key).

-- The Command Security Level defined for the messages that the card receives through the secure channel. The possible security levels are: NO-SEC (clear text), C-AUTHENTICATED (authentication of the command's issuer), C-MAC (authentication of the issuer and integrity of the command), C-DEC (authentication of the issuer, integrity and confidentiality of the command).

-- The Initial Chaining Vector (ICV) is a value used to compute the MAC value of a message, which relates it to the previous messages of the current session.

The security attributes for SCP80 are:

CPL, CHL giving Information about the length of the received message and the length of the security header in that message;

SPI containing the security level applied to the incoming message, and response (if any), defining properties for message integrity and authentication, replay detection and sequence integrity and confidentiality;

TAR (Target Application Reference), indicating the application which the message is addressed to;

KIC and KID both contain information on the keys (key set number and the key algorithm) to be used when checking the security;

CNTR, a synchronization counter to avoid playing the same message several times;

PCNTR, padding information used only when the message is encrypted; and finally a signature, that can be either a basic CRC of the message or a signature involving keys.

FDP_IFF.1.2/SC The TSF shall permit an information flow between a controlled subject and controlled information via a controlled operation if the following rules hold:

Runtime behavior rules defined by GlobalPlatform for:

loading (Section 9.3.5 of [GP]);

installation (Section 9.3.6 of [GP]);

extradition (Section 9.4.1 of [GP]);

registry update (Section 9.4.2 of [GP]);

SD personalization rules, pull and push models (Section 11 of [GP-UICC]).

	Reference	D1226479	Release	1.3p <small>(Printed copy not controlled: verify the version before using)</small>
	Classification level	Public	Pages	177

Rule IFF-1: The SD may process a RECEIVE (INITIALIZE-UPDATE) operation only if the key set specified in the command exist in the SD and is integer.

Rule IFF-2: The ISD may process a RECEIVE (EXTERNAL-AUTHENTICATE) operation if the following conditions hold:

The cryptogram received from the off-card subject is equal to the cryptogram computed by the Security Domain.

The MAC attached to the message has been generated from the CMAC session key and the current value of the ICV.

Rules IFF-3: The ISD may process a RECEIVE (GET-DATA) operation if the following condition holds: If the command security level is at least C-MAC, the MAC attached to the message has been generated from the command using the C-MAC session key and the current value of the ICV.

Rules IFF-4: The ISD may process a RECEIVE (M) operation for any other command M different from the ones cited in the rules above if the following conditions hold:

The current security level is at least AUTHENTICATED.

If the command security level is at least C-MAC, the MAC attached to the message has been generated from the clear-text command using the C-MAC session key and the current value of the ICV.

FDP_IFF.1.3/SC The TSF shall enforce the **no additional information flow control SFP rules**.

FDP_IFF.1.4/SC The TSF shall explicitly authorise an information flow based on the following rules: **no additional information flow control SFP rules**.

FDP_IFF.1.5/SC The TSF shall explicitly deny an information flow based on the following rules:

When none of the conditions listed in the element FDP_IFF.1.4 of this component hold and at least one of those listed in the element FDP_IFF.1.2 does not hold.

FIA_UID.1/SC Timing of identification

FIA_UID.1.1/SC The TSF shall allow

application selection;

initializing a secure channel with the card;

requesting data that identifies the card or the Card Issuer;

on behalf of the user to be performed before the user is identified.

	Reference	D1226479	Release	1.3p <small>(Printed copy not controlled: verify the version before using)</small>
	Classification level	Public	Pages	177

FIA_UID.1.2/SC The TSF shall require each user to be successfully identified before allowing any other TSF-mediated actions on behalf of that user.

Application note:

The GlobalPlatform TSF mediated actions listed in [GP] such as selecting an application, requesting data, initializing, etc.

FIA_UAU.1/SC Timing of authentication

FIA_UAU.1.1/SC The TSF shall allow **the TSF mediated actions listed in FIA_UID.1/SC** on behalf of the user to be performed before the user is authenticated.

FIA_UAU.1.2/SC The TSF shall require each user to be successfully authenticated before allowing any other TSF-mediated actions on behalf of that user.

FIA_UAU.4/SC Single-use authentication mechanisms

FIA_UAU.4.1/SC The TSF shall prevent reuse of authentication data related to **the authentication mechanism used to open a secure communication channel with the card.**

FMT_MSA.1/SC Management of security attributes

FMT_MSA.1.1/SC The TSF shall enforce the **Secure Channel Protocol (SCP) information flow control policy** to restrict the ability to **modify** the security attributes **(1) key set, Static keys, Command security Level, Secure channel protocol of a security domain (2) Session Keys, Sequence Counter and ICV of a session (for SCP02) (3) SPI, TAR,CNTR, PCNTR, signature (for SCP80) to (1 & 2 & 3) the actor associated with the security domain:**

**The Mobile Network Operator for ISD,
The application Provider for SSD,
The CA for CASD.**

Application note:

The authorized identified roles could be the card issuer (off-card) or a SD (on-card).

	Reference	D1226479	Release	1.3p <small>(Printed copy not controlled: verify the version before using)</small>
	Classification level	Public	Pages	177

FMT_MSA.3/SC Static attribute initialisation

FMT_MSA.3.1/SC The TSF shall enforce the **Secure Channel Protocol (SCP) information flow control policy** to provide **restrictive** default values for security attributes that are used to enforce the SFP.

FMT_MSA.3.2/SC The TSF shall allow the **authorized entities (MNO, or Application Provider)** to specify alternative initial values to override the default values when an object or information is created.

Refinement:

Alternative initial values shall be at least as restrictive as the default values defined in FMT_MSA.3.1.

FMT_SMF.1/SC Specification of Management Functions

FMT_SMF.1.1/SC The TSF shall be capable of performing the following management functions:

Management functions specified in GlobalPlatform specifications [GP]:

loading (Section 9.3.5 of [GP]);

installation (Section 9.3.6 of [GP]);

extradition (Section 9.4.1 of [GP]);

registry update (Section 9.4.2 of [GP]);

SD personalization rules, pull and push models (Section 11 of [GP-UICC]).

The management functions are:

(for SCP02)

Generating a new card challenge during the set up of a Secure Channel.

Generating the session keys for the Secure Channel from the specified static key set and its associated Sequence Counter.

Generating the card cryptogram from the host and card challenges and the session keys.

Increasing by one the Sequence Counter associated to the specified Key Set upon successful opening a Secure Channel.

Setting the security level of the Secure Channel as the authenticated authorized entities (MNO, or Application Provider) had specified during its set up.

Updating the current value of the ICV upon reception of a new message through the Secure Channel.

On request of the Issuer or authorized application provider, loading or replacing the static keys that the associated Security Domain uses to open a Secure Channel.

(For SCP80):

	Reference	D1226479	Release	1.3p <small>(Printed copy not controlled: verify the version before using)</small>
	Classification level	Public	Pages	177

modifying parameter values (CPL, CHL, SPI, Kic, Kid, TAR, CNTR, PCNTR, signature),

Setting the security level of the Secure Channel as the authenticated authorized entities (MNO, or Application Provider) had specified during its set up,

On request of the Issuer or authorized application provider, loading or replacing the static keys that the associated Security Domain uses to open a Secure Channel.

Application note:

All management functions related to SCP02 secure channel shall be relevant.

FTP_ITC.1/SC Inter-TSF trusted channel

FTP_ITC.1.1/SC The TSF shall provide a communication channel between itself and another trusted IT product that is logically distinct from other communication channels and provides assured identification of its end points and protection of the channel data from modification or disclosure.

FTP_ITC.1.2/SC The TSF shall permit **another trusted IT product** to initiate communication via the trusted channel.

FTP_ITC.1.3/SC The TSF shall initiate communication via the trusted channel for **all card management functions:**

- loading or deleting an Executable Load file;**
- installing or removing an application instance;**
- extrading an Executable Load file or an application instance;**
- registry update;**
- Loading or removing a KeySet;**
- SD personalization;**
- changing the Application Life Cycle or card Life Cycle;**

6.1.2 Java Card System Protection Profile - Open Configuration

This section states the security functional requirements for the Java Card System - Open configuration. For readability and for compatibility with the original Java Card System Protection Profile Collection - Standard 2.2 Configuration [PP/0305], requirements are arranged into groups. All the groups defined in the table below apply to this Protection Profile.

	Reference	D1226479	Release	1.3p <small>(Printed copy not controlled: verify the version before using)</small>
	Classification level	Public	Pages	177

Group	Description
Core with Logical Channels (<i>CoreG_LC</i>)	The CoreG_LC contains the requirements concerning the runtime environment of the Java Card System implementing logical channels. This includes the firewall policy and the requirements related to the Java Card API. Logical channels are a Java Card specification version 2.2 feature. This group is the union of requirements from the Core (<i>CoreG</i>) and the Logical channels (<i>LCG</i>) groups defined in [PP/0305] (cf. Java Card System Protection Profile Collection [PP JCS]).
Installation (<i>InstG</i>)	The InstG contains the security requirements concerning the installation of post-issuance applications. It does not address card management issues in the broad sense, but only those security aspects of the installation procedure that are related to applet execution.
Applet deletion (<i>ADELG</i>)	The ADELG contains the security requirements for erasing installed applets from the card, a feature introduced in Java Card specification version 2.2.
Remote Method Invocation (RMI)	The RMIG contains the security requirements for the remote method invocation feature, which provides a new protocol of communication between the terminal and the applets. This was introduced in Java Card specification version 2.2.
Object deletion (<i>ODELG</i>)	The ODELG contains the security requirements for the object deletion capability. This provides a safe memory recovering mechanism. This is a Java Card specification version 2.2 feature.
Secure carrier (<i>CarG</i>)	The CarG group contains minimal requirements for secure downloading of applications on the card. This group contains the security requirements for preventing, in those configurations that do not support on-card static or dynamic bytecode verification, the installation of a package that has not been bytecode verified, or that has been modified after bytecode verification.

Subjects are active components of the TOE that (essentially) act on the behalf of users. The users of the TOE include people or institutions (like the applet developer, the card issuer, the verification authority), hardware (like the CAD where the card is inserted or the PCD) and software components (like the application packages installed on the card). Some of the users may just be aliases for other users. For instance, the verification authority in charge of the bytecode verification of the applications may be just an alias for the card issuer.

Subjects (prefixed with an "S") are described in the following table:

	Reference	D1226479	Release	1.3p <small>(Printed copy not controlled: verify the version before using)</small>
	Classification level	Public	Pages	177

Subject	Description
S.ADEL	The applet deletion manager which also acts on behalf of the card issuer. It may be an applet ([JCRE222], §11), but its role asks anyway for a specific treatment from the security viewpoint. This subject is unique and is involved in the ADEL security policy defined in §7.1.3.1.
S.APPLLET	Any applet instance.
S.BCV	The bytecode verifier (BCV), which acts on behalf of the verification authority who is in charge of the bytecode verification of the packages. This subject is involved in the PACKAGE LOADING security policy defined in §7.1.7.
S.CAD	The CAD represents the actor that requests, by issuing commands to the card, for RMI services. It also plays the role of the off-card entity that communicates with the S.INSTALLER.
S.INSTALLER	The installer is the on-card entity which acts on behalf of the card issuer. This subject is involved in the loading of packages and installation of applets.
S.JCRE	The runtime environment under which Java programs in a smart card are executed.
S.JCVM	The bytecode interpreter that enforces the firewall at runtime.
S.LOCAL	Operand stack of a JCVM frame, or local variable of a JCVM frame containing an object or an array of references.
S.MEMBER	Any object's field, static field or array position.
S.PACKAGE	A package is a namespace within the Java programming language that may contain classes and interfaces, and in the context of Java Card technology, it defines either a user library, or one or several applets.

Objects (prefixed with an "O") are described in the following table:

	Reference D1226479	Release 1.3p <small>(Printed copy not controlled: verify the version before using)</small>
	Classification level Public	Pages 177

Object	Description
O.APPLET	Any installed applet, its code and data.
O.CODE_PKG	The code of a package, including all linking information. On the Java Card platform, a package is the installation unit.
O.JAVAOBJECT	Java class instance or array. It should be noticed that KEYS, PIN, arrays and applet instances are specific objects in the Java programming language.
O.REMOTE_MTHD	A method of a remote interface.
O.REMOTE_OBJ	A remote object is an instance of a class that implements one (or more) remote interfaces. A remote interface is one that extends, directly or indirectly, the interface java.rmi.Remote ([JCAPI222]).
O.RMI_SERVICE	These are instances of the class javacardx.rmi.RMIService. They are the objects that actually process the RMI services.
O.ROR	A remote object reference. It provides information concerning: (i) the identification of a remote object and (ii) the Implementation class of the object or the interfaces implemented by the class of the object. This is the object's information to which the CAD can access.

Information (prefixed with an "I") is described in the following table:

Information	Description
I.APDU	Any APDU sent to or from the card through the communication channel.
I.DATA	JCVM Reference Data: objectref addresses of APDU buffer, JCRE-owned instances of APDU class and byte array for install method.
I.RORD	Remote object reference descriptors which provide information concerning: (i) the identification of the remote object and (ii) the implementation class of the object or the interfaces implemented by the class of the object. The descriptor is the only object's information to which the CAD can access.

Security attributes linked to these subjects, objects and information are described in the following table with their values:

	Reference	D1226479	Release	1.3p <small>(Printed copy not controlled: verify the version before using)</small>
	Classification level	Public	Pages	177

Security attribute	Description/Value
Active Applets	The set of the active applets' AIDs. An active applet is an applet that is selected on at least one of the logical channels.
Applet Selection Status	"Selected" or "Deselected".
Applet's version number	The version number of an applet (package) indicated in the export file.
Class	Identifies the implementation class of the remote object.
Context	Package AID or "Java Card RE".
Currently Active Context	Package AID or "Java Card RE".
Dependent package AID	Allows the retrieval of the Package AID and Applet's version number ([JCVM222], §4.5.2).
ExportedInfo	Boolean (indicates whether the remote object is exportable or not).
Identifier	The Identifier of a remote object or method is a number that uniquely identifies the remote object or method, respectively.
LC Selection Status	Multiselectable, Non-multiselectable or "None".
LifeTime	CLEAR_ON_DESELECT or PERSISTENT (*).
Owner	The Owner of an object is either the applet instance that created the object or the package (library) where it has been defined (these latter objects can only be arrays that initialize static fields of the package). The owner of a remote object is the applet instance that created the object.
Package AID	The AID of each package indicated in the export file.
Registered Applets	The set of AID of the applet instances registered on the card.
Remote	An object is Remote if it is an instance of a class that directly or indirectly implements the interface java.rmi.Remote.
Resident Packages	The set of AIDs of the packages already loaded on the card.
Returned References	The set of remote object references that have been sent to the CAD during the applet selection session. This attribute is implementation dependent.
Selected Applet Context	Package AID or "None".
Sharing	Standards, SIO, Java Card RE entry point or global array.

	Reference D1226479	Release 1.3p <small>(Printed copy not controlled: verify the version before using)</small>
	Classification level Public	Pages 177

Security attribute	Description/Value
Static References	Static fields of a package may contain references to objects. The Static References attribute records those references.

(*) Transient objects of type CLEAR_ON_RESET behave like persistent objects in that they can be accessed only when the Currently Active Context is the object's context.

Operations (prefixed with "OP") are described in the following table. Each operation has parameters given between brackets, among which there is the "accessed object", the first one, when applicable. Parameters may be seen as security attributes that are under the control of the subject performing the operation.

	Reference	D1226479	Release	1.3p <small>(Printed copy not controlled: verify the version before using)</small>
	Classification level	Public	Pages	177

Operation	Description
OP.ARRAY_ACCESS(O.JAVAOBJECT, field)	Read/Write an array component.
OP.CREATE(Sharing, LifeTime) (*)	Creation of an object (new or makeTransient call).
OP.DELETE_APPLET(O.APPLET,...)	Delete an installed applet and its objects, either logically or physically.
OP.DELETE_PCKG(O.CODE_PKG,...)	Delete a package, either logically or physically.
OP.DELETE_PCKG_APPLET(O.CODE_PKG,...)	Delete a package and its installed applets, either logically or physically.
OP.GET_ROR(O.APPLET,...)	Retrieves the initial remote object reference of a RMI based applet. This reference is the seed which the CAD client application needs to begin remote method invocations.
OP.INSTANCE_FIELD(O.JAVAOBJECT, field)	Read/Write a field of an instance of a class in the Java programming language.
OP.INVK_VIRTUAL(O.JAVAOBJECT, method, arg1,...)	Invoke a virtual method (either on a class instance or an array object).
OP.INVK_INTERFACE(O.JAVAOBJECT, method, arg1,...)	Invoke an interface method.
OP.INVOKE(O.RMI_SERVICE,...)	Requests a remote method invocation on the remote object.
OP.JAVA(...)	Any access in the sense of [JCRE222], §6.2.8. It stands for one of the operations OP.ARRAY_ACCESS, OP.INSTANCE_FIELD, OP.INVK_VIRTUAL, OP.INVK_INTERFACE, OP.THROW, OP.TYPE_ACCESS.
OP.PUT(S1,S2,I)	Transfer a piece of information I from S1 to S2.
OP.RET_RORD(S.JCRE,S.CAD,I.RORD)	Send a remote object reference descriptor to the CAD.
OP.THROW(O.JAVAOBJECT)	Throwing of an object (athrow, see [JCRE222], §6.2.8.7).
OP.TYPE_ACCESS(O.JAVAOBJECT, class)	Invoke checkcast or instanceof on an object in order to access to classes (standard or shareable interfaces objects).

	Reference D1226479	Release 1.3p <small>(Printed copy not controlled: verify the version before using)</small>
	Classification level Public	Pages 177

(*) For this operation, there is no accessed object. This rule enforces that shareable transient objects are not allowed. For instance, during the creation of an object, the JavaCardClass attribute's value is chosen by the creator.

6.1.2.1 CoreG_LC Security Functional Requirements

This group is focused on the main security policy of the Java Card System, known as the firewall.

Firewall Policy

FDP_ACC.2/FIREWALL Complete access control

FDP_ACC.2.1/FIREWALL The TSF shall enforce the **FIREWALL access control SFP** on **S.PACKAGE, S.JCRE, S.JCVM, O.JAVAOBJECT** and all operations among subjects and objects covered by the SFP.

Refinement:

The operations involved in the policy are:

- OP.CREATE,
- OP.INVK_INTERFACE,
- OP.INVK_VIRTUAL,
- OP.JAVA,
- OP.THROW,
- OP.TYPE_ACCESS.

FDP_ACC.2.2/FIREWALL The TSF shall ensure that all operations between any subject controlled by the TSF and any object controlled by the TSF are covered by an access control SFP.

Application note:

It should be noticed that accessing array's components of a static array, and more generally fields and methods of static objects, is an access to the corresponding O.JAVAOBJECT.

	Reference	D1226479	Release	1.3p <small>(Printed copy not controlled: verify the version before using)</small>
	Classification level	Public	Pages	177

FDP_ACF.1/FIREWALL Security attribute based access control

FDP_ACF.1.1/FIREWALL The TSF shall enforce the **FIREWALL** access control **SFP** to objects based on the following:

Subject/Object	Security attributes
S.PACKAGE	LC Selection Status
S.JCVM	Active Applets, Currently Active Context
S.JCRE	Selected Applet Context
O.JAVAOBJECT	Sharing, Context, LifeTime

FDP_ACF.1.2/FIREWALL The TSF shall enforce the following rules to determine if an operation among controlled subjects and controlled objects is allowed:

R.JAVA.1 ([JCRE222], §6.2.8): S.PACKAGE may freely perform OP.ARRAY_ACCESS, OP.INSTANCE_FIELD, OP.INVK_VIRTUAL, OP.INVK_INTERFACE, OP.THROW or OP.TYPE_ACCESS upon any O.JAVAOBJECT whose Sharing attribute has value "JCRE entry point" or "global array".

R.JAVA.2 ([JCRE222], §6.2.8): S.PACKAGE may freely perform OP.ARRAY_ACCESS, OP.INSTANCE_FIELD, OP.INVK_VIRTUAL, OP.INVK_INTERFACE or OP.THROW upon any O.JAVAOBJECT whose Sharing attribute has value "Standard" and whose Lifetime attribute has value "PERSISTENT" only if O.JAVAOBJECT's Context attribute has the same value as the active context.

R.JAVA.3 ([JCRE222], §6.2.8.10): S.PACKAGE may perform OP.TYPE_ACCESS upon an O.JAVAOBJECT whose Sharing attribute has value "SIO" only if O.JAVAOBJECT is being cast into (checkcast) or is being verified as being an instance of (instanceof) an interface that extends the Shareable interface.

R.JAVA.4 ([JCRE222], §6.2.8.6): S.PACKAGE may perform OP.INVK_INTERFACE upon an O.JAVAOBJECT whose Sharing attribute has the value "SIO", and whose Context attribute has the value "Package AID", only if the invoked interface method extends the Shareable interface and one of the following conditions applies:

- a) The value of the attribute Selection Status of the package whose AID is "Package AID" is "Multiselectable",
- b) The value of the attribute Selection Status of the package whose AID is "Package AID" is "Non-multiselectable", and either "Package AID" is the value of the currently selected applet or otherwise "Package AID" does not occur in the attribute Active Applets.

R.JAVA.5: S.PACKAGE may perform OP.CREATE only if the value of the Sharing parameter is "Standard".

	Reference	D1226479	Release	1.3p <small>(Printed copy not controlled: verify the version before using)</small>
	Classification level	Public	Pages	177

FDP_ACF.1.3/FIREWALL The TSF shall explicitly authorise access of subjects to objects based on the following additional rules:

- 1) The subject S.JCRE can freely perform OP.JAVA("") and OP.CREATE, with the exception given in FDP_ACF.1.4/FIREWALL, provided it is the Currently Active Context.**
- 2) The only means that the subject S.JCVM shall provide for an application to execute native code is the invocation of a Java Card API method (through OP.INVK_INTERFACE or OP.INVK_VIRTUAL).**

FDP_ACF.1.4/FIREWALL The TSF shall explicitly deny access of subjects to objects based on the following additional rules:

- 1) Any subject with OP.JAVA upon an O.JAVAOBJECT whose LifeTime attribute has value "CLEAR_ON_DESELECT" if O.JAVAOBJECT's Context attribute is not the same as the Selected Applet Context.**
- 2) Any subject attempting to create an object by the means of OP.CREATE and a "CLEAR_ON_DESELECT" LifeTime parameter if the active context is not the same as the Selected Applet Context.**

Application note:

FDP_ACF.1.4/FIREWALL:

The deletion of applets may render some O.JAVAOBJECT inaccessible, and the Java Card RE may be in charge of this aspect. This can be done, for instance, by ensuring that references to objects belonging to a deleted application are considered as a null reference. Such a mechanism is implementation-dependent.

In the case of an array type, fields are components of the array ([JVM], §2.14, §2.7.7), as well as the length; the only methods of an array object are those inherited from the Object class.

The Sharing attribute defines four categories of objects:

- Standard ones, whose both fields and methods are under the firewall policy,
- Shareable interface Objects (SIO), which provide a secure mechanism for inter-applet communication,
- JCRE entry points (Temporary or Permanent), who have freely accessible methods but protected fields,
- Global arrays, having both unprotected fields (including components; refer to JavaCardClass discussion above) and methods.

When a new object is created, it is associated with the Currently Active Context. But the object is owned by the applet instance within the Currently Active Context when the object is instantiated ([JCRE222], §6.1.3). An object is owned by an applet instance, by the JCRE or by the package library where it has been defined (these latter objects can only be arrays that initialize static fields of packages).

	Reference D1226479	Release 1.3p <small>(Printed copy not controlled: verify the version before using)</small>
	Classification level Public	Pages 177

([JCRE222], Glossary) Selected Applet Context. The Java Card RE keeps track of the currently selected Java Card applet. Upon receiving a SELECT command with this applet's AID, the Java Card RE makes this applet the Selected Applet Context. The Java Card RE sends all APDU commands to the Selected Applet Context.

While the expression "Selected Applet Context" refers to a specific installed applet, the relevant aspect to the policy is the context (package AID) of the selected applet. In this policy, the "Selected Applet Context" is the AID of the selected package.

([JCRE222], §6.1.2.1) At any point in time, there is only one active context within the Java Card VM (this is called the Currently Active Context).

It should be noticed that the invocation of static methods (or access to a static field) is not considered by this policy, as there are no firewall rules. They have no effect on the active context as well and the "acting package" is not the one to which the static method belongs to in this case.

It should be noticed that the Java Card platform, version 2.2.x and version 3 Classic Edition, introduces the possibility for an applet instance to be selected on multiple logical channels at the same time, or accepting other applets belonging to the same package being selected simultaneously. These applets are referred to as multiselectable applets. Applets that belong to a same package are either all multiselectable or not ([JCV222], §2.2.5). Therefore, the selection mode can be regarded as an attribute of packages. No selection mode is defined for a library package.

An applet instance will be considered an active applet instance if it is currently selected in at least one logical channel. An applet instance is the currently selected applet instance only if it is processing the current command. There can only be one currently selected applet instance at a given time. ([JCRE222], §4).

FDP_IFC.1/JCVM Subset information flow control

FDP_IFC.1.1/JCVM The TSF shall enforce the **JCVM information flow control SFP** on **S.JCVM, S.LOCAL, S.MEMBER, I.DATA and OP.PUT(S1, S2, I)**.

Application note:

It should be noticed that references of temporary Java Card RE entry points, which cannot be stored in class variables, instance variables or array components, are transferred from the internal memory of the Java Card RE (TSF data) to some stack through specific APIs (Java Card RE owned exceptions) or Java Card RE invoked methods (such as the process(APDU apdu)); these are causes of OP.PUT(S1,S2,I) operations as well.

	Reference	D1226479	Release	1.3p <small>(Printed copy not controlled: verify the version before using)</small>
	Classification level	Public	Pages	177

FDP_IFF.1/JCVM Simple security attributes

FDP_IFF.1.1/JCVM The TSF shall enforce the **JCVM information flow control SFP** based on the following types of subject and information security attributes:

Subjects	Security attributes
S.JCVM	Currently Active Context

FDP_IFF.1.2/JCVM The TSF shall permit an information flow between a controlled subject and controlled information via a controlled operation if the following rules hold:

An operation OP.PUT(S1, S.MEMBER, I.DATA) is allowed if and only if the Currently Active Context is "Java Card RE"; other OP.PUT operations are allowed regardless of the Currently Active Context's value.

FDP_IFF.1.3/JCVM The TSF shall enforce the **[No additional rules]**.

FDP_IFF.1.4/JCVM The TSF shall explicitly authorise an information flow based on the following rules: **[No additional rules]**.

FDP_IFF.1.5/JCVM The TSF shall explicitly deny an information flow based on the following rules: **[No additional rules]**.

Application note:

The storage of temporary Java Card RE-owned objects references is runtime-enforced ([JCRE222], §6.2.8.1-3).

It should be noticed that this policy essentially applies to the execution of bytecode. Native methods, the Java Card RE itself and possibly some API methods can be granted specific rights or limitations through the FDP_IFF.1.3/JCVM to FDP_IFF.1.5/JCVM elements. The way the Java Card virtual machine manages the transfer of values on the stack and local variables (returned values, uncaught exceptions) from and to internal registers is implementation-dependent. For instance, a returned reference, depending on the implementation of the stack frame, may transit through an internal register prior to being pushed on the stack of the invoker. The returned bytecode would cause more than one OP.PUT operation under this scheme.

	Reference	D1226479	Release	1.3p <small>(Printed copy not controlled: verify the version before using)</small>
	Classification level	Public	Pages	177

FDP_RIP.1/OBJECTS Subset residual information protection

FDP_RIP.1.1/OBJECTS The TSF shall ensure that any previous information content of a resource is made unavailable upon the **allocation of the resource to** the following objects: **class instances and arrays**.

Application note:

The semantics of the Java programming language requires for any object field and array position to be initialized with default values when the resource is allocated [JVM], §2.5.1.

FMT_MSA.1/JCRE Management of security attributes

FMT_MSA.1.1/JCRE The TSF shall enforce the **FIREWALL access control SFP** to restrict the ability to **modify** the security attributes **Selected Applet Context to the Java Card RE**.

Application note:

The modification of the Selected Applet Context should be performed in accordance with the rules given in [JCRE222], §4 and [JCVM222], §3.4.

FMT_MSA.1/JCVM Management of security attributes

FMT_MSA.1.1/JCVM The TSF shall enforce the **FIREWALL access control SFP and the JCVM information flow control SFP** to restrict the ability to **modify** the security attributes **Currently Active Context and Active Applets to the Java Card VM (S.JCVM)**.

Application note:

The modification of the Currently Active Context should be performed in accordance with the rules given in [JCRE222], §4 and [JCVM222], §3.4.

	Reference	D1226479	Release	1.3p <small>(Printed copy not controlled: verify the version before using)</small>
	Classification level	Public	Pages	177

FMT_MSA.2/FIREWALL_JCVM Secure security attributes

FMT_MSA.2.1/FIREWALL_JCVM The TSF shall ensure that only secure values are accepted for **all the security attributes of subjects and objects defined in the FIREWALL access control SFP and the JCVM information flow control SFP.**

Application note:

The following rules are given as examples only. For instance, the last two rules are motivated by the fact that the Java Card API defines only transient arrays factory methods. Future versions may allow the creation of transient objects belonging to arbitrary classes; such evolution will naturally change the range of "secure values" for this component.

The Context attribute of an O.JAVAOBJECT must correspond to that of an installed applet or be "Java Card RE".

An O.JAVAOBJECT whose Sharing attribute is a Java Card RE entry point or a global array necessarily has "Java Card RE" as the value for its Context security attribute.

An O.JAVAOBJECT whose Sharing attribute value is a global array necessarily has "array of primitive type" as a JavaCardClass security attribute's value.

Any O.JAVAOBJECT whose Sharing attribute value is not "Standard" has a PERSISTENT-LifeTime attribute's value.

Any O.JAVAOBJECT whose LifeTime attribute value is not PERSISTENT has an array type as JavaCardClass attribute's value.

FMT_MSA.3/FIREWALL Static attribute initialisation

FMT_MSA.3.1/FIREWALL The TSF shall enforce the **FIREWALL access control SFP** to provide **restrictive** default values for security attributes that are used to enforce the SFP.

FMT_MSA.3.2/FIREWALL [Editorially Refined] The TSF shall not allow **any role** to specify alternative initial values to override the default values when an object or information is created.

Application note:

FMT_MSA.3.1/FIREWALL

Objects' security attributes of the access control policy are created and initialized at the creation of the object or the subject. Afterwards, these attributes are no longer mutable (FMT_MSA.1/JCRE). At the creation of an object (OP.CREATE), the newly created object, assuming that the FIREWALL access control SFP permits the operation, gets its Lifetime and Sharing attributes from the parameters of the operation; on the contrary, its Context attribute has a default value, which is its creator's Context attribute and AID respectively ([JCRE222], §6.1.3). There is one default value for the Selected Applet Context that is the default applet identifier's Context, and one default value for the Currently Active Context that is "Java Card RE".

	Reference	D1226479	Release	1.3p <small>(Printed copy not controlled: verify the version before using)</small>
	Classification level	Public	Pages	177

The knowledge of which reference corresponds to a temporary entry point object or a global array and which does not is solely available to the Java Card RE (and the Java Card virtual machine).

FMT_MSA.3.2/FIREWALL

The intent is that none of the identified roles has privileges with regard to the default values of the security attributes. It should be noticed that creation of objects is an operation controlled by the FIREWALL access control SFP. The operation shall fail anyway if the created object would have had security attributes whose value violates FMT_MSA.2.1/FIREWALL_JCVM.

FMT_MSA.3/JCVM Static attribute initialisation

FMT_MSA.3.1/JCVM The TSF shall enforce the **JCVM information flow control SFP** to provide **restrictive** default values for security attributes that are used to enforce the SFP.

FMT_MSA.3.2/JCVM [Editorially Refined] The TSF shall not allow **any role** to specify alternative initial values to override the default values when an object or information is created.

FMT_SMF.1 Specification of Management Functions

FMT_SMF.1.1 The TSF shall be capable of performing the following management functions:
modify the Currently Active Context, the Selected Applet Context and the Active Applets.

FMT_SMR.1 Security roles

FMT_SMR.1.1 The TSF shall maintain the roles:
Java Card RE (JCRE),
Java Card VM (JCVM).

FMT_SMR.1.2 The TSF shall be able to associate users with roles.

Application Programming Interface

The following SFRs are related to the Java Card API.

The whole set of cryptographic algorithms is generally not implemented because of limited memory resources and/or limitations due to exportation. Therefore, the following requirements only apply to the implemented subset.

	Reference	D1226479	Release	1.3p <small>(Printed copy not controlled: verify the version before using)</small>
	Classification level	Public	Pages	177

It should be noticed that the execution of the additional native code is not within the TSF. Nevertheless, access to API native methods from the Java Card System is controlled by TSF because there is no difference between native and interpreted methods in their interface or invocation mechanism.

FCS_CKM.1/DES Cryptographic key generation

FCS_CKM.1.1/DES The TSF shall generate cryptographic keys in accordance with a specified cryptographic key generation algorithm **TDES Key generation** and specified cryptographic key sizes **112 bits for TDES 2 keys, 168 bits for TDES 3 keys** that meet the following: **none (random numbers generation)**.

Application note:

The keys can be generated and diversified in accordance with [JCAPI222] standard in classes KeyBuilder.

FCS_CKM.1/AES Cryptographic key generation

FCS_CKM.1.1/AES The TSF shall generate cryptographic keys in accordance with a specified cryptographic key generation algorithm **AES Key generation** and specified cryptographic key sizes **128 bits for AES key** that meet the following: **none (random numbers generation)**.

Application note:

The keys can be generated and diversified in accordance with [JCAPI222] standard in classes KeyBuilder.

FCS_CKM.1/RSA Cryptographic key generation

FCS_CKM.1.1/RSA The TSF shall generate cryptographic keys in accordance with a specified cryptographic key generation algorithm [**see application note**] and specified cryptographic key sizes [**1536 to 2048 bits**]with **CRT** that meet the following: [**see application note**].

Application note:

The keys can be generated and diversified in accordance with [JCAPI222] standard in classes KeyBuilder and KeyPair (at least Session key generation).

	Reference	D1226479	Release	1.3p <small>(Printed copy not controlled: verify the version before using)</small>
	Classification level	Public	Pages	177

FCS_CKM.2/DES Cryptographic key distribution

FCS_CKM.2.1/DES The TSF shall distribute cryptographic keys in accordance with a specified cryptographic key distribution method (**see application note**) that meets the following: (**see application note**).

Application note:

Command SetKEY that meets [JCAPI222] standard.

FCS_CKM.2/AES Cryptographic key distribution

FCS_CKM.2.1/AES The TSF shall distribute cryptographic keys in accordance with a specified cryptographic key distribution method (**see application note**) that meets the following: (**see application note**).

Application note:

Command SetKEY that meets [JCAPI222] standard.

FCS_CKM.2/RSA Cryptographic key distribution

FCS_CKM.2.1/RSA The TSF shall distribute cryptographic keys in accordance with a specified cryptographic key distribution method (**see application note**) that meets the following: (**see application note**).

Application note:

Command SetKEY that meets [JCAPI222] standard.

FCS_CKM.3/DES Cryptographic key access

FCS_CKM.3.1/DES The TSF shall perform (**see application note**) in accordance with a specified cryptographic key access method (**see application note**) that meets the following: (**see application note**).

Application note:

The keys can be accessed in accordance with [JCAPI222] standard in class Key.

	Reference	D1226479	Release	1.3p <small>(Printed copy not controlled: verify the version before using)</small>
	Classification level	Public	Pages	177

FCS_CKM.3/AES Cryptographic key access

FCS_CKM.3.1/AES The TSF shall perform (**see application note**) in accordance with a specified cryptographic key access method (**see application note**) that meets the following: (**see application note**).

Application note:

The keys can be accessed in accordance with [JCAPI222] standard in class Key.

FCS_CKM.3/RSA Cryptographic key access

FCS_CKM.3.1/RSA The TSF shall perform (**see application note**) in accordance with a specified cryptographic key access method (**see application note**) that meets the following: (**see application note**).

Application note:

The keys can be accessed in accordance with [JCAPI222] standard in class Key.

FCS_CKM.4 Cryptographic key destruction

FCS_CKM.4.1 The TSF shall destroy cryptographic keys in accordance with a specified cryptographic key destruction method (**see application note**) that meets the following: (**see application note**).

Application note:

The keys are reset as specified in [JCAPI222] Key class, with the method clearKey(). Any access to a cleared key for ciphering or signing shall throw an exception.

FCS_COP.1/DES_CIPHER Cryptographic operation

FCS_COP.1.1/DES_CIPHER The TSF shall perform [**encryption and decryption of applet instance's data**] in accordance with a specified cryptographic algorithm [**Triple DES either in CBC or ECB mode and with padding scheme (NOPAD,ISO9797 or PKCS#5)**] and cryptographic key sizes [**112 or 168 bits**] that meet the following: [**FIPS PUB 46-3, FIPS PUB 81, ISO 9797, according to JCAPI222**].

Application note:

The TOE shall provide a subset of cryptographic operations defined in [JCAPI222] (see javacardx.crypto.Cipher and javacardx.security packages).

	Reference	D1226479	Release	1.3p <small>(Printed copy not controlled: verify the version before using)</small>
	Classification level	Public	Pages	177

FCS_COP.1/DES_MAC_COMP Cryptographic operation

FCS_COP.1.1/DES_MAC_COMP The TSF shall perform **[MAC generation or verification of applet instance's data]** in accordance with a specified cryptographic algorithm **[Triple DES in CBC mode and with or without padding generating MAC on 4-bytes or 8-bytes]** and cryptographic key sizes **[112 or 168 bits]** that meet the following: **[FIPS PUB 46-3, FIPS PUB 81, ISO 9797, according to JCAPI222]**.

Application note:

The TOE shall provide a subset of cryptographic operations defined in [JCAPI222] (see javacardx.crypto.Cipher and javacardx.security packages).

FCS_COP.1/AES_CIPHER Cryptographic operation

FCS_COP.1.1/AES_CIPHER The TSF shall perform **[encryption and decryption of applet instance's data]** in accordance with a specified cryptographic algorithm **[AES (128 bits) either in CBC or ECB mode without padding]** and cryptographic key sizes **[128 bits]** that meet the following: **[FIPS PUB 197, FIPS PUB 81, ISO 9797, according to JCAPI222]**.

Application note:

The TOE shall provide a subset of cryptographic operations defined in [JCAPI222] (see javacardx.crypto.Cipher and javacardx.security packages).

FCS_COP.1/AES_MAC_COMP Cryptographic operation

FCS_COP.1.1/AES_MAC_COMP The TSF shall perform **[MAC generation or verification of applet instance's data]** in accordance with a specified cryptographic algorithm **[AES (128bits) in CBC mode and with or without padding generating MAC on 4-bytes or 8-bytes]** and cryptographic key sizes **[112 or 168 bits]** that meet the following: **[FIPS PUB 197, FIPS PUB 81, ISO 9797, according to JCAPI222]**.

Application note:

The TOE shall provide a subset of cryptographic operations defined in [JCAPI222] (see javacardx.crypto.Cipher and javacardx.security packages).

	Reference	D1226479	Release	1.3p <small>(Printed copy not controlled: verify the version before using)</small>
	Classification level	Public	Pages	177

FCS_COP.1/RSA_SIGN Cryptographic operation

FCS_COP.1.1/RSA_SIGN The TSF shall perform [**signature generation or verification of applet instance's data**] in accordance with a specified cryptographic algorithm [**RSA with CRT in mode ISO 14888 with padding scheme (ISO9796 or PKCS #1)**] and cryptographic key sizes [**1536 to 2048 bits**] that meet the following: [**PKCS #1 Version 2.1**].

Application note:

The TOE shall provide a subset of cryptographic operations defined in [JCAPI222] (see javacardx.crypto.Cipher and javacardx.security packages).

FCS_COP.1/RSA_CIPHER Cryptographic operation

FCS_COP.1.1/RSA_CIPHER The TSF shall perform [**encryption or decryption of applet instance's data**] in accordance with a specified cryptographic algorithm [**RSA with CRT**] and cryptographic key sizes [**1536 to 2048 bits**] that meet the following: [**PKCS #1 Version 2.1**].

Application note:

The TOE shall provide a subset of cryptographic operations defined in [JCAPI22] (see javacardx.crypto.Cipher and javacardx.security packages).

FCS_COP.1/HMAC Cryptographic operation

FCS_COP.1.1/HMAC The TSF shall perform [**computation of a hash value for applet instance's data**] in accordance with a specified cryptographic algorithm [**HMAC, HMAC MD5, HMAC SHA-384 (48 bytes) or HMAC SHA-256 (32 bytes), HMAC SHA-224 and HMAC SHA-1**] and cryptographic key sizes [**4-64 bytes**] that meet the following: [**rfc2104 & 2085 & 3874**].

Application note:

The TOE shall provide a subset of cryptographic operations defined in [JCAPI222] (see javacardx.crypto.Cipher and javacardx.security packages).

FDP_RIP.1/ABORT Subset residual information protection

FDP_RIP.1.1/ABORT The TSF shall ensure that any previous information content of a resource is made unavailable upon the **deallocation of the resource from the**

	Reference	D1226479	Release	1.3p <small>(Printed copy not controlled: verify the version before using)</small>
	Classification level	Public	Pages	177

following objects: **any reference to an object instance created during an aborted transaction.**

Application note:

The events that provoke the de-allocation of a transient object are described in [JCRE301], §5.1.

FDP_RIP.1/APDU Subset residual information protection

FDP_RIP.1.1/APDU The TSF shall ensure that any previous information content of a resource is made unavailable upon the **allocation of the resource to** the following objects: **the APDU buffer.**

Application note:

The allocation of a resource to the APDU buffer is typically performed as the result of a call to the process() method of an applet.

FDP_RIP.1/bArray Subset residual information protection

FDP_RIP.1.1/bArray The TSF shall ensure that any previous information content of a resource is made unavailable upon the **deallocation of the resource from** the following objects: **the bArray object.**

Application note:

A resource is allocated to the bArray object when a call to an applet's install() method is performed. There is no conflict with FDP_ROL.1 here because of the bounds on the rollback mechanism (FDP_ROL.1.2/FIREWALL): the scope of the rollback does not extend outside the execution of the install() method, and the de-allocation occurs precisely right after the return of it.

	Reference	D1226479	Release	1.3p <small>(Printed copy not controlled: verify the version before using)</small>
	Classification level	Public	Pages	177

FDP_RIP.1/KEYS Subset residual information protection

FDP_RIP.1.1/KEYS The TSF shall ensure that any previous information content of a resource is made unavailable upon the **deallocation of the resource from** the following objects: **the cryptographic buffer (D.CRYPTO)**.

Application note:

The javacard.security & javacardx.crypto packages do provide secure interfaces to the cryptographic buffer in a transparent way. See javacard.security.KeyBuilder and Key interface of [JCAPI222].

FDP_RIP.1/TRANSIENT Subset residual information protection

FDP_RIP.1.1/TRANSIENT The TSF shall ensure that any previous information content of a resource is made unavailable upon the **deallocation of the resource from** the following objects: **any transient object**.

Application note:

The events that provoke the de-allocation of any transient object are described in [JCRE301], §5.1 and §3.6.1.

The clearing of CLEAR_ON_DESELECT objects is not necessarily performed when the owner of the objects is deselected. In the presence of multiselectable applet instances, CLEAR_ON_DESELECT memory segments may be attached to applets that are active in different logical channels. Multiselectable applet instances within a same package must share the transient memory segment if they are concurrently active ([JCRE301], §4.2.

Moreover in [JCRE301]§3.6.1, Transient data of CLEAR_ON_DESELECT objects associated with each applet instance that was active on a logical channel over the contactless I/O interface and that does not have an applet instance from the same package active on any logical channel over the contacted I/O interface, is reset to the default value.

	Reference	D1226479	Release	1.3p <small>(Printed copy not controlled: verify the version before using)</small>
	Classification level	Public	Pages	177

FDP_ROL.1/FIREWALL Basic rollback

FDP_ROL.1.1/FIREWALL The TSF shall enforce **the FIREWALL access control SFP and the JCVM information flow control SFP** to permit the rollback of the operations **OP.JAVA** and **OP.CREATE** on the **object O.JAVAOBJECT**.

FDP_ROL.1.2/FIREWALL The TSF shall permit operations to be rolled back within the **scope of a select(), deselect(), process(), install() or uninstall() call, notwithstanding the restrictions given in [JCRE222], §7.7, within the bounds of the Commit Capacity ([JCRE222], §7.8), and those described in [JCAPI222]**.

Application note:

Transactions are a service offered by the APIs to applets. It is also used by some APIs to guarantee the atomicity of some operation. This mechanism is either implemented in Java Card platform or relies on the transaction mechanism offered by the underlying platform. Some operations of the API are not conditionally updated, as documented in [JCAPI222] (see for instance, PIN-blocking, PIN-checking, update of Transient objects).

Card Security Management

FAU_ARP.1 Security alarms

FAU_ARP.1.1 The TSF shall take **one of the following actions:**
throw an exception,
lock the card session,
reinitialize the Java Card System and its data,
upon detection of a potential security violation.

Refinement:

The "potential security violation" stands for one of the following events:

- CAP file inconsistency,
- typing error in the operands of a bytecode,
- applet life cycle inconsistency,
- card tearing (unexpected removal of the Card out of the CAD) and power failure,
- abort of a transaction in an unexpected context, (see abortTransaction(), [JCAPI222] and ([JCRE222], §7.6.2)
- violation of the Firewall or JCVM SFPs,
- unavailability of resources,
- array overflow.

	Reference	D1226479	Release	1.3p <small>(Printed copy not controlled: verify the version before using)</small>
	Classification level	Public	Pages	177

FDP_SDI.2 Stored data integrity monitoring and action

FDP_SDI.2.1 The TSF shall monitor user data stored in containers controlled by the TSF for **integrity errors** on all objects, based on the following attributes: **integrityCheckData**.

FDP_SDI.2.2 Upon detection of a data integrity error, the TSF **shall increase a counter of integrity error event and mute the card if counter is greater than max value**.

Application note:

The following data persistently stored by TOE have an integrity check data security attribute:

* PIN (objects instance of class OwnerPin), * Key (i.e. objects instance of classes implemented the interface Key), * package.

FPR_UNO.1 Unobservability

FPR_UNO.1.1 The TSF shall ensure that **[any user]** are unable to observe the operation **[read, write, cryptographic operations]** on **[PIN,Key]** by **[any other user or subject]**.

Application note:

Although it is not required in [JCRE222] specifications, the non-observability of operations on sensitive information such as keys appears as impossible to circumvent in the smart card world.

FPT_FLS.1/JCS Failure with preservation of secure state

FPT_FLS.1.1/JCS The TSF shall preserve a secure state when the following types of failures occur: **those associated to the potential security violations described in FAU_ARP.1**.

Application note:

The Java Card RE Context is the Current context when the Java Card VM begins running after a card reset ([JCRE222], §6.2.3) or after a proximity card (PICC) activation sequence ([JCRE222]). Behavior of the TOE on power loss and reset is described in [JCRE222], §3.6 and §7.1. Behavior of the TOE on RF signal loss is described in [JCRE222], §3.6.1.

	Reference	D1226479	Release	1.3p <small>(Printed copy not controlled: verify the version before using)</small>
	Classification level	Public	Pages	177

FPT_TDC.1 Inter-TSF basic TSF data consistency

FPT_TDC.1.1 The TSF shall provide the capability to consistently interpret **the CAP files, the bytecode and its data arguments** when shared between the TSF and another trusted IT product.

FPT_TDC.1.2 The TSF shall use **the rules defined in [JCVM222] specification, the API tokens defined in the export files of reference implementation,** when interpreting the TSF data from another trusted IT product.

Application note:

Concerning the interpretation of data between the TOE and the underlying Java Card platform, it is assumed that the TOE is developed consistently with the SCP functions, including memory management, I/O functions and cryptographic functions.

AID Management

FIA_ATD.1/AID User attribute definition

FIA_ATD.1.1/AID The TSF shall maintain the following list of security attributes belonging to individual users:

**Package AID,
Applet's version number,
Registered applet AID,
Applet Selection Status ([JCVM222], §6.5).**

Refinement:

"Individual users" stand for applets.

FIA_UID.2/AID User identification before any action

FIA_UID.2.1/AID The TSF shall require each user to be successfully identified before allowing any other TSF-mediated actions on behalf of that user.

Application note:

By users here it must be understood the ones associated to the packages (or applets) that act as subjects of policies. In the Java Card System, every action is always performed by an identified user interpreted here as the currently selected applet or the package that is the subject's owner. Means of identification are provided during the loading procedure of the package and the registration of applet instances.

	Reference D1226479	Release 1.3p <small>(Printed copy not controlled: verify the version before using)</small>
	Classification level Public	Pages 177

The role Java Card RE defined in FMT_SMR.1 is attached to an IT security function rather than to a "user" of the CC terminology. The Java Card RE does not "identify" itself to the TOE, but it is part of it.

FIA_USB.1/AID User-subject binding

FIA_USB.1.1/AID The TSF shall associate the following user security attributes with subjects acting on the behalf of that user: **Package AID, active context.**

FIA_USB.1.2/AID The TSF shall enforce the following rules on the initial association of user security attributes with subjects acting on the behalf of users: **Package AID is defined with associated value during loading and with context identifier.**

FIA_USB.1.3/AID The TSF shall enforce the following rules governing changes to the user security attributes associated with subjects acting on the behalf of users: **[None].**

Application note:

The user is the applet and the subject is the S.PACKAGE. The subject security attribute "Context" shall hold the user security attribute "package AID".

FMT_MTD.1/JCRE Management of TSF data

FMT_MTD.1.1/JCRE The TSF shall restrict the ability to **modify the list of registered applets' AIDs to the JCRE.**

Application note:

The installer and the Java Card RE manage other TSF data such as the applet life cycle or CAP files, but this management is implementation specific. Objects in the Java programming language may also try to query AIDs of installed applets through the lookupAID(...) API method.

The installer, applet deletion manager or even the card manager may be granted the right to modify the list of registered applets' AIDs in specific implementations (possibly needed for installation and deletion; see #.DELETION and #.INSTALL).

	Reference	D1226479	Release	1.3p <small>(Printed copy not controlled: verify the version before using)</small>
	Classification level	Public	Pages	177

FMT_MTD.3/JCRE Secure TSF data

FMT_MTD.3.1/JCRE The TSF shall ensure that only secure values are accepted for **the registered applets' AIDs**.

6.1.2.2 InstG Security Functional Requirements

This group consists of the SFRs related to the installation of the applets, which addresses security aspects outside the runtime. The installation of applets is a critical phase, which lies partially out of the boundaries of the firewall, and therefore requires specific treatment. In this PP, loading a package or installing an applet modeled as importation of user data (that is, user application's data) with its security attributes (such as the parameters of the applet used in the firewall rules).

FDP_ITC.2/Installer Import of user data with security attributes

FDP_ITC.2.1/Installer The TSF shall enforce the **PACKAGE LOADING information flow control SFP** when importing user data, controlled under the SFP, from outside of the TOE.

FDP_ITC.2.2/Installer The TSF shall use the security attributes associated with the imported user data.

FDP_ITC.2.3/Installer The TSF shall ensure that the protocol used provides for the unambiguous association between the security attributes and the user data received.

FDP_ITC.2.4/Installer The TSF shall ensure that interpretation of the security attributes of the imported user data is as intended by the source of the user data.

FDP_ITC.2.5/Installer The TSF shall enforce the following rules when importing user data controlled under the SFP from outside the TOE:

Package loading is allowed only if, for each dependent package, its AID attribute is equal to a resident package AID attribute, the major (minor) Version attribute associated to the dependent package is lesser than or equal to the major (minor) Version attribute associated to the resident package ([JCVM222], §4.5.2)..

Application note:

FDP_ITC.2.1/Installer:

The most common importation of user data is package loading and applet installation on the behalf of the installer. Security attributes consist of the shareable flag of the class component, AID and version numbers of the package, maximal operand stack size and

	Reference	D1226479	Release	1.3p <small>(Printed copy not controlled: verify the version before using)</small>
	Classification level	Public	Pages	177

FPT_FLS.1/Installer Failure with preservation of secure state

FPT_FLS.1.1/Installer The TSF shall preserve a secure state when the following types of failures occur: **the installer fails to load/install a package/applet as described in [JCRE222] §11.1.4.**

Application note:

The TOE may provide additional feedback information to the card manager in case of potential security violations (see FAU_ARP.1).

FPT_RCV.3/Installer Automated recovery without undue loss

FPT_RCV.3.1/Installer When automated recovery from **a failure or service discontinuity** is not possible, the TSF shall enter a maintenance mode where the ability to return to a secure state is provided.

FPT_RCV.3.2/Installer For **[detection of a potential loss of integrity during the transmission of an Executable Load File to the card, abortion of the installation process of an Executable Load File, or any fatal error occurred during the linking of an Executable Load File to the Executable Files already installed on the card]**, the TSF shall ensure the return of the TOE to a secure state using automated procedures.

FPT_RCV.3.3/Installer The functions provided by the TSF to recover from failure or service discontinuity shall ensure that the secure initial state is restored without exceeding **[the loss of the Executable Load File being installed]** for loss of TSF data or objects under the control of the TSF.

FPT_RCV.3.4/Installer The TSF shall provide the capability to determine the objects that were or were not capable of being recovered.

Application note:

FPT_RCV.3.1/Installer:

This element is not within the scope of the Java Card specification, which only mandates the behavior of the Java Card System in good working order. Further details on the "maintenance mode" shall be provided in specific implementations. The following is an excerpt from [CC-2], p298: In this maintenance mode normal operation might be impossible or severely restricted, as otherwise insecure situations might occur. Typically, only authorised users should be allowed access to this mode but the real details of who can access this mode is a function of FMT: Security management. If FMT: Security management does not put any controls on who can access this mode, then it may be acceptable to allow any user to restore the system if the TOE enters such a state. However, in practice, this is probably not desirable

	Reference	D1226479	Release	1.3p <small>(Printed copy not controlled: verify the version before using)</small>
	Classification level	Public	Pages	177

FDP_ACC.2.2/ADEL The TSF shall ensure that all operations between any subject controlled by the TSF and any object controlled by the TSF are covered by an access control SFP.

FDP_ACF.1/ADEL Security attribute based access control

FDP_ACF.1.1/ADEL The TSF shall enforce the **ADEL access control SFP** to objects based on the following:

Subject/Object	Attributes
S.JCVM	Active Applets
S.JCRE	Selected Applet Context, Registered Applets, Resident Packages
O.CODE_PKG	Package AID, Dependent Package AID, Static References
O.APPLET	Applet Selection Status
O.JAVAOBJECT	Owner, Remote

FDP_ACF.1.2/ADEL The TSF shall enforce the following rules to determine if an operation among controlled subjects and controlled objects is allowed:

In the context of this policy, an object O is reachable if and only one of the following conditions hold:

- (1) the owner of O is a registered applet instance A (O is reachable from A),
- (2) a static field of a resident package P contains a reference to O (O is reachable from P),
- (3) there exists a valid remote reference to O (O is remote reachable),
- (4) there exists an object O' that is reachable according to either (1) or (2) or (3) above and O' contains a reference to O (the reachability status of O is that of O').

The following access control rules determine when an operation among controlled subjects and objects is allowed by the policy:

R.JAVA.14 ([JCRE222], §11.3.4.1, Applet Instance Deletion): S.ADEL may perform OP.DELETE_APPLET upon an O.APPLET only if,

- (1) S.ADEL is currently selected,
- (2) there is no instance in the context of O.APPLET that is active in any logical channel and
- (3) there is no O.JAVAOBJECT owned by O.APPLET such that either O.JAVAOBJECT is reachable from an applet instance distinct from O.APPLET, or O.JAVAOBJECT is reachable from a package P, or ([JCRE222], §8.5) O.JAVAOBJECT is remote reachable.

R.JAVA.15 ([JCRE222], §11.3.4.1, Multiple Applet Instance Deletion): S.ADEL may perform OP.DELETE_APPLET upon several O.APPLET only if,

	Reference	D1226479	Release	1.3p <small>(Printed copy not controlled: verify the version before using)</small>
	Classification level	Public	Pages	177

- (1) S.ADEL is currently selected,
- (2) there is no instance of any of the O.APPLET being deleted that is active in any logical channel and
- (3) there is no O.JAVAOBJECT owned by any of the O.APPLET being deleted such that either O.JAVAOBJECT is reachable from an applet instance distinct from any of those O.APPLET, or O.JAVAOBJECT is reachable from a package P, or ([JCRE222], §8.5) O.JAVAOBJECT is remote reachable.

R.JAVA.16 ([JCRE222], §11.3.4.2, Applet/Library Package Deletion): S.ADEL may perform OP.DELETE_PKG upon an O.CODE_PKG only if,

- (1) S.ADEL is currently selected,
- (2) no reachable O.JAVAOBJECT, from a package distinct from O.CODE_PKG that is an instance of a class that belongs to O.CODE_PKG, exists on the card and
- (3) there is no resident package on the card that depends on O.CODE_PKG.

R.JAVA.17 ([JCRE222], §11.3.4.3, Applet Package and Contained Instances Deletion): S.ADEL may perform OP.DELETE_PKG_APPLET upon an O.CODE_PKG only if,

- (1) S.ADEL is currently selected,
- (2) no reachable O.JAVAOBJECT, from a package distinct from O.CODE_PKG, which is an instance of a class that belongs to O.CODE_PKG exists on the card,
- (3) there is no package loaded on the card that depends on O.CODE_PKG, and
- (4) for every O.APPLET of those being deleted it holds that: (i) there is no instance in the context of O.APPLET that is active in any logical channel and (ii) there is no O.JAVAOBJECT owned by O.APPLET such that either O.JAVAOBJECT is reachable from an applet instance not being deleted, or O.JAVAOBJECT is reachable from a package not being deleted, or ([JCRE222], §8.5) O.JAVAOBJECT is remote reachable.

FDP_ACF.1.3/ADEL The TSF shall explicitly authorise access of subjects to objects based on the following additional rules: **none**.

FDP_ACF.1.4/ADEL [Editorially Refined] The TSF shall explicitly deny access of **any subject but S.ADEL to O.CODE_PKG or O.APPLET for the purpose of deleting them from the card.**

Application note:

FDP_ACF.1.2/ADEL:

This policy introduces the notion of reachability, which provides a general means to describe objects that are referenced from a certain applet instance or package.

	Reference	D1226479	Release	1.3p <small>(Printed copy not controlled: verify the version before using)</small>
	Classification level	Public	Pages	177

S.ADEL calls the "uninstall" method of the applet instance to be deleted, if implemented by the applet, to inform it of the deletion request. The order in which these calls and the dependencies checks are performed are out of the scope of this protection profile.

FDP_RIP.1/ADEL Subset residual information protection

FDP_RIP.1.1/ADEL The TSF shall ensure that any previous information content of a resource is made unavailable upon the **deallocation of the resource from** the following objects: **applet instances and/or packages when one of the deletion operations in FDP_ACC.2.1/ADEL is performed on them.**

Application note:

Deleted freed resources (both code and data) may be reused, depending on the way they were deleted (logically or physically). Requirements on de-allocation during applet/package deletion are described in [JCRE222], §11.3.4.1, §11.3.4.2 and §11.3.4.3.

FMT_MSA.1/ADEL Management of security attributes

FMT_MSA.1.1/ADEL The TSF shall enforce the **ADEL access control SFP** to restrict the ability to **modify** the security attributes **Registered Applets and Resident Packages to the Java Card RE.**

FMT_MSA.3/ADEL Static attribute initialisation

FMT_MSA.3.1/ADEL The TSF shall enforce the **ADEL access control SFP** to provide **restrictive** default values for security attributes that are used to enforce the SFP.

FMT_MSA.3.2/ADEL The TSF shall allow the **following role(s): none**, to specify alternative initial values to override the default values when an object or information is created.

FMT_SMF.1/ADEL Specification of Management Functions

FMT_SMF.1.1/ADEL The TSF shall be capable of performing the following management functions: **modify the list of registered applets' AIDs and the Resident Packages.**

Application note:

The modification of the Active Applets security attribute should be performed in accordance with the rules given in [JCRE222], §4.

	Reference	D1226479	Release	1.3p <small>(Printed copy not controlled: verify the version before using)</small>
	Classification level	Public	Pages	177

FMT_SMR.1/ADEL Security roles

FMT_SMR.1.1/ADEL The TSF shall maintain the roles: **applet deletion manager**.

FMT_SMR.1.2/ADEL The TSF shall be able to associate users with roles.

FPT_FLS.1/ADEL Failure with preservation of secure state

FPT_FLS.1.1/ADEL The TSF shall preserve a secure state when the following types of failures occur: **the applet deletion manager fails to delete a package/applet as described in [JCRE222], §11.3.4.**

Application note:

The TOE may provide additional feedback information to the card manager in case of a potential security violation (see FAU_ARP.1).

The Package/applet instance deletion must be atomic. The "secure state" referred to in the requirement must comply with Java Card specification ([JCRE222], §11.3.4.)

6.1.2.4 RMIG Security Functional Requirements

This group specifies the policies that control the access to the remote objects and the flow of information that takes place when the RMI service is used. The rules relate mainly to the lifetime of the remote references. Information concerning remote object references can be sent out of the card only if the corresponding remote object has been designated as exportable. Array parameters of remote method invocations must be allocated on the card as global arrays. Therefore, the storage of references to those arrays must be restricted as well. The JCRMI policy embodies both an access control and an information flow control policy.

FDP_ACC.2/JCRMI Complete access control

FDP_ACC.2.1/JCRMI The TSF shall enforce the **JCRMI access control SFP** on **S.CAD, S.JCRE, O.APPLET, O.REMOTE_OBJ, O.REMOTE_MTHD, O.ROR, O.RMI_SERVICE** and all operations among subjects and objects covered by the SFP.

Refinement:

The operations involved in this policy are:

OP.GET_ROR,
OP.INVOKE.

	Reference	D1226479	Release	1.3p <small>(Printed copy not controlled: verify the version before using)</small>
	Classification level	Public	Pages	177

FDP_ACC.2.2/JCRMI The TSF shall ensure that all operations between any subject controlled by the TSF and any object controlled by the TSF are covered by an access control SFP.

FDP_ACF.1/JCRMI Security attribute based access control

FDP_ACF.1.1/JCRMI The TSF shall enforce the **JCRMI access control SFP** to objects based on the following:

Subject/Object	Attributes
S.JCRE	Selected Applet Context
O.REMOTE_OBJ	Owner, Class, Identifier, ExportedInfo
O.REMOTE_MTHD	Identifier
O.RMI_SERVICE	Owner, Returned References

FDP_ACF.1.2/JCRMI The TSF shall enforce the following rules to determine if an operation among controlled subjects and controlled objects is allowed:

R.JAVA.18: S.CAD may perform OP.GET_ROR upon O.APPLET only if O.APPLET is the currently selected applet, and there exists an O.RMI_SERVICE with a registered initial reference to an O.REMOTE_OBJ that is owned by O.APPLET.

R.JAVA.19: S.JCRE may perform OP.INVOKE upon O.RMI_SERVICE, O.ROR and O.REMOTE_MTHD only if O.ROR is valid (as defined in [JCRE222], §8.5) and it belongs to the Returned References of O.RMI_SERVICE, and if the Identifier of O.REMOTE_MTHD matches one of the remote methods in the Class of the O.REMOTE_OBJ to which O.ROR makes reference.

FDP_ACF.1.3/JCRMI The TSF shall explicitly authorise access of subjects to objects based on the following additional rules: **none**.

FDP_ACF.1.4/JCRMI [Editorially Refined] The TSF shall explicitly deny access of **any subject but S.JCRE to O.REMOTE_OBJ and O.REMOTE_MTHD for the purpose of performing a remote method invocation.**

Application note:

FDP_ACF.1.2/JCRMI:

The validity of a remote object reference is specified as a lifetime characterization. The security attributes involved in the rules for determining valid remote object references are the Returned References of the O.RMI_SERVICE and the Active Applets (see FMT_REV.1.1/JCRMI and FMT_REV.1.2/JCRMI). The precise mechanism by which a

	Reference	D1226479	Release	1.3p <small>(Printed copy not controlled: verify the version before using)</small>
	Classification level	Public	Pages	177

remote method is invoked on a remote object is defined in detail in ([JCRE222], §8.5.2 and [JCAPI222]).

Note that the owner of an O.RMI_SERVICE is the applet instance that created the object. The attribute Returned References lists the remote object references that have been sent to the S.CAD during the applet selection session. This attribute is implementation dependent.

FDP_IFC.1/JCRMI Subset information flow control

FDP_IFC.1.1/JCRMI The TSF shall enforce the **JCRMI information flow control SFP** on **S.JCRE, S.CAD, I.RORD and OP.RET_RORD(S.JCRE,S.CAD,I.RORD)**.

Application note:

FDP_IFC.1.1/JCRMI:

Array parameters of remote method invocations must be allocated on the card as global arrays objects. References to global arrays cannot be stored in class variables, instance variables or array components. The control of the flow of that kind of information has already been specified in FDP_IFC.1.1/JCVM.

A remote object reference descriptor is sent from the card to the CAD either as the result of a successful applet selection command ([JCRE222], §8.4.1), and in this case it describes, if any, the initial remote object reference of the selected applet; or as the result of a remote method invocation ([JCRE222],§8.3.5.1).

FDP_IFF.1/JCRMI Simple security attributes

FDP_IFF.1.1/JCRMI The TSF shall enforce the **JCRMI information flow control SFP** based on the following types of subject and information security attributes:

Subjects/Information	Security attributes
I.RORD	ExportedInfo

FDP_IFF.1.2/JCRMI The TSF shall permit an information flow between a controlled subject and controlled information via a controlled operation if the following rules hold:

OP.RET_RORD(S.JCRE, S.CAD, I.RORD) is permitted only if the attribute ExportedInfo of I.RORD has the value "true" ([JCRE222], §8.5).

	Reference	D1226479	Release	1.3p <small>(Printed copy not controlled: verify the version before using)</small>
	Classification level	Public	Pages	177

FDP_IFF.1.3/JCRMI The TSF shall enforce the **[no additional information flow control SFP rules]**.

FDP_IFF.1.4/JCRMI The TSF shall explicitly authorise an information flow based on the following rules: **[no additional rules]**.

FDP_IFF.1.5/JCRMI The TSF shall explicitly deny an information flow based on the following rules: **[no additional rules]**.

Application note:

The ExportedInfo attribute of I.RORD indicates whether the O.REMOTE_OBJ which I.RORD identifies is exported or not (as indicated by the security attribute ExportedInfo of the O.REMOTE_OBJ).

FMT_MSA.1/EXPORT Management of security attributes

FMT_MSA.1.1/EXPORT The TSF shall enforce the **JCRMI access control SFP** to restrict the ability to **modify** the security attributes: **ExportedInfo of O.REMOTE_OBJ to its owner applet.**

Application note:

The Exported status of a remote object can be modified by invoking its methods export() and unexport(), and only the owner of the object may perform the invocation without raising a SecurityException (javacard.framework.service.CardRemoteObject). However, even if the owner of the object may provoke the change of the security attribute value, the modification itself can be performed by the Java Card RE.

FMT_MSA.1/REM_REFS Management of security attributes

FMT_MSA.1.1/REM_REFS The TSF shall enforce the **JCRMI access control SFP** to restrict the ability to **modify** the security attributes **Returned References of O.RMI_SERVICE to its owner applet.**

	Reference	D1226479	Release	1.3p <small>(Printed copy not controlled: verify the version before using)</small>
	Classification level	Public	Pages	177

FMT_MSA.3/JCRMI Static attribute initialisation

FMT_MSA.3.1/JCRMI The TSF shall enforce the **JCRMI access control SFP and the JCRMI information flow control SFP** to provide **restrictive** default values for security attributes that are used to enforce the SFP.

FMT_MSA.3.2/JCRMI The TSF shall allow the **following role(s): none**, to specify alternative initial values to override the default values when an object or information is created.

Application note:

FMT_MSA.3.1/JCRMI:

Remote objects' security attributes are created and initialized at the creation of the object, and except for the ExportedInfo attribute, the values of the attributes are not longer modifiable. The default value of the Exported attribute is true. There is one default value for the Selected Applet Context that is the default applet identifier's context, and one default value for the active context, that is "Java Card RE".

FMT_MSA.3.2/JCRMI:

The intent is to have none of the identified roles to have privileges with regards to the default values of the security attributes. It should be noticed that creation of objects is an operation controlled by the FIREWALL access control SFP.

FMT_REV.1/JCRMI Revocation

FMT_REV.1.1/JCRMI [Editorially Refined] The TSF shall restrict the ability to revoke **the Returned References of O.RMI_SERVICE to the Java Card RE.**

FMT_REV.1.2/JCRMI The TSF shall enforce the rules **that determine the lifetime of remote object references.**

Application note:

The rules are described in [JCRE222], §8.5

FMT_SMF.1/JCRMI Specification of Management Functions

FMT_SMF.1.1/JCRMI The TSF shall be capable of performing the following management functions:

modify the security attribute ExportedInfo of O.REMOTE_OBJ,

	Reference	D1226479	Release	1.3p <small>(Printed copy not controlled: verify the version before using)</small>
	Classification level	Public	Pages	177

modify the security attribute Returned References of O.RMI_SERVICE.

FMT_SMR.1/JCRMI Security roles

FMT_SMR.1.1/JCRMI The TSF shall maintain the roles: **applet**.

FMT_SMR.1.2/JCRMI The TSF shall be able to associate users with roles.

Application note:

Applets own remote interface objects and may choose to allow or forbid their exportation, which is managed through a security attribute.

6.1.2.5 ODELG Security Functional Requirements

The following requirements concern the object deletion mechanism. This mechanism is triggered by the applet that owns the deleted objects by invoking a specific API method.

FDP_RIP.1/ODEL Subset residual information protection

FDP_RIP.1.1/ODEL The TSF shall ensure that any previous information content of a resource is made unavailable upon the **deallocation of the resource from** the following objects: **the objects owned by the context of an applet instance which triggered the execution of the method `javacard.framework.JCSystem.requestObjectDeletion()`**

Application note:

Freed data resources resulting from the invocation of the method `javacard.framework.JCSystem.requestObjectDeletion()` may be reused. Requirements on de-allocation after the invocation of the method are described in [JCAPI222].

There is no conflict with FDP_ROL.1 here because of the bounds on the rollback mechanism: the execution of `requestObjectDeletion()` is not in the scope of the rollback because it must be performed in between APDU command processing, and therefore no transaction can be in progress.

	Reference	D1226479	Release	1.3p <small>(Printed copy not controlled: verify the version before using)</small>
	Classification level	Public	Pages	177

FPT_FLS.1/ODEL Failure with preservation of secure state

FPT_FLS.1.1/ODEL The TSF shall preserve a secure state when the following types of failures occur: **the object deletion functions fail to delete all the unreferenced objects owned by the applet that requested the execution of the method.**

Application note:

The TOE may provide additional feedback information to the card manager in case of potential security violation (see FAU_ARP.1).

6.1.2.6 CarG Security Functional Requirements

This group includes requirements for preventing the installation of packages that has not been bytecode verified, or that has been modified after bytecode verification.

FCO_NRO.2/CM Enforced proof of origin

FCO_NRO.2.1/CM The TSF shall enforce the generation of evidence of origin for transmitted **application packages** at all times.

FCO_NRO.2.2/CM [Editorially Refined] The TSF shall be able to relate the **identity** of the originator of the information, and the **application package contained in** the information to which the evidence applies.

FCO_NRO.2.3/CM The TSF shall provide a capability to verify the evidence of origin of information to **recipient** given **as assumption the key used is kept integer and confidential by origin.**

Application note:

FCO_NRO.2.1/CM:

Upon reception of a new application package for installation, the card manager shall first check that it actually comes from the verification authority. The verification authority is the entity responsible for bytecode verification.

FCO_NRO.2.3/CM:

The exact limitations on the evidence of origin are implementation dependent. In most of the implementations, the card manager performs an immediate verification of the origin of the package using an electronic signature mechanism, and no evidence is kept on the card for future verifications.

	Reference	D1226479	Release	1.3p <small>(Printed copy not controlled: verify the version before using)</small>
	Classification level	Public	Pages	177

FDP_IFC.2/CM Complete information flow control

FDP_IFC.2.1/CM The TSF shall enforce the **PACKAGE LOADING information flow control SFP** on **S.INSTALLER, S.BCV, S.CAD and I.APDU** and all operations that cause that information to flow to and from subjects covered by the SFP.

FDP_IFC.2.2/CM The TSF shall ensure that all operations that cause any information in the TOE to flow to and from any subject in the TOE are covered by an information flow control SFP.

Application note:

The subjects covered by this policy are those involved in the loading of an application package by the card through a potentially unsafe communication channel.

The operations that make information to flow between the subjects are those enabling to send a message through and to receive a message from the communication channel linking the card to the outside world. It is assumed that any message sent through the channel as clear text can be read by an attacker. Moreover, an attacker may capture any message sent through the communication channel and send its own messages to the other subjects.

The information controlled by the policy is the APDUs exchanged by the subjects through the communication channel linking the card and the CAD. Each of those messages contain part of an application package that is required to be loaded on the card, as well as any control information used by the subjects in the communication protocol.

FDP_IFF.1/CM Simple security attributes

FDP_IFF.1.1/CM The TSF shall enforce the **PACKAGE LOADING information flow control SFP** based on the following types of subject and information security attributes: **[the Command Security Level defined for the messages that the card receives through the secure channel]**.

FDP_IFF.1.2/CM The TSF shall permit an information flow between a controlled subject and controlled information via a controlled operation if the following rules hold: **[assignment: the rules describing the communication protocol used by the CAD and the card for transmitting a new package]**.

FDP_IFF.1.3/CM The TSF shall enforce the **[possible security levels are: NO-SEC (clear text), C-AUTHENTICATED (authentication of the command's emitter), C-MAC (authentication of the emitter and integrity of the command), C-DEC (authentication of the emitter, integrity and confidentiality of the command)]**.

FDP_IFF.1.4/CM The TSF shall explicitly authorise an information flow based on the following rules: **[the SD may process:**
an (INITIALIZE-UPDATE) operation only if the key set specified in the command exist,

	Reference	D1226479	Release	1.3p <small>(Printed copy not controlled: verify the version before using)</small>
	Classification level	Public	Pages	177

an (EXTERNAL-AUTHENTICATE) operation if the following conditions are fulfilled: 1) The cryptogram received from the off-card subject is equal to the cryptogram computed by the Security Domain. 2) The MAC attached to the message has been generated using the CMAC session key and the current value of the ICV.

a (GET-DATA) operation if the following conditions are fulfilled: 1) If the command security level is at least C-MAC, 2) the MAC attached to the message has been generated from the command using the C-MAC session key and the current value of the ICV.

any received operation for any other command if the following conditions hold: 1) The current security level is at least AUTHENTICATED. 2) If the command security level is at least C-MAC, the MAC attached to the message has been generated from the clear-text command using the C-MAC session key and the current value of the ICV.

FDP_IFF.1.5/CM The TSF shall explicitly deny an information flow based on the following rules: **[A Security Domain may always process a (SELECT) operation or a (Get DATA) operation at the security level NO-SEC].**

Application note:

FDP_IFF.1.1/CM:

The security attributes used to enforce the PACKAGE LOADING SFP are implementation dependent. More precisely, they depend on the communication protocol enforced between the CAD and the card. For instance, some of the attributes that can be used are: (1) the keys used by the subjects to encrypt/decrypt their messages; (2) the number of pieces the application package has been split into in order to be sent to the card; (3) the ordinal of each piece in the decomposition of the package, etc. See for example Appendix D of [GP].

FDP_IFF.1.2/CM:

The precise set of rules to be enforced by the function is implementation dependent. The whole exchange of messages shall verify at least the following two rules: (1) the subject S.INSTALLER shall accept a message only if it comes from the subject S.CAD; (2) the subject S.INSTALLER shall accept an application package only if it has received without modification and in the right order all the APDUs sent by the subject S.CAD.

	Reference	D1226479	Release	1.3p <small>(Printed copy not controlled: verify the version before using)</small>
	Classification level	Public	Pages	177

FDP_UIT.1/CM Data exchange integrity

FDP_UIT.1.1/CM The TSF shall enforce the **PACKAGE LOADING information flow control SFP** to **receive** user data in a manner protected from **modification, deletion, insertion and replay** errors.

FDP_UIT.1.2/CM [Editorially Refined] The TSF shall be able to determine on receipt of user data, whether **modification, deletion, insertion, replay of some of the pieces of the application sent by the CAD** has occurred.

Application note:

Modification errors should be understood as modification, substitution, unrecoverable ordering change of data and any other integrity error that may cause the application package to be installed on the card to be different from the one sent by the CAD.

FIA_UID.1/CM Timing of identification

FIA_UID.1.1/CM The TSF shall allow **selection of a security domain and execution of Card Manager** on behalf of the user to be performed before the user is identified.

FIA_UID.1.2/CM The TSF shall require each user to be successfully identified before allowing any other TSF-mediated actions on behalf of that user.

Application note:

The list of TSF-mediated actions is implementation-dependent, but package installation requires the user to be identified. Here by user is meant the one(s) that in the Security Target shall be associated to the role(s) defined in the component FMT_SMR.1/CM.

FMT_MSA.1/CM Management of security attributes

FMT_MSA.1.1/CM The TSF shall enforce the **PACKAGE LOADING information flow control SFP** to restrict the ability to **modify** the security attributes [**Card Life cycle, Security Level**] to [**Card Manager**].

	Reference	D1226479	Release	1.3p <small>(Printed copy not controlled: verify the version before using)</small>
	Classification level	Public	Pages	177

FMT_MSA.3/CM Static attribute initialisation

FMT_MSA.3.1/CM The TSF shall enforce the **PACKAGE LOADING information flow control SFP** to provide **restrictive** default values for security attributes that are used to enforce the SFP.

FMT_MSA.3.2/CM The TSF shall allow the **[none]** to specify alternative initial values to override the default values when an object or information is created.

FMT_SMF.1/CM Specification of Management Functions

FMT_SMF.1.1/CM The TSF shall be capable of performing the following management functions: **[modification of the Card life cycle inducing availability of management functions]**.

FMT_SMR.1/CM Security roles

FMT_SMR.1.1/CM The TSF shall maintain the roles **[S.CAD, S.CARDMANAGER]**.

FMT_SMR.1.2/CM The TSF shall be able to associate users with roles.

FTP_ITC.1/CM Inter-TSF trusted channel

FTP_ITC.1.1/CM The TSF shall provide a communication channel between itself and another trusted IT product that is logically distinct from other communication channels and provides assured identification of its end points and protection of the channel data from modification or disclosure.

FTP_ITC.1.2/CM [Editorially Refined] The TSF shall permit **the CAD placed in the card issuer secured environment** to initiate communication via the trusted channel.

FTP_ITC.1.3/CM The TSF shall initiate communication via the trusted channel for **loading/installing a new application package on the card.**

Application note:

There is no dynamic package loading on the Java Card platform. New packages can be installed on the card only on demand of the card issuer.

6.1.2.7 SCP

This section states the security functional requirements for the Smart Card Platform.

	Reference	D1226479	Release	1.3p <small>(Printed copy not controlled: verify the version before using)</small>
	Classification level	Public	Pages	177

Operating System

This section presents those requirements of the Smart Card Platform group that concern the Operating System. Due to enlargement in the scope of evaluation, the requirements related to OS are now assigned to the TOE and no more to the environment. Other internal security mechanisms are not addressed by SFR but ADV_ARC activities.

FPT_RCV.3/OS Automated recovery without undue loss

FPT_RCV.3.1/OS When automated recovery from **security policy violation** is not possible, the TSF shall enter a maintenance mode where the ability to return to a secure state is provided.

FPT_RCV.3.2/OS For **execution access to a memory zone reserved for TSF data, writing access to a memory zone reserved for TSF's code, and any segmentation fault performed by a Java Card applet**, the TSF shall ensure the return of the TOE to a secure state using automated procedures.

FPT_RCV.3.3/OS The functions provided by the TSF to recover from failure or service discontinuity shall ensure that the secure initial state is restored without exceeding **o the contents of Java Card static fields, instance fields, and array positions that fall under the scope of an open transaction; o the Java Card objects that were allocated into the scope of an open transaction; o the contents of Java Card transient objects; o any possible Executable Load File being loaded when the failure occurred** for loss of TSF data or objects under the control of the TSF.

FPT_RCV.3.4/OS The TSF shall provide the capability to determine the objects that were or were not capable of being recovered.

FPT_RCV.4/OS Function recovery

FPT_RCV.4.1/OS The TSF shall ensure that **reading from and writing to static and objects' fields interrupted by power loss** have the property that the function either completes successfully, or for the indicated failure scenarios, recovers to a consistent and secure state.

Integrated Circuit

The section should contain the requirements of the Smart Card Platform group introduced in [JCSPP] concerning the Integrated Circuit. Due to enlargement in the scope of evaluation, the requirements related to IC are now assigned to the TOE and no more to the environment.

Those requirements are fulfilled in the [ICST] and are covered by the IC certificate reused in the composite evaluation process. There are not repeated here.

	Reference	D1226479	Release	1.3p <small>(Printed copy not controlled: verify the version before using)</small>
	Classification level	Public	Pages	177

They mainly concern protecting the smart card's chip against physical tampering, preventing the disclosure of information when it is transferred from different physical parts of the chip, providing the basic DES operation, and keeping a secure state when a malfunction is detected and providing an independent security domain for the hardware.

6.1.3 (U)SIM

6.1.3.1 Crypto JCAPI

FCS_COP.1/SHA2 Cryptographic operation

FCS_COP.1.1/SHA2 The TSF shall perform **[computation of a hash value for applet instance's data]** in accordance with a specified cryptographic algorithm **[SHA-384 (48 bytes) or SHA-256 (32 bytes) or SHA2-224 (32 bytes)]** and cryptographic key sizes **[None]** that meet the following: **[FIPS 180-3]**.

Application note:

The TOE shall provide a subset of cryptographic operations defined in [JCAPI222] (see javacardx.crypto.Cipher and javacardx.security packages).

FCS_COP.1/CRC Cryptographic operation

FCS_COP.1.1/CRC The TSF shall perform **[Computation of checksum CRC16 or CRC32 of applet instance's data]** in accordance with a specified cryptographic algorithm **[CRC16 or CRC32]** and cryptographic key sizes **[none]** that meet the following: **[ISO3309]**.

Application note:

The TOE shall provide a subset of cryptographic operations defined in [JCAPI222] (see javacardx.crypto.Cipher and javacardx.security packages).

FCS_RND.1 Random Number Generation

FCS_RND.1.1 The TSF shall provide a mechanism to generate random numbers that meet **the STANDARD level specified in [DCSSI2741]**.

6.1.3.2 SecureAPI

	Reference	D1226479	Release	1.3p <small>(Printed copy not controlled: verify the version before using)</small>
	Classification level	Public	Pages	177

FPT_FLS.1/SecureAPI Failure with preservation of secure state

FPT_FLS.1.1/SecureAPI The TSF shall preserve a secure state when the following types of failures occur: **the application fails to perform a specific execution flow control protected by the Secure API.**

FPT_ITT.1/SecureAPI Basic internal TSF data transfer protection

FPT_ITT.1.1/SecureAPI The TSF shall protect TSF data from **disclosure and modification** when it is transmitted between separate parts of the TOE.

FPR_UNO.1/SecureAPI Unobservability

FPR_UNO.1.1/SecureAPI The TSF shall ensure that **external attacker** are unable to observe the operation **as sensitive comparison or copy** on **sensitive objects defined by the application using the Secure API.**

6.1.3.3 GemActivate

FMT_SMR.1/GemActivate Security roles

FMT_SMR.1.1/GemActivate The TSF shall maintain the roles [**GemActivate Administrator**].

FMT_SMR.1.2/GemActivate The TSF shall be able to associate users with roles.

FMT_SMF.1/GemActivate Specification of Management Functions

FMT_SMF.1.1/GemActivate The TSF shall be capable of performing the following management functions: **activation of optional platform service.**

FMT_MOF.1/GemActivate Management of security functions behaviour

FMT_MOF.1.1/GemActivate The TSF shall restrict the ability to **disable and enable** the functions **activation or inhibition of optional platform services as: cryptographic algorithm, package, applet instance, scalability (extension of available NVM) and NFC interface (SWP, HCI gate) to GemActivate Administrator, MNO.**

	Reference	D1226479	Release	1.3p <small>(Printed copy not controlled: verify the version before using)</small>
	Classification level	Public	Pages	177

FMT_MSA.1/GemActivate Management of security attributes

FMT_MSA.1.1/GemActivate The TSF shall enforce the **GemActivate access control SFP** to restrict the ability to **modify** the security attributes **state (deactivated, activated, inhibited)** of **optional platform service** to **GemActivate Administrator** under control of **MNO**.

FMT_MTD.1/GemActivate Management of TSF data

FMT_MTD.1.1/GemActivate The TSF shall restrict the ability to **query** the [**List of deactivated/activated/ inhibited optional platform services**] to [**GemActivate Administrator and MNO**].

6.1.3.4 EMVUtilAPI

FPT_ITT.1/EMVUtilAPI Basic internal TSF data transfer protection

FPT_ITT.1.1/EMVUtilAPI The TSF shall protect TSF data from **modification** when it is transmitted between separate parts of the TOE.

FDP_SDI.1/EMVUtilAPI Stored data integrity monitoring

FDP_SDI.1.1/EMVUtilAPI The TSF shall monitor user data stored in containers controlled by the TSF for **integrity error using proprietary checksum** on all objects, based on the following attributes: **Protected array of bits, array of short or arrays of objects**.

6.2 Security Assurance Requirements

The security assurance requirement level is EAL4 augmented with ALC_DVS.2 and AVA_VAN.5.

6.3 Security Requirements Rationale

6.3.1 Objectives

6.3.1.1 Security Objectives for the TOE

(U)SIM Java card TM Platform Protection Profile

Basic TOE

Card Management

	Reference D1226479	Release 1.3p <small>(Printed copy not controlled: verify the version before using)</small>
	Classification level Public	Pages 177

O.CARD-MANAGEMENT The security objective O.CARD-MANAGEMENT is met by the following SFRs:

FDP_UIT.1/CCM enforces the Secure Channel Protocol information flow control policy and the Security Domain access control policy to ensure the integrity of card management operations.

FDP_ROL.1/CCM ensures that card management operations may be cleanly aborted.

FDP_ITC.2/CCM enforces the Firewall access control policy and the Secure Channel Protocol information flow policy when importing card management data.

FPT_FLS.1/CCM preserves a secure state when failures occur.

All SFRs related to Security Domains (FDP_ACC.1/SD, FDP_ACF.1/SD, FMT_MSA.1/SD, FMT_MSA.3/SD, FMT_SMF.1/SD, FMT_SMR.1/SD) cover this security objective by enforcing a Security Domain access control policy (rules and restrictions) that ensures a secure card content management.

All SFRs related to the secure channel (FMT_MSA.1/SC, FMT_MSA.3/SC, FMT_SMF.1/SC, FIA_UAU.1/SC, FTP_ITC.1/SC, FCO_NRO.2/SC, FDP_IFC.2/SC, FDP_IFT.1/SC, FIA_UID.1/SC, FIA_UAU.4/SC) support this security objective by enforcing Secure Channel Protocol information flow control policy that ensures the integrity and the authenticity of card management operations.

O.DOMAIN-RIGHTS The security objective O.DOMAIN-RIGHTS is met by the following SFRs:

All SFRs related to Security Domains (FDP_ACC.1/SD, FDP_ACF.1/SD, FMT_MSA.1/SD, FMT_MSA.3/SD, FMT_SMF.1/SD, FMT_SMR.1/SD) cover this security objective by enforcing a Security Domain access control policy (rules and restrictions) that ensures a secure card content management.

All SFRs related to the secure channel (FMT_MSA.1/SC, FMT_MSA.3/SC, FMT_SMF.1/SC, FIA_UAU.1/SC, FTP_ITC.1/SC, FCO_NRO.2/SC, FDP_IFC.2/SC, FDP_IFT.1/SC, FIA_UID.1/SC, FIA_UAU.4/SC) support this security objective by enforcing Secure Channel Protocol information flow control policy that ensures the integrity and the authenticity of card management operations.

O.APPLI-AUTH The security objective O.APPLI-AUTH is met by the following SFRs:

FDP_ROL.1/CCM ensures that card management operations may be cleanly aborted.

FPT_FLS.1/CCM preserves a secure state when failures occur.

FCS_COP.1/DAP compute DAP to be compared with input and ensures that the loaded Executable Application is legitimate by specifying the algorithm to be used in order to verify the DAP signature of the Verification Authority.

Communication

O.COMM_AUTH This security objective is covered by the following security functional requirements:

FTP_ITC.1/SC which ensures the origin of card administration commands.

FMT_SMR.1/SD specifies the authorized identified roles enabling to send and authenticate card management commands.

FDP_IFC.2/SC and FDP_IFT.1/SC enforces the Secure Channel Protocol information flow control policy to ensure the origin of administration requests.

	Reference D1226479	Release 1.3p <small>(Printed copy not controlled: verify the version before using)</small>
	Classification level Public	Pages 177

O.GLOBAL_ARRAYS_INTEG This objective is met by the JCVM information flow control policy (FDP_IFF.1/JCVM, FDP_IFC.1/JCVM), which prevents an application from keeping a pointer to the APDU buffer of the card or to the global byte array of the applet's install method. Such a pointer could be used to access and modify it when the buffer is being used by another application.

O.NATIVE This security objective is covered by FDP_ACF.1/FIREWALL: the only means to execute native code is the invocation of a Java Card API method. This objective mainly relies on the environmental objective OE.APPLET, which uphold the assumption A.APPLET.

O.OPERATE The TOE is protected in various ways against applets' actions (FPT_TDC.1), the FIREWALL access control policy FDP_ACC.2/FIREWALL and FDP_ACF.1/FIREWALL, and is able to detect and block various failures or security violations during usual working (FPT_FLS.1/ADEL, FPT_FLS.1/JCS, FPT_FLS.1/ODEL, FPT_FLS.1/Installer, FAU_ARP.1). Its security-critical parts and procedures are also protected: safe recovery from failure is ensured (FPT_RCV.3/Installer), applets' installation may be cleanly aborted (FDP_ROL.1/FIREWALL), communication with external users and their internal subjects is well-controlled (FDP_ITC.2/Installer, FIA_ATD.1/AID, FIA_USB.1/AID) to prevent alteration of TSF data (also protected by components of the FPT class).

Almost every objective and/or functional requirement indirectly contributes to this one too.

	Reference D1226479	Release 1.3p <small>(Printed copy not controlled: verify the version before using)</small>
	Classification level Public	Pages 177

Application note: Startup of the TOE (TSF-testing) can be covered by FPT_TST.1. This SFR component is not mandatory in [JCRE222], but appears in most of security requirements documents for masked applications. Testing could also occur randomly. Self-tests may become mandatory in order to comply to FIPS certification [FIPS 140-2].

O.REALLOCATION This security objective is satisfied by the following SFRs: FDP_RIP.1/APDU, FDP_RIP.1/bArray, FDP_RIP.1/ABORT, FDP_RIP.1/KEYS, FDP_RIP.1/TRANSIENT, FDP_RIP.1/ODEL, FDP_RIP.1/OBJECTS, FDP_RIP.1/ADEL, which imposes that the contents of the re-allocated block shall always be cleared before delivering the block.

O.RESOURCES The TSFs detects stack/memory overflows during execution of applications (FAU_ARP.1, FPT_FLS.1/ADEL, FPT_FLS.1/JCS, FPT_FLS.1/ODEL, FPT_FLS.1/Installer). Failed installations are not to create memory leaks (FDP_ROL.1/FIREWALL, FPT_RCV.3/Installer) as well. Memory management is controlled by the TSF (FMT_MTD.1/JCRE, FMT_MTD.3/JCRE, FMT_SMR.1/Installer, FMT_SMR.1, FMT_SMF.1 FMT_SMR.1/ADEL, FMT_SMR.1/JCRMI, FMT_SMF.1/ADEL, FMT_SMF.1/JCRMI, FMT_SMF.1/CM and FMT_SMR.1/CM).

SERVICES

O.ALARM This security objective is met by FPT_FLS.1/Installer, FPT_FLS.1/JCS, FPT_FLS.1/ADEL, FPT_FLS.1/ODEL which guarantee that a secure state is preserved by the TSF when failures occur, and FAU_ARP.1 which defines TSF reaction upon detection of a potential security violation.

O.CIPHER This security objective is directly covered by FCS_CKM.1/RSA, FCS_CKM.1/DES, FCS_CKM.1/AES, FCS_CKM.2/DES, FCS_CKM.2/AES, FCS_CKM.2/RSA, FCS_CKM.3/AES, FCS_CKM.3/RSA, FCS_CKM.3/DES, FCS_CKM.4, FCS_COP.1/DES_CIPHER, FCS_COP.1/AES_CIPHER, FCS_COP.1/RSA_CIPHER.

The SFR FPR_UNO.1 contributes in covering this security objective and controls the observation of the cryptographic operations which may be used to disclose the keys.

	Reference D1226479	Release 1.3p <small>(Printed copy not controlled: verify the version before using)</small>
	Classification level Public	Pages 177

integrity of the corresponding data is under the control of the PACKAGE LOADING information flow policy (FDP_IFC.2/CM, FDP_IFF.1/CM) and FDP_UIT.1/CM. Appropriate identification (FIA_UID.1/CM) and transmission mechanisms are also enforced (FTP_ITC.1/CM).

O.INSTALL This security objective specifies that installation of applets must be secure. Security attributes of installed data are under the control of the FIREWALL access control policy (FDP_ITC.2/Installer), and the TSFs are protected against possible failures of the installer (FPT_FLS.1/Installer, FPT_RCV.3/Installer).

SCP

O.SCP.RECOVERY The SCP is a part of the TOE supporting TSFs of the upper layer of the TOE, especially for recovery operations as FPT_RCV.3/OS.

O.SCP.IC The SCP.IC is a part of the TOE supporting TSFs of the upper layer of the TOE and more specially FPT_FLS.1/JCS

(U)SIM

O.Secure_API The security objective is met by the following SFR FPT_FLS.1/SecureAPI, FPT_ITT.1/SecureAPI and FPR_UNO.1/SecureAPI.

O.RND The security objective O.RND is met by the following SFR FCS_RND.1.

O.JCAPI-Services The security objective is met by the following SFR FCS_COP.1/SHA2 and FCS_COP.1/CRC.

O.REMOTE_SERVICE_AUDIT The security objective is met by the following SFR: FMT_MTD.1/GemActivate, FMT_SMR.1/GemActivate, FMT_SMF.1/GemActivate.

O.REMOTE_SERVICE_ACTIVATION The security objective is met by the following SFR: FMT_SMR.1/GemActivate, FMT_SMF.1/GemActivate, FMT_MOF.1/GemActivate, FMT_MSA.1/GemActivate.

O.EMVUtil_API The security objective is met by the following SFR: FPT_ITT.1/EMVUtilAPI, FDP_SDI.1/EMVUtilAPI.

6.3.2 Rationale tables of Security Objectives and SFRs

Security Objectives	Security Functional Requirements	Rationale
---------------------	----------------------------------	-----------

	Reference	D1226479	Release	1.3p <small>(Printed copy not controlled: verify the version before using)</small>
	Classification level	Public	Pages	177

Security Objectives	Security Functional Requirements	Rationale
O.CARD-MANAGEMENT	FDP_ACC.1/SD , FMT_MSA.1/SD , FMT_MSA.3/SD , FMT_SMF.1/SD , FMT_SMR.1/SD , FDP_UIT.1/CCM , FDP_ROL.1/CCM , FDP_ITC.2/CCM , FPT_FLS.1/CCM , FMT_MSA.1/SC , FMT_MSA.3/SC , FMT_SMF.1/SC , FIA_UAU.1/SC , FTP_ITC.1/SC , FCO_NRO.2/SC , FDP_IFC.2/SC , FDP_IFF.1/SC , FIA_UID.1/SC , FIA_UAU.4/SC , FDP_ACF.1/SD	Section 4.3.1
O.DOMAIN-RIGHTS	FDP_ACC.1/SD , FDP_ACF.1/SD , FMT_MSA.1/SD , FMT_MSA.3/SD , FMT_SMF.1/SD , FMT_SMR.1/SD , FMT_MSA.1/SC , FMT_MSA.3/SC , FMT_SMF.1/SC , FIA_UID.1/SC , FIA_UAU.1/SC , FIA_UAU.4/SC , FTP_ITC.1/SC , FCO_NRO.2/SC , FDP_IFC.2/SC , FDP_IFF.1/SC	Section 4.3.1
O.APPLI-AUTH	FDP_ROL.1/CCM , FPT_FLS.1/CCM , FCS_COP.1/DAP	Section 4.3.1
O.COMM_AUTH	FTP_ITC.1/SC , FMT_SMR.1/SD , FDP_IFC.2/SC , FDP_IFF.1/SC , FMT_MSA.1/SC , FMT_MSA.3/SC , FIA_UID.1/SC , FIA_UAU.1/SC	Section 4.3.1
O.COMM_INTEGRITY	FTP_ITC.1/SC , FMT_SMF.1/SC , FMT_SMR.1/SD , FDP_IFC.2/SC , FDP_IFF.1/SC , FMT_MSA.1/SC , FMT_MSA.3/SC	Section 4.3.1
O.COMM_CONFIDENTIALITY	FTP_ITC.1/SC , FMT_SMF.1/SC , FMT_SMR.1/SD , FDP_IFC.2/SC , FDP_IFF.1/SC , FMT_MSA.1/SC , FMT_MSA.3/SC	Section 4.3.1
O.SCP-SUPPORT	FPT_RCV.4/OS	Section 4.3.1

Security Objectives	Security Functional Requirements	Rationale
O.SID	FIA_ATD.1/AID , FIA_UID.2/AID , FMT_MSA.1/JCRE , FMT_MSA.3/JCRMI , FMT_MSA.1/REM_REFS , FMT_MSA.1/EXPORT , FMT_MSA.1/ADEL , FMT_MSA.3/ADEL , FMT_MSA.3/FIREWALL , FMT_MSA.1/CM , FMT_MSA.3/CM , FDP_ITC.2/Installer , FMT_SMF.1/CM , FMT_SMF.1/ADEL , FMT_SMF.1/JCRMI , FMT_MTD.1/JCRE , FMT_MTD.3/JCRE , FIA_USB.1/AID , FMT_MSA.1/JCVM , FMT_MSA.3/JCVM	Section 4.3.1
O.FIREWALL	FDP_IFC.1/JCVM , FDP_IFF.1/JCVM , FMT_SMR.1/Installer , FMT_MSA.1/CM , FMT_MSA.3/CM , FMT_SMR.1/CM , FMT_MSA.3/FIREWALL , FMT_SMR.1 , FMT_MSA.1/ADEL , FMT_MSA.3/ADEL , FMT_SMR.1/ADEL , FMT_MSA.1/EXPORT , FMT_MSA.1/REM_REFS , FMT_MSA.3/JCRMI , FMT_REV.1/JCRMI , FMT_SMR.1/JCRMI , FMT_MSA.1/JCRE , FDP_ITC.2/Installer , FDP_ACC.2/JCRMI , FDP_ACF.1/JCRMI , FDP_ACC.2/FIREWALL , FDP_ACF.1/FIREWALL , FMT_SMF.1/ADEL , FMT_SMF.1/JCRMI , FMT_SMF.1/CM , FMT_SMF.1 , FMT_MSA.2/FIREWALL_JCVM , FMT_MTD.1/JCRE , FMT_MTD.3/JCRE , FMT_MSA.1/JCVM , FMT_MSA.3/JCVM	Section 4.3.1
O.GLOBAL_ARRAYS_CONFID	FDP_IFC.1/JCVM , FDP_IFF.1/JCVM , FDP_RIP.1/bArray , FDP_RIP.1/APDU , FDP_RIP.1/ODEL , FDP_RIP.1/OBJECTS , FDP_RIP.1/ABORT , FDP_RIP.1/KEYS , FDP_RIP.1/ADEL , FDP_RIP.1/TRANSIENT	Section 4.3.1
O.GLOBAL_ARRAYS_INTEG	FDP_IFC.1/JCVM , FDP_IFF.1/JCVM	Section 4.3.1
O.NATIVE	FDP_ACF.1/FIREWALL	Section 4.3.1

Security Objectives	Security Functional Requirements	Rationale
O.KEY-MNGT	FCS_CKM.1/RSA , FCS_CKM.2/DES , FCS_CKM.3/DES , FCS_CKM.4 , FCS_COP.1/DES_CIPHER , FPR_UNO.1 , FDP_RIP.1/ODEL , FDP_RIP.1/OBJECTS , FDP_RIP.1/ABORT , FDP_RIP.1/KEYS , FDP_SDI.2 , FDP_RIP.1/ADEL , FDP_RIP.1/TRANSIENT , FCS_COP.1/RSA_CIPHER , FDP_RIP.1/bArray , FDP_RIP.1/APDU , FCS_COP.1/HMAC , FCS_CKM.1/DES , FCS_CKM.1/AES , FCS_CKM.2/AES , FCS_CKM.2/RSA , FCS_CKM.3/AES , FCS_CKM.3/RSA , FCS_COP.1/DES_MAC_COMP , FCS_COP.1/AES_MAC_COMP , FCS_COP.1/RSA_SIGN	Section 4.3.1
O.PIN-MNGT	FDP_RIP.1/ODEL , FDP_RIP.1/OBJECTS , FDP_RIP.1/APDU , FDP_RIP.1/bArray , FDP_RIP.1/ABORT , FPR_UNO.1 , FDP_RIP.1/ADEL , FDP_RIP.1/TRANSIENT , FDP_ROL.1/FIREWALL , FDP_SDI.2 , FDP_ACC.2/FIREWALL , FDP_ACF.1/FIREWALL	Section 4.3.1
O.REMOTE	FDP_ACC.2/JCRMI , FDP_ACF.1/JCRMI , FDP_IFC.1/JCRMI , FDP_IFT.1/JCRMI , FMT_MSA.1/EXPORT , FMT_MSA.1/REM_REFS , FMT_MSA.3/JCRMI , FMT_REV.1/JCRMI , FMT_SMR.1/JCRMI	Section 4.3.1
O.TRANSACTION	FDP_ROL.1/FIREWALL , FDP_RIP.1/ABORT , FDP_RIP.1/ODEL , FDP_RIP.1/APDU , FDP_RIP.1/bArray , FDP_RIP.1/KEYS , FDP_RIP.1/ADEL , FDP_RIP.1/TRANSIENT , FDP_RIP.1/OBJECTS	Section 4.3.1
O.OBJ-DELETION	FDP_RIP.1/ODEL , FPT_FLS.1/ODEL	Section 4.3.1

	Reference	D1226479	Release	1.3p <small>(Printed copy not controlled: verify the version before using)</small>
	Classification level	Public	Pages	177

Security Objectives	Security Functional Requirements	Rationale
O.DELETION	FDP_ACC.2/ADEL , FDP_ACF.1/ADEL , FDP_RIP.1/ADEL , FPT_FLS.1/ADEL , FPT_RCV.3/Installer , FMT_MSA.1/ADEL , FMT_MSA.3/ADEL , FMT_SMR.1/ADEL	Section 4.3.1
O.LOAD	FCO_NRO.2/CM , FDP_IFC.2/CM , FDP_IFF.1/CM , FDP_UIT.1/CM , FIA_UID.1/CM , FTP_ITC.1/CM	Section 4.3.1
O.INSTALL	FDP_ITC.2/Installer , FPT_RCV.3/Installer , FPT_FLS.1/Installer	Section 4.3.1
O.SCP.RECOVERY	FPT_RCV.3/OS	Section 4.3.1
O.SCP.IC	FPT_FLS.1/JCS	Section 4.3.1
O.Secure API	FPT_FLS.1/SecureAPI , FPT_ITT.1/SecureAPI , FPR_UNO.1/SecureAPI	Section 4.3.1
O.RND	FCS_RND.1	Section 4.3.1
O.JCAPI-Services	FCS_COP.1/SHA2 , FCS_COP.1/CRC	Section 4.3.1
O.REMOTE SERVICE AUDIT	FMT_MTD.1/GemActivate , FMT_SMR.1/GemActivate , FMT_SMF.1/GemActivate	Section 4.3.1
O.REMOTE SERVICE ACTIVATION	FMT_SMR.1/GemActivate , FMT_SMF.1/GemActivate , FMT_MOF.1/GemActivate , FMT_MSA.1/GemActivate	Section 4.3.1
O.EMVUtil API	FPT_ITT.1/EMVUtilAPI , FDP_SDI.1/EMVUtilAPI	Section 4.3.1

Table 14 Security Objectives and SFRs - Coverage

Security Functional Requirements	Security Objectives
FCS COP.1/DAP	O.APPLI-AUTH
FDP ITC.2/CCM	O.CARD-MANAGEMENT
FDP ROL.1/CCM	O.CARD-MANAGEMENT , O.APPLI-AUTH
FDP UIT.1/CCM	O.CARD-MANAGEMENT
FPT FLS.1/CCM	O.CARD-MANAGEMENT , O.APPLI-AUTH
FDP ACC.1/SD	O.CARD-MANAGEMENT , O.DOMAIN-RIGHTS
FDP ACF.1/SD	O.CARD-MANAGEMENT , O.DOMAIN-RIGHTS
FMT MSA.1/SD	O.CARD-MANAGEMENT , O.DOMAIN-RIGHTS
FMT MSA.3/SD	O.CARD-MANAGEMENT , O.DOMAIN-RIGHTS
FMT SMF.1/SD	O.CARD-MANAGEMENT , O.DOMAIN-RIGHTS
FMT SMR.1/SD	O.CARD-MANAGEMENT , O.DOMAIN-RIGHTS , O.COMM AUTH , O.COMM INTEGRITY , O.COMM CONFIDENTIALITY
FCO NRO.2/SC	O.CARD-MANAGEMENT , O.DOMAIN-RIGHTS
FDP IFC.2/SC	O.CARD-MANAGEMENT , O.DOMAIN-RIGHTS , O.COMM AUTH , O.COMM INTEGRITY , O.COMM CONFIDENTIALITY
FDP IFF.1/SC	O.CARD-MANAGEMENT , O.DOMAIN-RIGHTS , O.COMM AUTH , O.COMM INTEGRITY , O.COMM CONFIDENTIALITY
FIA UID.1/SC	O.CARD-MANAGEMENT , O.DOMAIN-RIGHTS , O.COMM AUTH
FIA UAU.1/SC	O.CARD-MANAGEMENT , O.DOMAIN-RIGHTS , O.COMM AUTH
FIA UAU.4/SC	O.CARD-MANAGEMENT , O.DOMAIN-RIGHTS
FMT MSA.1/SC	O.CARD-MANAGEMENT , O.DOMAIN-RIGHTS , O.COMM AUTH , O.COMM INTEGRITY , O.COMM CONFIDENTIALITY
FMT MSA.3/SC	O.CARD-MANAGEMENT , O.DOMAIN-RIGHTS , O.COMM AUTH , O.COMM INTEGRITY , O.COMM CONFIDENTIALITY

Security Functional Requirements	Security Objectives
FMT_SMF.1/SC	O.CARD-MANAGEMENT , O.DOMAIN-RIGHTS , O.COMM INTEGRITY , O.COMM CONFIDENTIALITY
FTP_ITC.1/SC	O.CARD-MANAGEMENT , O.DOMAIN-RIGHTS , O.COMM AUTH , O.COMM INTEGRITY , O.COMM CONFIDENTIALITY
FDP_ACC.2/FIREWALL	O.FIREWALL , O.OPERATE , O.PIN-MNGT
FDP_ACF.1/FIREWALL	O.FIREWALL , O.NATIVE , O.OPERATE , O.PIN-MNGT
FDP_IFC.1/JCVM	O.FIREWALL , O.GLOBAL ARRAYS CONFID , O.GLOBAL ARRAYS INTEG
FDP_IFF.1/JCVM	O.FIREWALL , O.GLOBAL ARRAYS CONFID , O.GLOBAL ARRAYS INTEG
FDP_RIP.1/OBJECTS	O.GLOBAL ARRAYS CONFID , O.REALLOCATION , O.KEY-MNGT , O.PIN-MNGT , O.TRANSACTION
FMT_MSA.1/JCRE	O.SID , O.FIREWALL
FMT_MSA.1/JCVM	O.SID , O.FIREWALL
FMT_MSA.2/FIREWALL_JCVM	O.FIREWALL
FMT_MSA.3/FIREWALL	O.SID , O.FIREWALL
FMT_MSA.3/JCVM	O.SID , O.FIREWALL
FMT_SMF.1	O.FIREWALL , O.RESOURCES
FMT_SMR.1	O.FIREWALL , O.RESOURCES
FCS_CKM.1/DES	O.CIPHER , O.KEY-MNGT
FCS_CKM.1/AES	O.CIPHER , O.KEY-MNGT
FCS_CKM.1/RSA	O.CIPHER , O.KEY-MNGT
FCS_CKM.2/DES	O.CIPHER , O.KEY-MNGT
FCS_CKM.2/AES	O.CIPHER , O.KEY-MNGT
FCS_CKM.2/RSA	O.CIPHER , O.KEY-MNGT
FCS_CKM.3/DES	O.CIPHER , O.KEY-MNGT
FCS_CKM.3/AES	O.CIPHER , O.KEY-MNGT
FCS_CKM.3/RSA	O.CIPHER , O.KEY-MNGT
FCS_CKM.4	O.CIPHER , O.KEY-MNGT

Security Functional Requirements	Security Objectives
FCS COP.1/DES CIPHER	O.CIPHER , O.KEY-MNGT
FCS COP.1/DES MAC COMP	O.KEY-MNGT
FCS COP.1/AES CIPHER	O.CIPHER
FCS COP.1/AES MAC COMP	O.KEY-MNGT
FCS COP.1/RSA SIGN	O.KEY-MNGT
FCS COP.1/RSA CIPHER	O.CIPHER , O.KEY-MNGT
FCS COP.1/HMAC	O.KEY-MNGT
FDP RIP.1/ABORT	O.GLOBAL_ARRAYS_CONFID , O.REALLOCATION , O.KEY-MNGT , O.PIN-MNGT , O.TRANSACTION
FDP RIP.1/APDU	O.GLOBAL_ARRAYS_CONFID , O.REALLOCATION , O.KEY-MNGT , O.PIN-MNGT , O.TRANSACTION
FDP RIP.1/bArray	O.GLOBAL_ARRAYS_CONFID , O.REALLOCATION , O.KEY-MNGT , O.PIN-MNGT , O.TRANSACTION
FDP RIP.1/KEYS	O.GLOBAL_ARRAYS_CONFID , O.REALLOCATION , O.KEY-MNGT , O.TRANSACTION
FDP RIP.1/TRANSIENT	O.GLOBAL_ARRAYS_CONFID , O.REALLOCATION , O.KEY-MNGT , O.PIN-MNGT , O.TRANSACTION
FDP ROL.1/FIREWALL	O.OPERATE , O.RESOURCES , O.PIN-MNGT , O.TRANSACTION
FAU ARP.1	O.OPERATE , O.RESOURCES , O.ALARM
FDP SDI.2	O.KEY-MNGT , O.PIN-MNGT
FPR UNO.1	O.CIPHER , O.KEY-MNGT , O.PIN-MNGT
FPT FLS.1/JCS	O.OPERATE , O.RESOURCES , O.ALARM , O.SCP.IC
FPT TDC.1	O.OPERATE
FIA ATD.1/AID	O.SID , O.OPERATE
FIA UID.2/AID	O.SID
FIA USB.1/AID	O.SID , O.OPERATE
FMT MTD.1/JCRE	O.SID , O.FIREWALL , O.RESOURCES
FMT MTD.3/JCRE	O.SID , O.FIREWALL , O.RESOURCES

Security Functional Requirements	Security Objectives
FDP_ITC.2/Installer	O.SID , O.FIREWALL , O.OPERATE , O.INSTALL
FMT_SMR.1/Installer	O.FIREWALL , O.RESOURCES
FPT_FLS.1/Installer	O.OPERATE , O.RESOURCES , O.ALARM , O.INSTALL
FPT_RCV.3/Installer	O.OPERATE , O.RESOURCES , O.DELETION , O.INSTALL
FDP_ACC.2/ADEL	O.DELETION
FDP_ACF.1/ADEL	O.DELETION
FDP_RIP.1/ADEL	O.GLOBAL_ARRAYS_CONFID , O.REALLOCATION , O.KEY-MNGT , O.PIN-MNGT , O.TRANSACTION , O.DELETION
FMT_MSA.1/ADEL	O.SID , O.FIREWALL , O.DELETION
FMT_MSA.3/ADEL	O.SID , O.FIREWALL , O.DELETION
FMT_SMF.1/ADEL	O.SID , O.FIREWALL , O.RESOURCES
FMT_SMR.1/ADEL	O.FIREWALL , O.RESOURCES , O.DELETION
FPT_FLS.1/ADEL	O.OPERATE , O.RESOURCES , O.ALARM , O.DELETION
FDP_ACC.2/JCRMI	O.FIREWALL , O.REMOTE
FDP_ACF.1/JCRMI	O.FIREWALL , O.REMOTE
FDP_IFC.1/JCRMI	O.REMOTE
FDP_IFF.1/JCRMI	O.REMOTE
FMT_MSA.1/EXPORT	O.SID , O.FIREWALL , O.REMOTE
FMT_MSA.1/REM_REFS	O.SID , O.FIREWALL , O.REMOTE
FMT_MSA.3/JCRMI	O.SID , O.FIREWALL , O.REMOTE
FMT_REV.1/JCRMI	O.FIREWALL , O.REMOTE
FMT_SMF.1/JCRMI	O.SID , O.FIREWALL , O.RESOURCES
FMT_SMR.1/JCRMI	O.FIREWALL , O.RESOURCES , O.REMOTE
FDP_RIP.1/ODEL	O.GLOBAL_ARRAYS_CONFID , O.REALLOCATION , O.KEY-MNGT , O.PIN-MNGT , O.TRANSACTION , O.OBJ-DELETION
FPT_FLS.1/ODEL	O.OPERATE , O.RESOURCES , O.ALARM , O.OBJ-DELETION
FCO_NRO.2/CM	O.LOAD

	Reference	D1226479	Release	1.3p <small>(Printed copy not controlled: verify the version before using)</small>
	Classification level	Public	Pages	177

Security Functional Requirements	Security Objectives
FDP_IFC.2/CM	O.LOAD
FDP_IFF.1/CM	O.LOAD
FDP_UIT.1/CM	O.LOAD
FIA_UID.1/CM	O.LOAD
FMT_MSA.1/CM	O.SID, O.FIREWALL
FMT_MSA.3/CM	O.SID, O.FIREWALL
FMT_SMF.1/CM	O.SID, O.FIREWALL, O.RESOURCES
FMT_SMR.1/CM	O.FIREWALL, O.RESOURCES
FTP_ITC.1/CM	O.LOAD
FPT_RCV.3/OS	O.SCP.RECOVERY
FPT_RCV.4/OS	O.SCP-SUPPORT
FCS_COP.1/SHA2	O.JCAPI-Services
FCS_COP.1/CRC	O.JCAPI-Services
FCS_RND.1	O.RND
FPT_FLS.1/SecureAPI	O.Secure_API
FPT_ITT.1/SecureAPI	O.Secure_API
FPR_UNO.1/SecureAPI	O.Secure_API
FMT_SMR.1/GemActivate	O.REMOTE SERVICE AUDIT, O.REMOTE SERVICE ACTIVATION
FMT_SMF.1/GemActivate	O.REMOTE SERVICE AUDIT, O.REMOTE SERVICE ACTIVATION
FMT_MOF.1/GemActivate	O.REMOTE SERVICE ACTIVATION
FMT_MSA.1/GemActivate	O.REMOTE SERVICE ACTIVATION
FMT_MTD.1/GemActivate	O.REMOTE SERVICE AUDIT
FPT_ITT.1/EMVUtilAPI	O.EMVUtil_API
FDP_SDI.1/EMVUtilAPI	O.EMVUtil_API

Table 15 SFRs and Security Objectives

	Reference	D1226479	Release	1.3p <small>(Printed copy not controlled: verify the version before using)</small>
	Classification level	Public	Pages	177

6.3.3 Dependencies

6.3.3.1 SFRs dependencies

Requirements	CC Dependencies	Satisfied Dependencies
FDP_ITC.2/Installer	(FDP_ACC.1 or FDP_IFC.1) and (FPT_TDC.1) and (FTP_ITC.1 or FTP_TRP.1)	FDP_IFC.2/CM , FTP_ITC.1/CM , FPT_TDC.1
FMT_SMR.1/Installer	(FIA_UID.1)	
FPT_FLS.1/Installer	No dependencies	
FPT_RCV.3/Installer	(AGD_OPE.1)	AGD_OPE.1
FDP_ACC.2/ADEL	(FDP_ACF.1)	FDP_ACF.1/ADEL
FDP_ACF.1/ADEL	(FDP_ACC.1) and (FMT_MSA.3)	FDP_ACC.2/ADEL , FMT_MSA.3/ADEL
FDP_RIP.1/ADEL	No dependencies	
FMT_MSA.1/ADEL	(FDP_ACC.1 or FDP_IFC.1) and (FMT_SMF.1) and (FMT_SMR.1)	FDP_ACC.2/ADEL , FMT_SMF.1/ADEL , FMT_SMR.1/ADEL
FMT_MSA.3/ADEL	(FMT_MSA.1) and (FMT_SMR.1)	FMT_MSA.1/ADEL , FMT_SMR.1/ADEL
FMT_SMF.1/ADEL	No dependencies	
FMT_SMR.1/ADEL	(FIA_UID.1)	
FPT_FLS.1/ADEL	No dependencies	
FDP_ACC.2/JCRMI	(FDP_ACF.1)	FDP_ACF.1/JCRMI
FDP_ACF.1/JCRMI	(FDP_ACC.1) and (FMT_MSA.3)	FDP_ACC.2/JCRMI , FMT_MSA.3/JCRMI
FDP_IFC.1/JCRMI	(FDP_IFF.1)	FDP_IFF.1/JCRMI
FDP_IFF.1/JCRMI	(FDP_IFC.1) and (FMT_MSA.3)	FDP_IFC.1/JCRMI , FMT_MSA.3/JCRMI
FMT_MSA.1/EXPORT	(FDP_ACC.1 or FDP_IFC.1) and (FMT_SMF.1) and (FMT_SMR.1)	FDP_ACC.2/JCRMI , FMT_SMF.1/JCRMI , FMT_SMR.1/JCRMI
FMT_MSA.1/REM_REFS	(FDP_ACC.1 or FDP_IFC.1) and (FMT_SMF.1) and (FMT_SMR.1)	FDP_ACC.2/JCRMI , FMT_SMF.1/JCRMI , FMT_SMR.1/JCRMI

Requirements	CC Dependencies	Satisfied Dependencies
FMT_MSA.3/JCRMI	(FMT_MSA.1) and (FMT_SMR.1)	FMT_MSA.1/EXPORT , FMT_MSA.1/REM_REFS , FMT_SMR.1/JCRMI
FMT_REV.1/JCRMI	(FMT_SMR.1)	FMT_SMR.1/JCRMI
FMT_SMF.1/JCRMI	No dependencies	
FMT_SMR.1/JCRMI	(FIA_UID.1)	FIA_UID.2/AID
FDP_RIP.1/ODEL	No dependencies	
FPT_FLS.1/ODEL	No dependencies	
FCO_NRO.2/CM	(FIA_UID.1)	FIA_UID.1/CM
FDP_IFC.2/CM	(FDP_IFF.1)	FDP_IFF.1/CM
FDP_IFF.1/CM	(FDP_IFC.1) and (FMT_MSA.3)	FDP_IFC.2/CM , FMT_MSA.3/CM
FDP_UIT.1/CM	(FDP_ACC.1 or FDP_IFC.1) and (FTP_ITC.1 or FTP_TRP.1)	FDP_IFC.2/CM , FTP_ITC.1/CM
FIA_UID.1/CM	No dependencies	
FMT_MSA.1/CM	(FDP_ACC.1 or FDP_IFC.1) and (FMT_SMF.1) and (FMT_SMR.1)	FDP_IFC.2/CM , FMT_SMF.1/CM , FMT_SMR.1/CM
FMT_MSA.3/CM	(FMT_MSA.1) and (FMT_SMR.1)	FMT_MSA.1/CM , FMT_SMR.1/CM
FMT_SMF.1/CM	No dependencies	
FMT_SMR.1/CM	(FIA_UID.1)	FIA_UID.1/CM
FTP_ITC.1/CM	No dependencies	
FCS_COP.1/SHA2	(FCS_CKM.1 or FDP_ITC.1 or FDP_ITC.2) and (FCS_CKM.4)	
FCS_COP.1/CRC	(FCS_CKM.1 or FDP_ITC.1 or FDP_ITC.2) and (FCS_CKM.4)	
FCS_RND.1	No dependencies	
FPT_FLS.1/SecureAPI	No dependencies	
FPT_ITT.1/SecureAPI	No dependencies	

Requirements	CC Dependencies	Satisfied Dependencies
FPR_UNO.1/SecureAPI	No dependencies	
FMT_SMR.1/GemActivate	(FIA_UID.1)	FIA_UID.1/CM , FIA_UID.2/AID , FIA_UID.1/SC
FMT_SMF.1/GemActivate	No dependencies	
FMT_MOF.1/GemActivate	(FMT_SMF.1) and (FMT_SMR.1)	FMT_SMR.1/GemActivate , FMT_SMF.1/GemActivate
FMT_MSA.1/GemActivate	(FDP_ACC.1 or FDP_IFC.1) and (FMT_SMF.1) and (FMT_SMR.1)	FMT_SMR.1/GemActivate , FMT_SMF.1/GemActivate
FMT_MTD.1/GemActivate	(FMT_SMF.1) and (FMT_SMR.1)	FMT_SMR.1/GemActivate , FMT_SMF.1/GemActivate
FPT_ITT.1/EMVUtilAPI	No dependencies	
FDP_SDI.1/EMVUtilAPI	No dependencies	
FDP_ACC.2/FIREWALL	(FDP_ACF.1)	FDP_ACF.1/FIREWALL
FDP_ACF.1/FIREWALL	(FDP_ACC.1) and (FMT_MSA.3)	FDP_ACC.2/FIREWALL , FMT_MSA.3/FIREWALL
FDP_IFC.1/JCVM	(FDP_IFF.1)	FDP_IFF.1/JCVM
FDP_IFF.1/JCVM	(FDP_IFC.1) and (FMT_MSA.3)	FDP_IFC.1/JCVM , FMT_MSA.3/JCVM
FDP_RIP.1/OBJECTS	No dependencies	
FMT_MSA.1/JCRE	(FDP_ACC.1 or FDP_IFC.1) and (FMT_SMF.1) and (FMT_SMR.1)	FDP_ACC.2/FIREWALL , FMT_SMR.1
FMT_MSA.1/JCVM	(FDP_ACC.1 or FDP_IFC.1) and (FMT_SMF.1) and (FMT_SMR.1)	FDP_ACC.2/FIREWALL , FDP_IFC.1/JCVM , FMT_SMF.1 , FMT_SMR.1
FMT_MSA.2/FIREWALL JCVM	(FDP_ACC.1 or FDP_IFC.1) and (FMT_MSA.1) and (FMT_SMR.1)	FDP_ACC.2/FIREWALL , FDP_IFC.1/JCVM , FMT_MSA.1/JCRE , FMT_MSA.1/JCVM , FMT_SMR.1
FMT_MSA.3/FIREWALL	(FMT_MSA.1) and (FMT_SMR.1)	FMT_MSA.1/JCRE , FMT_MSA.1/JCVM , FMT_SMR.1
FMT_MSA.3/JCVM	(FMT_MSA.1) and (FMT_SMR.1)	FMT_MSA.1/JCVM , FMT_SMR.1
FMT_SMF.1	No dependencies	

Requirements	CC Dependencies	Satisfied Dependencies
FMT_SMR.1	(FIA_UID.1)	FIA_UID.2/AID
FCS_CKM.1/DES	(FCS_CKM.2 or FCS_COP.1) and (FCS_CKM.4)	FCS_CKM.2/DES , FCS_CKM.4
FCS_CKM.1/AES	(FCS_CKM.2 or FCS_COP.1) and (FCS_CKM.4)	FCS_CKM.4 , FCS_COP.1/AES_CIPHER
FCS_CKM.1/RSA	(FCS_CKM.2 or FCS_COP.1) and (FCS_CKM.4)	FCS_CKM.4 , FCS_COP.1/RSA_SIGN , FCS_COP.1/RSA_CIPHER
FCS_CKM.2/DES	(FCS_CKM.1 or FDP_ITC.1 or FDP_ITC.2) and (FCS_CKM.4)	FCS_CKM.1/DES , FCS_CKM.4
FCS_CKM.2/AES	(FCS_CKM.1 or FDP_ITC.1 or FDP_ITC.2) and (FCS_CKM.4)	FCS_CKM.1/AES , FCS_CKM.4
FCS_CKM.2/RSA	(FCS_CKM.1 or FDP_ITC.1 or FDP_ITC.2) and (FCS_CKM.4)	FCS_CKM.1/RSA , FCS_CKM.4
FCS_CKM.3/DES	(FCS_CKM.1 or FDP_ITC.1 or FDP_ITC.2) and (FCS_CKM.4)	FCS_CKM.1/DES , FCS_CKM.4
FCS_CKM.3/AES	(FCS_CKM.1 or FDP_ITC.1 or FDP_ITC.2) and (FCS_CKM.4)	FCS_CKM.1/AES , FCS_CKM.4
FCS_CKM.3/RSA	(FCS_CKM.1 or FDP_ITC.1 or FDP_ITC.2) and (FCS_CKM.4)	FCS_CKM.1/RSA , FCS_CKM.4
FCS_CKM.4	(FCS_CKM.1 or FDP_ITC.1 or FDP_ITC.2)	FCS_CKM.1/RSA
FCS_COP.1/DES_CIPHER	(FCS_CKM.1 or FDP_ITC.1 or FDP_ITC.2) and (FCS_CKM.4)	FCS_CKM.1/DES , FCS_CKM.4

Requirements	CC Dependencies	Satisfied Dependencies
FCS COP.1/DES MAC COMP	(FCS_CKM.1 or FDP_ITC.1 or FDP_ITC.2) and (FCS_CKM.4)	FCS_CKM.1/DES , FCS_CKM.4
FCS COP.1/AES CIPHER	(FCS_CKM.1 or FDP_ITC.1 or FDP_ITC.2) and (FCS_CKM.4)	FCS_CKM.1/AES , FCS_CKM.4
FCS COP.1/AES MAC COMP	(FCS_CKM.1 or FDP_ITC.1 or FDP_ITC.2) and (FCS_CKM.4)	FCS_CKM.1/AES , FCS_CKM.4
FCS COP.1/RSA SIGN	(FCS_CKM.1 or FDP_ITC.1 or FDP_ITC.2) and (FCS_CKM.4)	FCS_CKM.1/RSA , FCS_CKM.4
FCS COP.1/RSA CIPHER	(FCS_CKM.1 or FDP_ITC.1 or FDP_ITC.2) and (FCS_CKM.4)	FCS_CKM.1/RSA , FCS_CKM.4
FCS COP.1/HMAC	(FCS_CKM.1 or FDP_ITC.1 or FDP_ITC.2) and (FCS_CKM.4)	FCS_CKM.1/DES , FCS_CKM.1/AES , FCS_CKM.4
FDP RIP.1/ABORT	No dependencies	
FDP RIP.1/APDU	No dependencies	
FDP RIP.1/bArray	No dependencies	
FDP RIP.1/KEYS	No dependencies	
FDP RIP.1/TRANSIENT	No dependencies	
FDP ROL.1/FIREWALL	(FDP_ACC.1 or FDP_IFC.1)	FDP_ACC.2/FIREWALL , FDP_IFC.1/JCVM
FAU ARP.1	(FAU_SAA.1)	
FDP SDI.2	No dependencies	
FPR UNO.1	No dependencies	
FPT FLS.1/JCS	No dependencies	
FPT TDC.1	No dependencies	
FIA ATD.1/AID	No dependencies	
FIA UID.2/AID	No dependencies	

Requirements	CC Dependencies	Satisfied Dependencies
FIA_USB.1/AID	(FIA_ATD.1)	FIA_ATD.1/AID
FMT_MTD.1/JCRE	(FMT_SMF.1) and (FMT_SMR.1)	FMT_SMF.1 , FMT_SMR.1
FMT_MTD.3/JCRE	(FMT_MTD.1)	FMT_MTD.1/JCRE
FPT_RCV.3/OS	(AGD_OPE.1)	AGD_OPE.1
FPT_RCV.4/OS	No dependencies	
FCS_COP.1/DAP	(FCS_CKM.1 or FDP_ITC.1 or FDP_ITC.2) and (FCS_CKM.4)	FCS_CKM.4 , FDP_ITC.2/CCM
FDP_ITC.2/CCM	(FDP_ACC.1 or FDP_IFC.1) and (FPT_TDC.1) and (FTP_ITC.1 or FTP_TRP.1)	FDP_ACC.1/SD , FTP_ITC.1/SC
FDP_ROL.1/CCM	(FDP_ACC.1 or FDP_IFC.1)	FDP_ACC.1/SD
FDP_UIT.1/CCM	(FDP_ACC.1 or FDP_IFC.1) and (FTP_ITC.1 or FTP_TRP.1)	FDP_ACC.1/SD , FTP_ITC.1/SC
FPT_FLS.1/CCM	No dependencies	
FDP_ACC.1/SD	(FDP_ACF.1)	FDP_ACF.1/SD
FDP_ACF.1/SD	(FDP_ACC.1) and (FMT_MSA.3)	FDP_ACC.1/SD , FMT_MSA.3/SD
FMT_MSA.1/SD	(FDP_ACC.1 or FDP_IFC.1) and (FMT_SMF.1) and (FMT_SMR.1)	FDP_ACC.1/SD , FMT_SMF.1/SD , FMT_SMR.1/SD
FMT_MSA.3/SD	(FMT_MSA.1) and (FMT_SMR.1)	FMT_MSA.1/SD , FMT_SMR.1/SD
FMT_SMF.1/SD	No dependencies	
FMT_SMR.1/SD	(FIA_UID.1)	FIA_UID.1/SC
FCO_NRO.2/SC	(FIA_UID.1)	FIA_UID.1/SC
FDP_IFC.2/SC	(FDP_IFF.1)	FDP_IFF.1/SC
FDP_IFF.1/SC	(FDP_IFC.1) and (FMT_MSA.3)	FDP_IFC.2/SC , FMT_MSA.3/SC

	Reference	D1226479	Release	1.3p <small>(Printed copy not controlled: verify the version before using)</small>
	Classification level	Public	Pages	177

Requirements	CC Dependencies	Satisfied Dependencies
FIA_UID.1/SC	No dependencies	
FIA_UAU.1/SC	(FIA_UID.1)	FIA_UID.1/SC
FIA_UAU.4/SC	No dependencies	
FMT_MSA.1/SC	(FDP_ACC.1 or FDP_IFC.1) and (FMT_SMF.1) and (FMT_SMR.1)	FDP_ACC.1/SD , FMT_SMR.1/SD , FMT_SMF.1/SC
FMT_MSA.3/SC	(FMT_MSA.1) and (FMT_SMR.1)	FMT_SMR.1/SD , FMT_MSA.1/SC
FMT_SMF.1/SC	No dependencies	
FTP_ITC.1/SC	No dependencies	

Table 16 SFRs dependencies

	Reference	D1226479	Release	1.3p <small>(Printed copy not controlled: verify the version before using)</small>
	Classification level	Public	Pages	177

Rationale for the exclusion of dependencies

The dependency FIA_UID.1 of FMT_SMR.1/Installer is unsupported. This PP does not require the identification of the "installer" since it can be considered as part of the TSF.

The dependency FIA_UID.1 of FMT_SMR.1/ADEL is unsupported. This PP does not require the identification of the "deletion manager" since it can be considered as part of the TSF.

The dependency FCS_CKM.4 of FCS_COP.1/SHA2 is unsupported. Hash operation according to SHA2 do not require key.

The dependency FCS_CKM.1 or FDP_ITC.1 or FDP_ITC.2 of FCS_COP.1/SHA2 is unsupported. Hash operation according to SHA2 do not require key.

The dependency FCS_CKM.4 of FCS_COP.1/CRC is unsupported. CRC operations do not require any key.

The dependency FCS_CKM.1 or FDP_ITC.1 or FDP_ITC.2 of FCS_COP.1/CRC is unsupported. CRC operations do not require any key.

The dependency FDP_ACC.1 or FDP_IFC.1 of FMT_MSA.1/GemActivate is unsupported. GemActivate Access Control policy is dedicated to TOE services linked to TSF data, therefore no user data is used requiring link to FDP family.

The dependency FMT_SMF.1 of FMT_MSA.1/JCRE is unsupported. The dependency between FMT_MSA.1/JCRE and FMT_SMF.1 is not satisfied because no management functions are required for the Java Card RE.

The dependency FAU_SAA.1 of FAU_ARP.1 is unsupported. The dependency of FAU_ARP.1 on FAU_SAA.1 assumes that a "potential security violation" generates an audit event. On the contrary, the events listed in FAU_ARP.1 are self-contained (arithmetic exception, ill-formed bytecodes, access failure) and ask for a straightforward reaction of the TSFs on their occurrence at runtime. The JCVM or other components of the TOE detect these events during their usual working order. Thus, there is no mandatory audit recording in this PP.

The dependency FPT_TDC.1 of FDP_ITC.2/CCM is unsupported. See PP.

6.3.3.2 SARs dependencies

Requirements	CC Dependencies	Satisfied Dependencies
ALC_DVS.2	No dependencies	

Requirements	CC Dependencies	Satisfied Dependencies
AVA VAN.5	(ADV_ARC.1) and (ADV_FSP.4) and (ADV_IMP.1) and (ADV_TDS.3) and (AGD_OPE.1) and (AGD_PRE.1) and (ATE_DPT.1)	ADV_ARC.1 , ADV_FSP.4 , ADV_IMP.1 , ADV_TDS.3 , AGD_OPE.1 , AGD_PRE.1 , ATE_DPT.1
ADV_ARC.1	(ADV_FSP.1) and (ADV_TDS.1)	ADV_FSP.4 , ADV_TDS.3
ADV_FSP.4	(ADV_TDS.1)	ADV_TDS.3
ADV_IMP.1	(ADV_TDS.3) and (ALC_TAT.1)	ADV_TDS.3 , ALC_TAT.1
ADV_TDS.3	(ADV_FSP.4)	ADV_FSP.4
AGD_OPE.1	(ADV_FSP.1)	ADV_FSP.4
AGD_PRE.1	No dependencies	
ALC_CMC.4	(ALC_CMS.1) and (ALC_DVS.1) and (ALC_LCD.1)	ALC_DVS.2 , ALC_CMS.4 , ALC_LCD.1
ALC_CMS.4	No dependencies	
ALC_DEL.1	No dependencies	
ALC_LCD.1	No dependencies	
ALC_TAT.1	(ADV_IMP.1)	ADV_IMP.1
ASE_CCL.1	(ASE_ECD.1) and (ASE_INT.1) and (ASE_REQ.1)	ASE_ECD.1 , ASE_INT.1 , ASE_REQ.2
ASE_ECD.1	No dependencies	
ASE_INT.1	No dependencies	
ASE_OBJ.2	(ASE_SPD.1)	ASE_SPD.1
ASE_REQ.2	(ASE_ECD.1) and (ASE_OBJ.2)	ASE_ECD.1 , ASE_OBJ.2
ASE_SPD.1	No dependencies	
ASE_TSS.1	(ADV_FSP.1) and (ASE_INT.1) and (ASE_REQ.1)	ADV_FSP.4 , ASE_INT.1 , ASE_REQ.2
ATE_COV.2	(ADV_FSP.2) and (ATE_FUN.1)	ADV_FSP.4 , ATE_FUN.1
ATE_DPT.1	(ADV_ARC.1) and (ADV_TDS.2) and (ATE_FUN.1)	ADV_ARC.1 , ADV_TDS.3 , ATE_FUN.1
ATE_FUN.1	(ATE_COV.1)	ATE_COV.2
ATE_IND.2	(ADV_FSP.2) and (AGD_OPE.1) and (AGD_PRE.1) and (ATE_COV.1) and (ATE_FUN.1)	ADV_FSP.4 , AGD_OPE.1 , AGD_PRE.1 , ATE_COV.2 , ATE_FUN.1

Table 17 SARs dependencies

	Reference	D1226479	Release	1.3p <small>(Printed copy not controlled: verify the version before using)</small>
	Classification level	Public	Pages	177

7 TOE Summary Specification

7.1 TOE Summary Specification

7.1.1 Basic TOE

7.1.1.1 GP

GP.CardContentManagement

This security function provides the capability and a dedicated flow control for the loading, installation, extradition, registry update, selection and removal of card content and especially executable files and application instances.

Such features are offered to the Card Issuer and its business partners, allowing the Card Issuer to delegate card content management to an Application Provider according to privileges assigned to the various security domains on the card.

It supports delegated management and it can use DAP or Mandated DAP verification and generation of Reception token.

It also checks that only the card management commands specified and allowed at each state of the smart card's life cycle are accepted, and ill-formed ones are rejected with an appropriate error response.

GP.SecurityDomain

This security function provides security domain management: as SD creation, SD selection, SD privileges setting, SD deletion in SD hierarchy. It provides means to associate or extradite an application to a security domain in order to provide services (as secure channel) to the dedicated application without sharing the related keys stored in SD. It also provides Keyset Management in SD, with Key Set creation, Key set deletion, key importation, replacement, or deletion in Key Set.

Security Domains are privileged Applications as defined in [GP2.2.2 § 7], holding cryptographic keys to be used to support Secure Channel Protocol operations and/or to authorize card content management functions. There are different types of security domain with dedicated privileges and associated operations: ISD Security domain, Supplementary Security domains, and Controlling Authority Security domains.

ISD Security domain as defined in [GP2.2.2 §7.1], is the mandatory Security Domain, implicitly selected if the Application implicitly selectable on the same logical channel of the same card I/O interface is removed. It inherits of the Final Application privilege if the Application with that privilege is removed.

Supplementary Security Domains are privileged Applications with dedicated privileges:

- Token Verification Privilege as described in [GP22 §9.1.3.1]

- Delegated Management Privilege as described in [GP22 §9.1.3.3]

- Global Delete Privilege as described in [GP22 §9.1.3.4]

- Global Lock Privilege as described in [GP22 §9.1.3.5]

- Receipt Generation Privilege as described in [GP22 §9.1.3.6]

Controlling Authority Security Domain is a supplementary Security Domain dedicated to the Controlling Authority with dedicated privileges. It contains Security Domains

	Reference D1226479	Release 1.3p <small>(Printed copy not controlled: verify the version before using)</small>
	Classification level Public	Pages 177

JCS.Exception

This security function manages throwing of an instance of Exception class in the following cases:

- a SecurityException when an illegal access to an object is detected,
- a SystemException with an error code describing the error condition,
- a RemoteException when a communication-related exception has occurred during the execution of a remote method call,
- a CryptoException in case of algorithm error or illegal use,
- any exception decided by the applet or the JCRE handled as temporary JCRE entry point object with associated JC API. It also offers a means to applet to handle exception and to JCRE to handle uncaught exception by applets.

JCS.Firewall

This security function enforces the Firewall access control policy and the JVM information flow control policy at runtime. It defines how accessing the following items: Static Class Fields, Array Objects, Class Instance Object Fields, Class Instance Object Methods, Standard Interface Methods, Shareable Interface Methods, Classes, Standard Interfaces, Shareable Interfaces, Array Object Methods.

Based on security attributes [Sharing, Context, Lifetime], it performs access control to object fields between objects and throws security exception when access is denied. Thus, it enforces applet isolation located in different packages and controls the access to global data containers shared by all applet instances.

The JCRE shall allocate and manage a context for each Java API package containing applets. The JCRE maintains its own context a special system privileges so that it can perform operations that are denied to contexts of applets.

JCS.KeyManagement

This security function enforces key management for the different associated operations: key building, key agreement, key generation, key importation, key exportation, key masking, key destruction using standard API defined in [JCAPI].

Key generation support generation of RSA key pairs using a secure random number generator compliant with ANSSI's Standard security level for cryptography operations.

Key agreement enables an applet to agree on a shared secret with the external, with a method conformant to [JCAPI]. It is built to avoid disclosure of this secret to third parties observing exchange done for key agreement.

Key masking protects the confidentiality of cryptographic keys from being read out from the memory. It ensures the service of accessing and modifying them.

Key destruction disables the use of a key both logically and physically. Reuse is only possible after erase.

Key importation and exportation is done using method protecting confidentiality and integrity of key.

JCS.OutOfLifeDataUndisclosure

This security function ensures that sensitive data are locked until postponed erasure on the following operations:

	Reference	D1226479	Release	1.3p <small>(Printed copy not controlled: verify the version before using)</small>
	Classification level	Public	Pages	177

JCRE throw exception,
JCRE security reaction.

7.1.1.3 SecureAPI

SA.FlowControl

The security function provides means to application to control execution flow, to detect any failure and to react if required.

SA.SecureOperation

The security function provides means to application to execute securely data transfer and comparison, to detect any failure during operation and to react if required.

SA.RandomDelay

The security function provides means to introduce dummy operations leading to unobservability of sensitive operation.

7.1.1.4 EMVUtil_API

EUA.SecureContainer

The security function provides means to application to perform read/write operations on dedicated secure container and to check the integrity of the data stored in it.

EUA.SecureCounter

The security function provides means to application to manage securely operations associated to counter object and to check its integrity.

7.1.1.5 GemActivate

GA.OptionalServiceActivation

Activation is only possible for deactivated services defined in registry. Activation is done by changing internal state of optional platform service: cryptographic algorithm, package, applet instance, scalability (extension of available NVM) and NFC interface (SWP, HCI gate). The command is available only for GemActivate under control of GemActivate Administrator. GemActivate is accessible only using a secure channel under control of MNO.

GA.ServiceAudit

The application allow MNO or GemActivate administrator audit of actual state (deactivated, activated, inhibited) of each optional platform service described in platform registry.

GA.GemActivateActivation

The application can be activated by GemActivate Administrator only if the following conditions are fulfilled:

if activation command is consistent,

	Reference D1226479	Release 1.3p <small>(Printed copy not controlled: verify the version before using)</small>
	Classification level Public	Pages 177

7.2 SFRs and TSS

7.2.1 SFRs and TSS - Rationale

Chapter content has been removed in Public version.

7.2.2 Association tables of SFRs and TSS

Chapter content has been removed in Public version.

	Reference D1226479	Release 1.3p <small>(Printed copy not controlled: verify the version before using)</small>
	Classification level Public	Pages 177

8 Notice

This document has been generated with TL SET version 2.3.7 (for CC3). For more information about the security editor tool of Trusted Labs visit our website at www.trusted-labs.com.

	Reference	D1226479	Release	1.3p <small>(Printed copy not controlled: verify the version before using)</small>
	Classification level	Public	Pages	177

9 References, Glossary and Abbreviations

9.1 External References

Reference	Title
[CC-1]	Common Criteria for Information Technology Security Evaluation Part 1: Introduction and general model CCIMB-2009-07-001, version 3.1 Release 3, July 2009.
[CC-2]	Common Criteria for Information Technology Security Evaluation Part 2: Security Functional Requirements CCIMB-2009-07-002, version 3.1 Release 3, July 2009.
[CC-3]	Common Criteria for Information Technology security Evaluation Part 3: Security Assurance Requirements CCIMB-2009-07-003, version 3.1 Release 3, July 2009.
[CEM]	Common Methodology for Information Technology Security Evaluation CCIMB-2009-07-004, version 3.1 Release 3, July 2009.
[Comp]	CCDB, Composite product evaluation for Smart Cards and similar devices, September 2007, Version 1.0 - Revision 1, September 2007, CCDB-2007-09-001
[DCSSI2741]	Règles et recommandations concernant le choix et le dimensionnement des mécanismes cryptographiques de niveau de robustesse standard N° 2741/SGDN/DCSSI/SDS/LCR Version 1.10
[FIPS 46-3]	FIPS 46-3: DES Data Encryption Standard (DES and TDES). National Institute of Standards and Technology
[FIPS 197]	FIPS 197: AES Advanced Encryption Standard. National Institute of Standards and Technology.
[FIPS 180-2]	FIPS-46-3: Secure Hash Standard (SHA). National Institute of Standards and Technology.
[GP22]	Global Platform 2.2.2, Specification GP
[GP-CCCM]	GlobalPlatform, Card Confidential Card Content Management, Card specification v2.2 – Amendment A,
[GP-UICC]	GlobalPlatform Card UICC Configuration Version 1.0
[ISO 7816-4]	Identification cards - Integrated circuit(s) cards with contacts, Part 4: Interindustry commands for interchange.
[ISO 7816-6]	Identification cards - Integrated circuit(s) cards with contacts, Part 6: Interindustry data elements.
[ISO 7816-9]	Identification cards - Integrated circuit(s) cards with contacts, Part 9: Additional Inter industry commands and security attributes.
[ISO 9796-2]	ISO/IEC 9796-2 Information technology -- Security techniques -- Digital signature schemes giving message recovery -- Part 2: Integer factorization based mechanisms
[JCAPI222]	Java Card™ APIs specification version 2.2.2, Sun Microsystems, Inc, March 2006.
[JCRE222]	Java Card™ Runtime Environment Specification version 2.2.2, Sun Microsystems, Inc, March 2006
[JCVM222]	Java Card 2.2.2 Virtual Machine Specification, Sun Microsystems, March 2006
[JCRE301]	Runtime Environment Specification Java Card™ Platform, Version 3.0.1, Classic Edition, May 2009
[JCVM301]	Virtual Machine Specification Java Card™ Platform, Version 3.0.1, Classic Edition, May 2009

	Reference	D1226479	Release	1.3p <small>(Printed copy not controlled: verify the version before using)</small>
	Classification level	Public	Pages	177

Reference	Title
[JIL]	Joint Interpretation Library Composite product evaluation for Smart Cards and similar devices Version 1.0 September 2007
[PP-BSI-0035]	Security IC Platform Protection Profile Version 1.0 15.06.2007
[PP-JCS]	Java Card™ System Protection Profile “Open Configuration” Version 2.6
[PP-USIM]	(U)SIM Java Card Platform Protection Profile Basic Configuration V2.0.2, June 2010
[PP-USIMb]	(U)SIM Java Card Platform Protection Profile in SCWS Configuration V2.0.2, June 2010
[PP-SSCD]	Protection profiles for Secure signature creation device — Part 2: Device with key generation
[RFC2085]	HMAC-MD5 IP Authentication with Replay Prevention
[RFC2104]	HMAC: Keyed-Hashing for Message Authentication
[RSA PKCS#1]	PKCS #1 v2.1: RSA Cryptography Standard
[ST/IC]	Security Target of ST33F1M SMD_ST33F1M_ST_10_001 Rev 01.00
[STM_SG]	ST33F1M Security Guidance
[TS03.19]	ETSI 3GPP TS 03.19, Subscriber Identity Module Application Programming Interface (SIM API) for Java Card™; Stage 2
[TS 51.011]	ETSI 3GPP TS 51.011, 3rd Generation Partnership Project; Technical Specification Group Core Network and Terminals; Specification of the Subscriber Identity Module - Mobile Equipment (SIM - ME) interface (Release 4)
[TS 51.013]	ETSI 3GPP TS 51.013, 3rd Generation Partnership Project; Technical Specification Group Terminals; Test specification for SIM API for Java Card™ (Release 4)
[TS 51.014]	ETSI 3GPP TS 51.014, 3rd Generation Partnership Project; Technical Specification Group Core Network and Terminals; Specification of the SIM Application Toolkit for the Subscriber Identity Module - Mobile Equipment (SIM - ME) interface (Release 4)
[TS 102.221]	ETSI 3GPP TS 102.221, Smart cards; UICC-Terminal interface; Physical and logical characteristics (Release 6)
[TS 102.222]	ETSI 3GPP TS 102.222, Integrated Circuit Cards (ICC); Administrative commands for telecommunications applications (Release 6) – v 6.0.0 (2003-02).
[TS 102.223]	ETSI 3GPP TS 102.223, Smart Cards; Card Application Toolkit (CAT) (Release 6)
[TS 102.224]	ETSI 3GPP TS 102.224, Smart cards; Security mechanisms for UICC based Applications - Functional requirements (Release 6)
[TS 102.225]	ETSI 3GPP TS 102.225, Smart cards; Secured packet structure for UICC based applications (Release 6) –
[TS 102.226]	ETSI 3GPP TS 102.226, Smart Cards; Remote APDU structure for UICC based applications (Release 6)
[TS 102.240]	ETSI 3GPP TS 102.240, Smart Cards; UICC Application Programming Interface and Loader Requirements; Service description; (Release 6)
[TS 102.241]	ETSI 3GPP TS 102.241, UICC API, 3GPP Release 6
[TS 102.613]	ETSI 3GPP TS 102.613, UICC - Contactless Front-end (CLF) Interface; Part 1: Physical and data link layer characteristics (Release 7)
[TS131.111]	ETSI 3GPP TS 131.111, Digital cellular telecommunications system (Phase 2+); Universal Mobile Telecommunications System (UMTS); Universal Subscriber Identity Module (USIM) Application Toolkit (USAT) (Release 6)

	Reference D1226479	Release 1.3p <small>(Printed copy not controlled: verify the version before using)</small>
	Classification level Public	Pages 177

Reference	Title
[T131.130]	ETSI TS 131.130, Digital cellular telecommunications system (Phase 2+); Universal Mobile Telecommunications System (UMTS); (U)SIM Application Programming Interface (API); (U)SIM API for Java Card (3GPP TS 31.130 version 6.6.0 Release 6)

	Reference	D1226479	Release	1.3p <small>(Printed copy not controlled: verify the version before using)</small>
	Classification level	Public	Pages	177

9.4 Glossary

Term	Definition
Application	Instance of an Executable Module after it has been installed and made selectable
APDU	Standard communication messaging protocol between a card accepting device and a smart card
Card Administrator	The card administrator is an external entity issuing the card and performing main functions of card administration (as Card life cycle Management). It is usually the Card Issuer or MNO.
Controlling Authority	A Controlling Authority is entity independent from the MNO represented on the (U)SIM card and responsible for securing the keys creation and personalization of the Supplementary Security Domains.
DAP Block	Part of the Load File used for ensuring Load File Data Block verification
DAP Verification	A mechanism used by a Security Domain to verify that a Load File Data Block is authentic
Delegated Management	Pre-authorized Card Content changes performed by an approved Application Provider
Executable Load File	Actual on-card container of one or more application's executable code. It may reside in Immutable Persistent Memory or may be created in Mutable Persistent Memory as the resulting image of a Load File Data Block.
Executable Module	Contains the on-card executable code of a single application present within an Executable Load File
Issuer Security Domain	The primary on-card entity providing support for the control, security, and communication requirements of the card administrator (typically the Card Issuer or MNO)
Load File	A file transferred to a GlobalPlatform card that contains a Load File Data Block and possibly one or more DAP Blocks
Load File Data Block	Part of the Load File that contains one or more application(s) or libraries and support information for the application(s) as required by the specific platform
Load File Data Block Hash	A value providing integrity for the Load File Data Block
Message Authentication Code	A symmetric cryptographic transformation of data that provides data origin authentication and data integrity
Secure Channel	A communication mechanism between an off-card entity and a card that provides a level of assurance, to one or both entities
Secure Channel Protocol	A secure communication protocol and set of security services
Security Domain	On-card entity providing support for the control, security, and communication requirements of an off-card entity (e.g. the Card Issuer, an Application Provider or a Controlling Authority)
Supplementary Security Domain	A Security Domain other than the Issuer Security Domain dedicated to Application provider.
Token	A cryptographic value provided by a Card Issuer as proof that a Delegated Management operation has been authorized
Verification Authority	The Verification Authority (VA), is a trusted third party represented on the (U)SIM card, acting on behalf of the MNO and responsible for the verification of application signatures (mandated DAP) during the loading process.