



TÜBİTAK BİLGEM

National Research Center of Electronics and Cryptography

**Common Criteria Protection Profile for
Application Firmware of
Secure Smartcard Reader for
Electronic Identity Verification System**

Revision No	2.8
Revision Date	01.08.2017
Document Code	SSR_PP_2.8
File Name	Protection Profile for Application Firmware of Secure Smartcard Reader (SSR) for Electronic Identity Verification System
Prepared by	eID Applications Unit

CONTENTS

1	PP Introduction.....	6
1.1	PP Reference	6
1.2	TOE Overview	6
1.2.1	Major Security Features of a TOE.....	6
1.2.2	Types of SSR Devices	7
1.2.3	Non TOE Hardware/ Software/ Firmware.....	9
1.2.4	Actors and External Systems	10
1.2.5	Operational Environments of SSR	10
1.2.7	TOE Life Cycle	15
2	Conformance Claims.....	16
2.1	CC Conformance Claim.....	16
2.2	PP Claim.....	16
2.3	Package Claim.....	16
2.4	Conformance Rationale.....	16
2.5	Conformance Statement	16
3	Security Problem Definition	18
3.1	Factors Effecting the Security Problem Definition	18
3.2	Assets.....	18
3.3	Subjects and External Entities	20
3.4	Relevance of External Entities to the TOE on Different SSR Types	22
3.5	Threats.....	23
3.6	Organizational Security Policies	27
3.7	Assumptions	29
3.8	Relevance of Threats, OSPs and Assumptions to the TOE on Different SSR Types.....	30
4	Security Objectives	33
4.1	Security Objectives for the TOE.....	33
4.2	Security Objectives for the Operational Environment	40
4.3	Application of Security Objectives to the TOE on Different SSR Types.....	45
4.4	Coverage Of Threats, OSPs and Assumptions by the Security Objectives	49
4.5	Security Objectives Rationale	55

Application Firmware of SSR for eID Verification System

5	Extended Components Definition	62
5.1	FPT_IDA Imported TSF Data Authentication	62
5.1.1	FPT_IDA.1 Imported TSF Data Authentication	62
5.2	FPT_SSY State Synchronization	63
5.2.1	FPT_SSY.1 State Synchronization	63
6	Security Requirements	64
6.1	Security Functional Requirements	64
6.1.1	Class FAU: Security Audit.....	64
6.1.2	Class FCS: Cryptographic Support.....	67
6.1.3	Class FIA: Identification and Authentication	72
6.1.4	Class FCO: Communication.....	76
6.1.5	Class FMT: Security Management	76
6.1.6	Class FPT: Protection of the TSF	79
6.1.7	Class FDP: User Data Protection.....	83
6.1.8	Class FTP: Trusted Path/Channels	85
6.2	Application of SFRs to TOE on different SSR Types and Biometric Sensor / EPP Configurations.....	86
6.3	Security Assurance Requirements.....	86
6.4	Security Requirements Rationale.....	86
6.4.1	Security Functional Requirements Rationale	86
6.4.2	Security Functional Requirements Rationale Tables.....	92
6.4.3	Security Assurance Requirements Rationale.....	98
7	Glossary and Acronyms	99
7.1	Glossary	99
7.2	Acronyms.....	100
7.3	References.....	101

LIST OF TABLES

Table 1. Comparison of SSR types 7

Table 2. Primary and Secondary Assets..... 18

Table 3. Legitimate and malicious actors and external systems 20

Table 4. Legitimate Entities vs SSR Types 22

Table 5. Threats 23

Table 6. Organizational security policies 27

Table 7. Assumptions 29

Table 8. Relevance of Threats, OSPs and Assumptions to the three TOE types 30

Table 9. Security Objectives of the TOE 33

Table 10. Security Objectives for the Operational Environment 40

Table 11. Application of Objectives to the TOE on different SSR Types 45

Table 12. Application of Environment Objectives to the different SSR Types and User Environments of different SSR Types..... 47

Table 13. Security Objectives Rationale Table for TOE on Either SSR Type I, II, III without Biometric Sensor and External Pin Pad..... 49

Table 14. Environmental Security Objectives Rationale Table for TOE on Either SSR Type I, II, III without External Biometric Sensor and External Pin Pad 51

Table 15. Additions to Security Objective Rationale due to differences of SSR Type II, III from SSR Type I..... 53

Table 16. Additions to Security Objective Rationale for TOE on SSR with External/Internal Biometric Sensor and/or EPP 54

Table 17. Additions to Security Objective Rationale for TOE on SSR Type III 54

Table 18. Justification According to The Configuration of TOE 55

Table19. SFR Rationale Table for TOE on SSR Type I without Biometric Sensor and External PIN Pad 92

Table20: SFR Rationale for additional objectives of TOE on SSR Type II and SSR Type III 96

Table21: SFR rationale additions for TOE on SSR with External/Internal Biometric Sensor and/or EPP 96

Table22: SFR Rationale for additional objectives of TOE on SSR Type III..... 97

LIST OF FIGURES

Figure 1. Typical Software/Firmware Environment of TOE..... 9

Figure 2. Typical SSR Hardware 9

Figure 3. User Environment of Type I..... 11

Figure 4. User Environment of Type II (without SAS)..... 12

Figure 5. User Environment of Type II (with SAS) 13

Figure 6. User Environment of Type III..... 14

1 PP INTRODUCTION

1.1 PP REFERENCE

Title: Protection Profile for Application Firmware of Secure Smartcard Reader for Electronic Identity Verification System

CC Version: 3.1 (Revision 5)

Assurance Level: EAL4+ with ALC_DVS.2 augmentation

Version Number: v2.8

Keywords: Electronic Identity, Smartcard Reader, Identity Verification, Electronic Identity Card, Secure Smartcard Reader, and Biometric Authentication

1.2 TOE OVERVIEW

The TOE is the Secure Smartcard Reader (SSR) Application Firmware running on SSR Device. The SSR is the identity verification terminal for the eID Verification System (eIDVS) defined by TS13584. As the application firmware of the SSR, the TOE performs identity verification of Service Requester and Service Attendee according to the eIDVS, securely communicating with the other system components and as a result of the identity verification, produces an Identity Verification Assertion (IVA) signed by the Secure Access Module (SAM) inside the SRR. The TOE also covers the root certificates used for the identification & authentication purposes.

1.2.1 MAJOR SECURITY FEATURES OF A TOE

The following security mechanisms are primarily mediated in the TOE:

- Identification and Authentication,
 - Cardholder verification by using PIN and biometrics (fingerprint, finger vein, or palm vein data).
 - Authentication of eID Card by the TOE,
 - Authentication of Role Holder by eID Card and by the TOE,
 - Authentication of SAM by the TOE and by eID Card,
 - Authentication of the TOE by SAM and by Card Holder (Service Requester and Service Attendee) and by external entities (e.g. EPP, EBS, Role Holder, etc.),
- Secure Communication between the TOE and

Application Firmware of SSR for eID Verification System

- SAM
 - eID Card
 - Role Holder
 - other trusted IT Components
- Security Management,
 - Self-Protection,
 - Audit.

Among the certificates used in the eID Verification System, certificates of the root CA, device management CA and eID management CA are included in the TOE.

1.2.2 TYPES OF SSR DEVICES

This Protection Profile supports TOE on three different operational environments. Operation environment is the SSR Platform and SSR User Environment including the other parties that SSR communicates to the SSR Application Firmware.

Properties of the three operational environments are compared in Table 1.

Table 1. Comparison of SSR types

	Type I	Type II	Type III
User Interface of SSR Device	<ul style="list-style-type: none"> · Pinpad, · Display, · One smartcard slot, · Biometric sensor (internal, external or does not exist) · External pinpad (optional) 	<ul style="list-style-type: none"> · Pinpad, · Display, · Two smartcard slots, · Biometric sensor (internal, external or does not exist) · External pinpad (optional) 	<ul style="list-style-type: none"> · Pinpad, · Display, · One or two smartcard slots, · Biometric sensor (internal, external or does not exist) · External pinpad (optional)
Service Provider Client Application (SPCA)	Running on PC	Running on PC	Included in the TOE
SSR Access Server (SAS)	N/A	Optional	N/A
Communication Environment of SSR	· SSR communicates to Service Provider Client Application (SPCA) through USB Interface. SPCA	· SSR communicates to Service Provider Client Application through USB interface or communicates to SAS	· SSR directly communicates to IVPS/ APS/ OCSPS through wireless

Application Firmware of SSR for eID Verification System

	communicates to Identity Verification Policy Server (IVPS) / Application Server (APS)/ Online Certificate Status Protocol Server (OCSPS).	through Ethernet interface. SPCA or SAS communicates to IVPS / APS/ OCSPS.	interface.
Service Attendee Support	N/A	Yes	Optional
Secure Upgrade	Yes	Yes	Yes
Revocation Status Control	Three options: (1) Online OCSP query (2) Offline Revocation List Control (3) No control	Three options: (1) Online OCSP query (2) Offline Revocation List Control (3) No control	Two options: (1) Online OCSP query (2) Offline Revocation List Control
Optional Online/Offline Mode	Works Online	Works Online	Storing Identity Verification Assertions when the connection is failed

Offline mode is a valid option only for SSR Type III Devices. If the SSR type III Device has the offline IVA generation and storage mode, the IVA can be generated and stored within the SSR when the SSR cannot reach to the APS. The confidentiality of the IVAs shall be assured during storage. Integrity concern of the IVAs does not exist since the IVAs are already electronically signed by the SAM.

1.2.3 NON TOE HARDWARE/ SOFTWARE/ FIRMWARE

1.2.3.1 Typical Software/ Firmware Environment of TOE

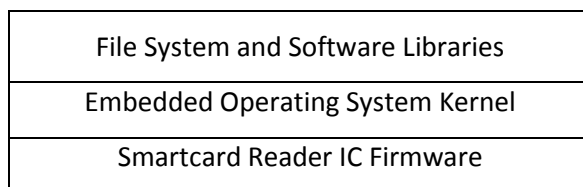

Figure 1. Typical Software/Firmware Environment of TOE

In a typical software environment, the TOE runs at the top of an embedded operating system, its file-system and software libraries. It communicates to a smartcard reader IC firmware within the device.

1.2.3.2 Hardware Environment of TOE (SSR Hardware)

The TOE is stored in a non-volatile memory location in the SSR Hardware as an encrypted binary file. During power-up, the encrypted TOE is decrypted before its execution. A Typical SSR Hardware environment of TOE is shown in Figure 2.

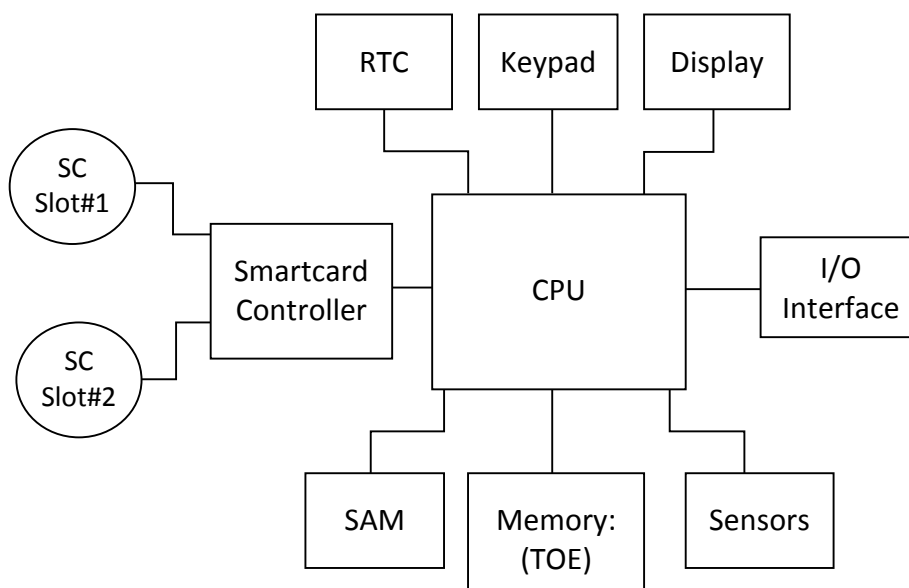

Figure 2. Typical SSR Hardware

Minimum SSR Hardware includes:

- I/O interfaces
- User interfaces (keypad, display, optional biometric sensor),
- CPU,

Application Firmware of SSR for eID Verification System

- Memory components,
- At least one smart card slot,
- Secure Access Module (SAM),
- Real Time Clock (RTC),
- Physical and logical security barriers (shields, tamper switches etc.).

Some hardware components such as biometric sensor, Ethernet port or second smartcard slot are optional depending on the SSR type. There are three possible SSR device types that TOE can be deployed. These types are defined in Section 1.2.4.

1.2.3.3 Optional Hardware

SSR Devices may be developed to operate together with additional hardware components, which are Internal Biometric Sensor, External Biometric Sensor (EBS) and External PIN PAD (EPP). Biometric verification feature is optional for SSR Devices. Both internal and external biometric sensors are accepted for biometric verification. In addition, an External PIN PAD could be supplied with the SSR Hardware as an addition to the on board PIN PAD so as to give ease of use to the user. However, when external biometric sensors or external PIN PADs are applicable, the TOE shall authenticate the external device and protect the confidentiality and integrity of the communication between the TOE and the external device.

1.2.4 ACTORS AND EXTERNAL SYSTEMS

Actors: Service Requester, Service Attendee

External Systems: Service Provider Client Application (SPCA), Identity Verification Policy Server (IVPS), Application Server (APS), SSR Access Server (SAS), Identity Verification Server (IVS), Electronic Identity Card (eID Card), Service Requester (SR), Service Attendee (SA), Online Certificate Status Protocol (OCSP) Server, Identity Faker, Illegitimate eID Card, SSR Access Server, PC, SAM, External Biometric Sensor (if applicable), External Pinpad (if applicable).

1.2.5 OPERATIONAL ENVIRONMENTS OF SSR

User environments and usage scenarios are explained for the three types of TOE Environment.

1.2.5.1 Operational Environment for SSR Type I

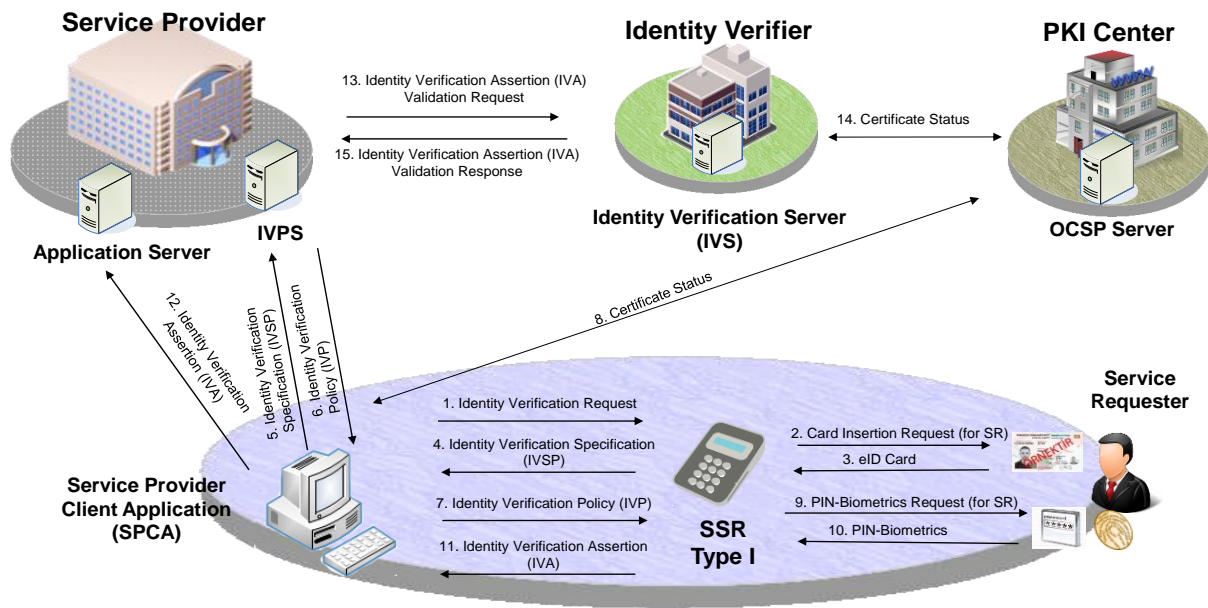

Figure 3. User Environment of Type I

The following scenario explains how Type I devices perform Identity Verification Operation in the environment shown in Figure 3. Operation is initiated by the Service Provider Client Application (SPCA), which is installed on a personal computer (PC).

First, SPCA sends an Identity Verification Request to TOE. Once the TOE receives this request, it asks the SR to insert his/her eID card into the smartcard slot. After the eID card is inserted, the TOE sets up a secure messaging session with the eID card. Having read the cardholder’s personal message from the eID card, the TOE displays it on the screen for the SR’s approval. If the SR approves the displayed message, an Identity Verification Specification is generated by the TOE, and sent to SPCA. Next, SPCA connects to the Identity Verification Policy Server (IVPS) and gets the Identity Verification Policy (IVP) for the SR specified in the IVSP. After that, SPCA sends the IVP to the TOE. Since the policy is signed by the IVPS, the TOE checks the signature to make sure it comes from a legitimate IVPS and hasn't been modified. The IVP defines the Identity Verification Method (IVM) for the SR and the organizational policies defined in TS 13584. If an IVPS doesn’t exist, the SPCA defines the IVM itself. Otherwise, the TOE uses the predefined default IVM that has the highest security level. During identity verification, the Identity Verification Certificate within the eID Card is not only verified offline by the TOE, but also checked online with the help of the Online Certificate Status Protocol (OCSP) Server. If the online certificate check cannot be achieved due to technical problems, there are two options to continue the operation: (i) the TOE checks the eID Card of the Service Requester using the Certificate Revocation List downloaded on the SSR Device. In this case, the information that “OCSP

Application Firmware of SSR for eID Verification System

check could not be achieved" shall be included in the IVA;(ii) the TOE does not check the eID Card of the Service Requester. In this case, the information that "OCSP check and Revocation List control could not be achieved" shall be included in the IVA. In addition to certificate verification and validation, according to the IVM, if requested, PIN verification and biometric verification of the SR is done by the TOE using fingerprint, fingervein or palmvein data. At the end of the authentication, an Identity Verification Assertion (IVA) is generated by the TOE. Since the IVA is signed by the SAM, it assures origin of identity, time and place. The TOE sends the IVA to the SPCA and finally, the SPCA forwards the IVA to the IVS, where it's further validated and kept as the evidence for the operation. Until the IVA is validated by the IVS, the Identification and Authentication of SR is regarded as incomplete.

1.2.5.2 Operational Environment for SSR Type II

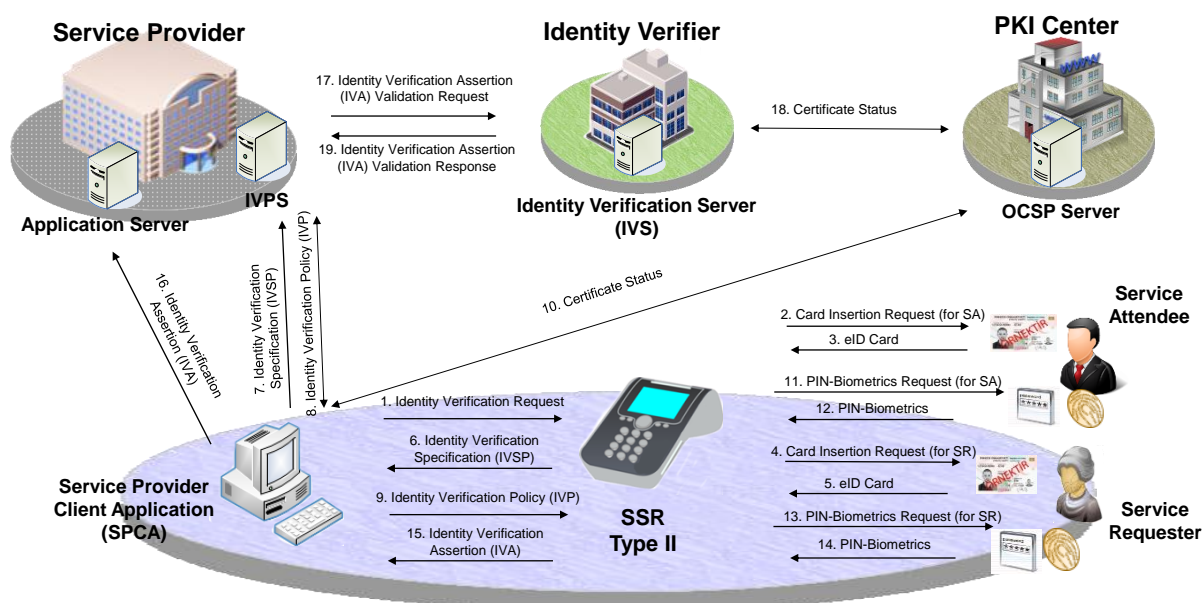

Figure 4. User Environment of Type II (without SAS)

User environments for Type II devices are given in Figure 4 and Figure 5. As seen, two smartcard slots are required for Type II devices. The second smartcard slot is needed for Service Attendee support. The SPCA initiates the operation. If SSR Access Server (SAS) exists as shown in Figure 5, the SPCA communicates to the TOE through the SAS via Ethernet interface, otherwise, it communicates to the TOE via USB interface.

Application Firmware of SSR for eID Verification System

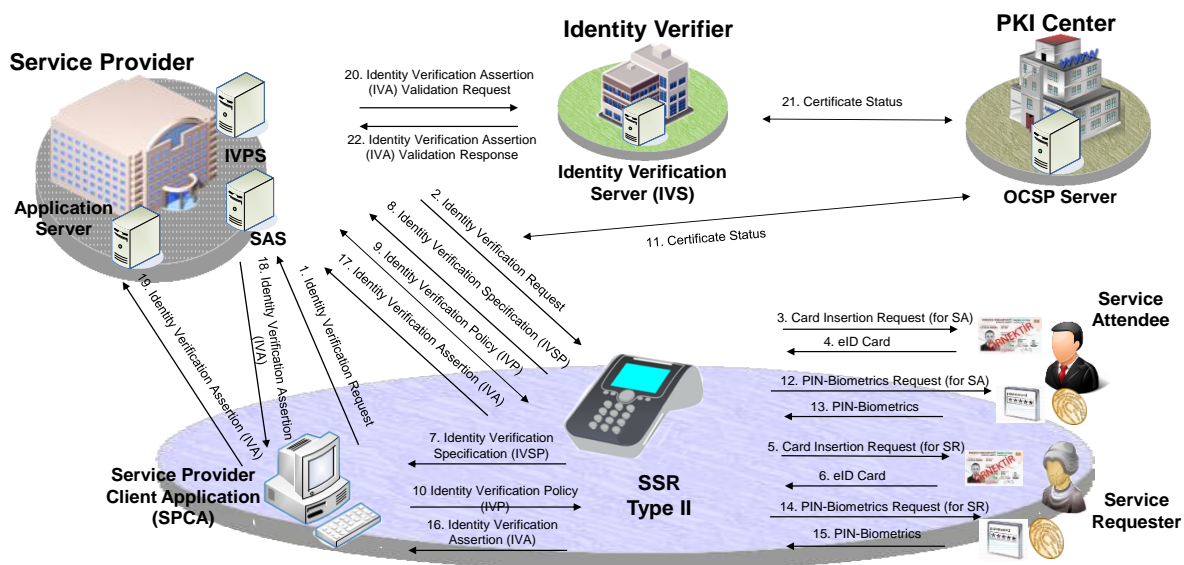

Figure 5. User Environment of Type II (with SAS)

In this scenario, the procedures are similar to the scenario for Type I SRR devices. However, in addition to Identification and Authentication of SR, Type II SRR devices also support Identification and Authentication of Service Attendee (SA) thanks to the second smartcard slot. At the end of the Identification and Authentication of SR and SA, an Identity Verification Assertion (IVA) is generated by the TOE. This time the IVA includes Service Attendee information as well. The TOE sends the IVA to the SPCA. Finally, SPCA forwards the IVA to IVS, which validates it and keeps it as an evidence for the operation. Until the IVA is validated by the IVS, the Identification and Authentication of SR and SA is regarded as incomplete.

1.2.5.3 Operational Environment for SSR Type III

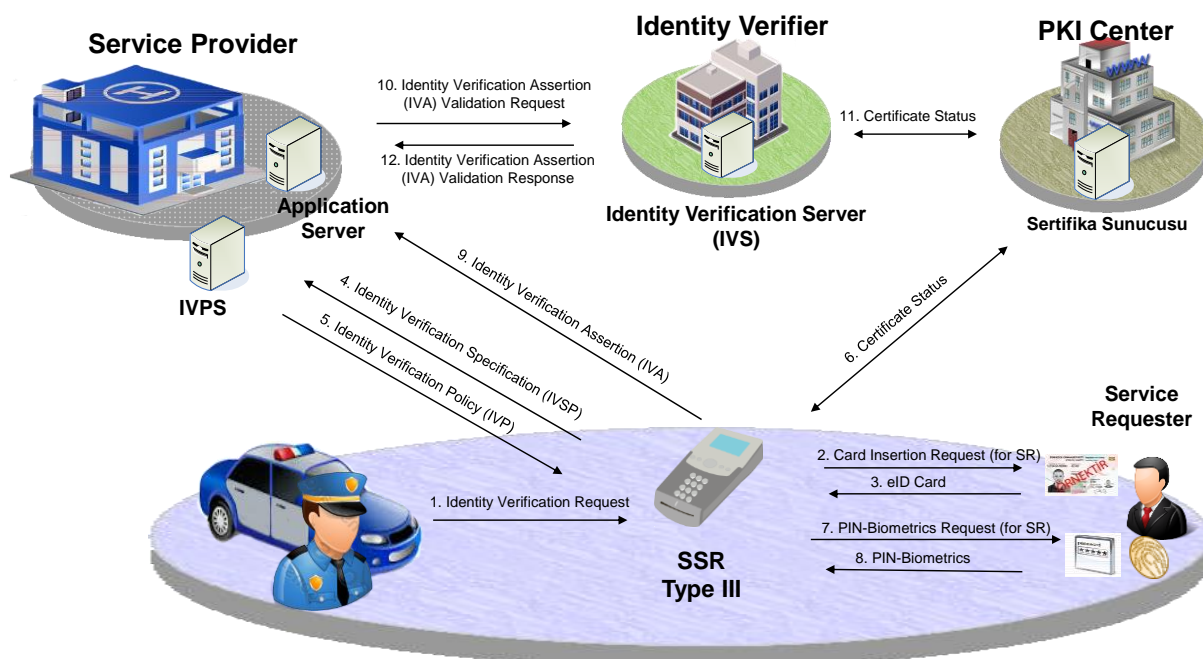

Figure 6. User Environment of Type III

User environment for Type III devices is given in Figure 6. Type III device is intended for mobile use. As seen, the environment doesn't require a PC. The TOE performs the functions of SPCA itself. It directly communicates to OSPCS, Application Server and IVPS. Type III devices may have one or two smartcard slots depending on usage. In the scenario, the procedures are similar to the scenario for Type I and Type II devices. However, the TOE itself initiates the Identification and Authentication Operation. In addition, offline usage scenarios are defined for mobile SSR Device. In case OCSP Server is not reached, TOE checks the eID Card of the Service Requester from the Revocation List downloaded on the SSR Device and puts the information that OCSP could not be achieved into the IVA. This scenario is the same as the Type I and Type II Devices. However, the revocation list shall be downloaded onto the mobile SSR since SSR Device could run totally offline for maximum offline working time duration. In addition, if the connection with the APS is failed, IVAs could be stored in the SSR Device securely until the device becomes online again. The maximum offline working time is defined by the authorized foundations. Stored IVAs should be transmitted to APS securely before this time.

1.2.7 TOE LIFE CYCLE

The TOE shall support:

- Initialization & Configuration
- Operation Phases

After production, the TOE is in Initialization & Configuration Phase. In the Initialization & Configuration Phase, the TOE and all other SSR firmware including operating system and file system are installed to the SSR Device by Initialization agent in a secure environment. After the initialization and the configuration, the TOE switches to the Operation Phase and doesn't go back to the Initialization & Configuration Phase again except tampering of the SSR. Tampering event is the only condition to set the TOE back to the Initialization & Configuration Phase. If a tampering event is detected, cryptographic data (keys, SAM Pin, etc.) within the SSR are deleted and the TOE becomes out of service; the TOE and other software including operating system, file system and other firmware need to be re-installed and it has to be initialized and configured by authorized personnel. In addition, SSR and the TOE have close relations with the SAM in the SSR. Therefore, SAM life cycle and SAM processes related to the TOE and the SSR are given briefly in the following subsections.

1.2.7.1 Obtaining SAM to Produce an SSR

SAM cards and test SAM Cards are supplied by Authorized SAM Provider (ASP). Detailed information about obtaining the SAM cards is provided by ASP.

During development of SSR, the TOE manufacturer configures the prototype SSR device with test-SAM cards and then applies to an accredited CC Laboratory and the CC Scheme for CC certification. In addition, the manufacturer applies to an accredited laboratory and the Turkish Standardization Institution (TSE) for TS 13582 - TS 13585 conformance certification. Unless the SSR is certified according to this PP and TS 13582, TS 13583, TS13584, TS 13585 Turkish Standards, the manufacturer is not given production SAM cards by ASP.

In some cases, an External Biometric Sensor (EBS) and/or an External PIN Pad could be supplied separately with the SSR. In these cases, the TOE authenticates and securely communicates to the EBS and/or the EPP as defined in TS 13584[3]. EBS or EPP Developers acquires test- EBS SAM cards or test-EPP SAM cards from ASP for testing their EBS or EPP.

After the test and certification processes are completed successfully, EBS, EPP and SSR Developers apply for actual SAM cards.

2 CONFORMANCE CLAIMS

2.1 CC CONFORMANCE CLAIM

This PP/ST claims conformance to

- Common Criteria for Information Technology Security Evaluation, Part 1: Introduction and General Model; CCMB-2017-04-001 Version 3.1 Revision 5, April 2017, (CC Part 1)
- Common Criteria for Information Technology Security Evaluation, Part 2: Security Functional Components; CCMB--2017-04-002 Version 3.1 Revision 5, April 2017, (CC Part 2)
- Common Criteria for Information Technology Security Evaluation, Part 3: Security Assurance Requirements; CCMB--2017-04-003 Version 3.1 Revision 5, April 2017, (CC Part 3)

as follows

- Part 2 extended
- Part 3 conformant
- The Common Methodology for Information Technology Security Evaluation, Evaluation Methodology; CCMB--2017-04-004 Version 3.1 Revision 5, September 2017, [CEM] has to be taken into account.

2.2 PP CLAIM

This PP does not claim conformance to any other Protection Profiles.

2.3 PACKAGE CLAIM

This PP is conforming to assurance package EAL4 augmented with ALC_DVS.2 defined in CC part 3 (CC Part 3).

2.4 CONFORMANCE RATIONALE

Since this PP is not claiming conformance to any other protection profile, no rationale is necessary here.

2.5 CONFORMANCE STATEMENT

This PP requires strict conformance of any ST or PP, which claims conformance to this PP. It is required that conformance statement includes the Configuration Type of the TOE.

Application Firmware of SSR for eID Verification System

This protection profile defines three configurations of Type I, Type II and Type III. The ST conforming to this PP will state first its type and will conform to the SPD, OTs (Security Objectives for TOE) and SFRs and SARs defined for its type.

3 SECURITY PROBLEM DEFINITION

This part of the PP defines the security problem that is to be addressed by both the TOE and its environment. It consists of Assets, Subjects and External Entities, Organizational Security Policies, Threats and Assumptions.

3.1 FACTORS EFFECTING THE SECURITY PROBLEM DEFINITION

Operational Environments for three SSR Types and interaction between the SSR device and external system components are defined in Section 1.2.5. Optional external/ internal hardware components of SSR Device are defined in Section 1.2.3.3. These two sections together define the possible alternatives for the TOE operational environments. Operational environment of the TOE and optional offline use cases of the TOE, given in Table 1, are the factors effecting the security problem definition.

Each factor brings about additional security needs. Therefore, in this PP document, Security Problem Definition, Security Objectives and Security Functional Requirements are designed to cover all the possible alternatives. ST writer should choose the appropriate ones in the ST document according to SSR Type, Operational environment, external/ internal optional hardware components and covered offline use cases.

3.2 ASSETS

The Secure Smart Card Reader (SSR) and the TOE is a part of eID Verification System. TOE carries out identification and authentication operations and accesses (reads out and performs management operations of) eID Card on behalf of authorized entities (Role Holder) who has privileges on the eID Card. TOE shall securely forward the user data read out from the eID Card; however, TOE does not store any user data.

The TOE defined in this PP (the Application Firmware of the SSR) does not possess any user data.

Table 2. Primary and Secondary Assets

Primary Assets: User Data		Definition	Protected against loss of
1.	PIN and Biometry data.	PIN and Biometry data of Service Requester and Service Attendee.	Integrity and confidentiality
2.	SAM-PIN	Used to authenticate the TOE to the SAM	Integrity and confidentiality

Application Firmware of SSR for eID Verification System

3.	Identity Verification Assertion (IVA)	Generated as the evidence of the identity verification operation.	Privacy, and authenticity
Secondary Assets: Security Services		Definition	Protected against loss of
4.	Identification and Authentication of Service Requester and Service Attendee	Personal Identity Verification is performed by this service.	Correct operation
5.	Identification and Authentication of third party trusted IT Components	Identity Verification of third party IT Components are performed by this service. These components are Application Server (APS), SSR Access Server (SAS), External Biometric Sensor (EBS), External PIN PAD (EPP) and SAM	Correct operation
6.	Access eID Card on behalf of Role Holder	Secure messaging session between the TOE and the Role Holder is setup. The TOE accesses the eID card on behalf of the Role Holder. Data transfer between the TOE and the Role Holder is managed in a secure manner using the secure messaging session.	Correct operation
Secondary Assets: TSF Data		Definition	Protected against loss of
7.	Device Tracking Number of SSR	A number specific to each TOE that is written during initialization of TOE. Stored in the memory of the SSR.	Integrity

Application Firmware of SSR for eID Verification System

8.	Secure Messaging and Role Card Verifiable Certificates of SAM (in CVC Format)	Secure Messaging Certificate is used for Secure Messaging between the TOE and eID Card; Role Card Verifiable Certificate is used for Role Authentication of the SSR. These certificates are given by Device Management Certificate Authority and imported from SAM to the SSR Device and updated by the TOE before the expiry date.	Correctness
9.	Current Time	The time defined by OCSP server. TOE uses this time for ID verification assertion.	Integrity
10.	Audit Data	Audit Data	Integrity

3.3 SUBJECTS AND EXTERNAL ENTITIES

Table 3 gives the legitimate and the malicious actors and external entities. The legitimate ones are given in the left column and the malicious ones are given in the right column of Table 3.

Table 3. Legitimate and malicious actors and external systems

Legitimate subjects and entities	Malicious subjects and entities
Service Provider Environment	
Service Provider Client Application	See Note 1
Identity Verification Policy Server	Illegitimate Identity Verification Policy Server
Application Server	Illegitimate Application Server
SSR Access Server	Illegitimate SSR Access Server
Identity Verification Server	See Note 2
Identity Verification Environment	
eID Card	Illegitimate eID Card

Application Firmware of SSR for eID Verification System

Service Requester (SR)	Identity Faker (not real Service Requester)
Service Attendee (SA): validates photo of the card holder and has rights to proceed the operation even if the biometric verification fails	SA Masquerader (attacker acting as if Service Attendee)
SAM	Illegitimate SAM
External Biometric Sensor	Illegitimate External Biometric Sensor
External Pin Pad	Illegitimate External Pin Pad
Secure Smartcard Reader (SSR) hardware.	Illegitimate SSR hardware (manipulated and/or probed)
Role Holder	Illegitimate Role Holder (Malicious)
The Proxy Entities	
PC (on which the SPCA runs)	See Note 3.
Other Activities	
Initialization agent	-
Manufacturer service operator	Illegitimate service operator
Attacker	
	Attacker (also covers the Identity Faker, SA Masquerader, Illegitimate Role Holder)

Note 1: It is assumed that no illegitimate Service Provider Client Application (SPCA) exists within the current context.

Note 2: No illegitimate Identity Verification Server (IVS) exists within the current context. The reason the IVS is taken into the scope this PP, is its required ability to distinguish the IVAs created by the TOE with the IVAs created by illegitimate TOEs.

Note 3: It is assumed that (1) the PC is free of any malicious software and (2) the environment between the USB Interface Software and the TOE is secure. So no illegitimate USB Interface Software and illegitimate PC are defined within the system.

Note 4: Within the current system context, the role holder has privileges on the eID Card. The attacker will try to exploit these privileges to gain benefits.

Note 5: Initialization agent is assumed to pose no threat because the environment is secure and personal acts responsively.

Application Firmware of SSR for eID Verification System

Note 6: The attacker is the threat agent who tries to violate the security of the eID Verification System. Note that the attacker here is assumed to possess at most *enhanced-basic attack potential* (which means that the TOE to be tested against AVA_VAN.3).

3.4 RELEVANCE OF EXTERNAL ENTITIES TO THE TOE ON DIFFERENT SSR TYPES

Some of the entities defined in the Subsection 3.3 are valid for all the three types of SSR Device, however, some entities are irrelevant for one or two types of the SSR Device. Table 4 shows the relevance of these entities for three types of SSR Device.

Table 4. Legitimate Entities vs SSR Types

Entity	Applies to
Service Provide Client Application	Applies to Type I and Type II.
Identity Verification Policy Server	Applies to all
Application Server	Applies to all (but only TOE on SSR Type III has direct contact)
SSR Access Server	Applies to Type II
Identity Verification Server	Applies to all
eID Card	Applies to all
Service Requester	Applies to all
Service Attendee	Applies to Type II and Type III
Online Certificate Status Protocol Server	Applies to all
PC	Applies to Type I and Type II
Security Access Module	Applies to all
SSR Hardware	Applies to all
External Biometric Sensor	Applies to configurations with External Biometric Sensor
External Pinpad	Applies to configurations with External Pin Pad

3.5 THREATS

The threats that could be met by the TOE and its environment are given in Table 5.

Table 5. Threats

Threat	Definition
<u>T.Counterfeit eIDC</u>	An attacker (Identity Faker) may present a counterfeit eID Card (form of illegitimate eID Card) to the TOE for faking his or her identity. This action is also regarded as damaging the correct operation of the Identification and Authentication of the Service Requester and the Service Attendee.
<u>T.Revoked eIDC</u>	An attacker (Identity Faker) may present a revoked eID Card (form of illegitimate eID Card) to the TOE for faking his or her identity. This action is also regarded as damaging the correct operation of the Identification and Authentication of the Service Requester and the Service Attendee.
<u>T.Stolen eIDC</u>	An attacker (Identity Faker) may present a stolen (not an illegitimate eID Card) to the TOE for faking his or her identity. This action is also regarded as damaging the correct operation of the Identification and Authentication of the Service Requester and the Service Attendee
T.IVA_Fraud	An attacker may create a fraudulent Identity Verification Assertion IVA (totally fake, build from scratch, or modified from a legitimate IVA).
T.IVA_Eavesdropping (valid for Type II and Type III TOE)	The attacker may obtain Identity Verification Assertion by monitoring the communication line between type III TOE and the Application Server or the communication line between SAS and type II TOE.
<u>T.IVA Confidentiality[valid only for offline mode of TOE on SSR Type III]</u>	An attacker may steal the IVAs stored in the SSR Type III memory area during the offline operation of the SSR Type III.
<u>T.Repudiation</u>	The Service Requester (or the Service Attendee) may repudiate the Identification Verification Assertion.

Application Firmware of SSR for eID Verification System

<p><u>T.Fake TOE to SR</u></p>	<p>An attacker may prepare a fake SSR and introduce it to the Service Requesters (and/or Service Attendee). This way, the attacker may collect the Identity Verification Card-PIN and Biometric Information.</p>
<p><u>T.Fake TOE to External Entities</u></p>	<p>An attacker may introduce himself/herself as legitimate TOE to the external entities: eID Card, External Biometric Sensor, External PIN Pad. Thus obtain the PIN and biometric information of the Service Requester (or the Service Attendee) and gain access to eID Card on behalf of the Role Holder.</p>
<p><u>T.SA Masquerader</u></p>	<p>An attacker may act as if he/she is a legitimate service attendee and perform the photo verification and thus damage the Identification and Authentication Service of the Service Requester.</p>
<p><u>T.SA Abuse of Session</u></p>	<p>An attacker may abuse the service attendee's authentication session. Thus the attacker can validate the photo and/or accept negative result of biometric verification in an unauthorized way. This action therefore is regarded as damaging the correct operation of the Identification and Authentication of the Service Requester and the Service Attendee.</p>
<p><u>T.Fake Policy</u></p>	<p>An attacker may send a fraudulent policy to manage the authentication process in an unauthorized manner. This action is also regarded as damaging the correct operation of the Identification and Authentication of the SA and the SR.</p>
<p><u>T.Fake OCSP Response</u></p>	<p>An attacker may mimic a legitimate Online Certificate Status Protocol Server (OCSPS) or manipulate the TSF Data transmitted by OCSPS. This action is also regarded as damaging the correct operation of the Identification and Authentication of the SA and the SR.</p>
<p><u>T.RH Comm</u></p>	<p>An attacker may access or modify the eID Card contents through eavesdropping and manipulating the communication between the Role Holder and eID Card.</p>

Application Firmware of SSR for eID Verification System

<p><u>T.RH Session Hijack</u></p>	<p>An attacker may access or modify the eID Card contents through hijacking the authentication session between the eID Card and the Role Holder.</p>
<p><u>T.Illegitimate EBS</u></p>	<p>An attacker may change the outcome of biometric verification¹ or steal or modify the transmitted biometric template, thus collect biometric information from the Cardholders or damage the correct operation of the Identification and Authentication of Service Requester or Service Attendee by using an illegitimate biometric sensor.</p>
<p><u>T.EBS Comm</u></p>	<p>An attacker may change the outcome of biometric verification; steal or modify the transmitted biometric template, thus collect biometric information from the Cardholders or damage the correct operation of the Identification and Authentication of Service Requester or Service Attendee through (1) eavesdropping and modifying the communication; (2) hijacking or replaying the authentication session between the TOE and the EBB.</p>
<p><u>T.Illegitimate EPP</u></p>	<p>An attacker may steal or modify the transmitted PIN, thus collect PIN information from the Cardholders or damage the correct operation of the Identification and Authentication or Service Requester of Service Attendee by using an illegitimate external PIN-PAD.</p>
<p><u>T.EPP Comm</u></p>	<p>An attacker may steal or modify the transmitted PIN, thus collect PIN information from the Cardholders or damage the correct operation of the Identification and Authentication of Service Requester or Service Attendee through (1) eavesdropping and modifying the communication; (2) hijacking or replaying the authentication session between SSR and EPP.</p>

¹ If biometric verification is implemented on the sensor then biometric verification result is subject of the attack otherwise biometric template is subject of the attack.

Application Firmware of SSR for eID Verification System

<p><u>T.eIDC Comm</u></p>	<p>An attacker may access or modify the eID Card contents, steal the PIN and biometric information, block the PIN and biometric verification through (1) eavesdropping and modifying the communication; (2) hijacking or replaying the authentication session between the TOE and eID Card.</p>
<p><u>T.Illegitimate SAS</u></p>	<p>An attacker may use illegitimate SSR Access Server (SAS) to undermine security policies. This action is also regarded as damaging the correct operation of the Identification and Authentication of third party IT Components for TOE on SSR Type II.</p>
<p><u>T.Illegitimate APS</u></p>	<p>An attacker may use illegitimate Application Server (APS) to undermine security policies. This action is also regarded as damaging the correct operation of the Identification and Authentication of third party IT Components for TOE on SSR Type III.</p>
<p><u>T.DTN Change</u></p>	<p>An attacker may change the Device Tracking Number of the TOE through physically gaining access to the memories. This also damage the correctness of the IVA generated by the TOE.</p>
<p><u>T.SAM-PIN Theft</u></p>	<p>An attacker may read or change the SAM-PIN of the TOE during normal operation by physically accessing the SAM PIN memory area or while TOE is entering the SAM PIN, i. e. sending the SAM PIN to the SAM.</p>
<p><u>T.Audit Data Compromise</u></p>	<p>An attacker may read, change or delete the audit data.</p>
<p><u>T.TOE Manipulation</u></p>	<p>An attacker may manipulate the operation or probe the internals of the SSR. SAM PIN could be obtained by probing the internals of the SSR, or DTN could be manipulated. In addition, a counterfeit Identity Verification Assertion could be created.</p>
<p><u>T.Fake SAM</u></p>	<p>An attacker may issue a fake SAM to obtain the SAM-PIN.</p>

Application Firmware of SSR for eID Verification System

<u>T.Stolen SAM</u>	An attacker may steal a SAM and use it to build an illegitimate SSR.
<u>T.Revoked SAM</u>	An attacker may use a Revoked SAM to build an illegitimate SSR.

3.6 ORGANIZATIONAL SECURITY POLICIES

The OSPs are given in Table 6.

Table 6. Organizational security policies

Policy	Policy Category and Definition
P.IVM_Management	The TOE shall apply the identity verification methods defined by the IVPS. Otherwise if IVPS is not present, identity verification methods defined by the SPCA shall be applied. In absence of those, the TOE shall apply the default policy which has the highest security level
P.TOE_Upgrade	The TOE will have mechanisms for secure field and remote upgrade.
P.Re-Authentication	Authentication of third party IT components will be renewed after 24 hours.
P.Terminal_Cert_Update	Terminal Certificate will be renewed within a period defined in TS 13584 [3]. Client application (for TOE on SSR type I or II), SSR Access Server (for TOE on Type II with SAS) or Application Server (for TOE on SSR Type III) shall update the Secure Messaging and Role Card Verifiable Certificates of SAM one day before the expiration day.
P.Time_Update	The time shall be updated using the real time that is received only from trusted entities.
P.Offline_Operation	In cases when the SSR Type III (mobile SSR) cannot reach to Application Server, TOE on SSR Type III is allowed to operate offline for at most maximum offline working time, which is defined by the authorized

Application Firmware of SSR for eID Verification System

	<p>foundation. IVAs shall be stored on the SSR Device securely and transmitted to APS before this time.</p>
<p>P.Revocation_Control</p>	<p>In case SSR Device cannot reach to OCSP Server, downloading the Revocation List onto the SSR Device and checking the certificate revocation status of the Service Requester (and the Service Attendee if applicable) from this list is allowed. The revocation list shall be up to date. When the certificate revocation check is carried out without OCSP Server, the information regarding that OCSP check could not be realized shall be put in the IVA. If the OCSP Server is not reached and there is no downloaded revocation list, then the information that OCSP check and revocation list control could not be realized shall be put in the IVA. In this case, only the certificate status control is performed offline, other identity verification steps shall be performed online. Unless IVA is validated at IVS and revocation check is completed, Identity Verification is not regarded as completed.</p>
<p>P.DPM</p>	<p>The TOE shall support Initialization & Configuration and Operation lifecycle phases. The phase change shall be from Initialization & Configuration Phase to Operation Phase except tamper event detection case. If a tamper event is detected, TOE shall be out of service and require re-initialization. This shall be the only condition to go back to Initialization & Configuration Phase.</p> <p>DTN and SAM PIN shall be written to the SSR Device during Initialization & Configuration Phase.</p>
<p>P.Tamper_Response</p>	<p>The SSR platform will be able to detect any tampering attempts and will notify the TOE. The TOE will respond to this notification by securely deleting the SAM-PIN and getting into Initialization & Configuration phase.</p>

3.7 ASSUMPTIONS

The assumptions for the operational environment are given in Table 7.

Table 7. Assumptions

A.SPCA	<p>It is assumed that Service Provider Client Application is a trusted third party and its communication with SSR occurs in a secure environment via USB interface. However, for SSR Type II with SAS, there is no direct connection between the SSR and the SPCA, SPCA communicates to the SAS through Ethernet interface.</p> <p>When the Service Provider Client Application determines the identity verification method, it is assumed that the Service Provider Client Application selects the appropriate method.</p> <p>In addition, integrity and the confidentiality of the private data transferred from SSR Device to the Client Application is preserved by the foundation sustaining the Client Application</p>
A.IVPS	<p>It is assumed that the IVPS prepares and sends the policy correctly.</p>
A.EBS-EPP	<p>It is assumed that legitimate External Biometric Sensor (EBS) and legitimate External Pin Pad (EPP) work correctly.</p>
A.PC	<p>It is assumed that the PC executing the Client Application is malicious code free and located in secure environment. In addition, the confidentiality of the private data that might be written into the IVA by the Application Owner as Application Specific Data is preserved by the Application Owner.</p>
A.APS-IVPS	<p>It is assumed that the Application Server and the Identity Verification Policy Server are malicious code free and located in secure environment.</p>
A.Management_Environment	<p>It is assumed that the environments, where initialization and configuration are performed, are secure. And the personal that hold initialization and configuration roles act responsively.</p>
A.SAM_PIN_Environment	<p>It is assumed that the PIN value of the SAM in the SSR is defined in the SSR in secure environment.</p>

Application Firmware of SSR for eID Verification System

A.SSR_Platform	<p>The SSR platform supports the security functionality of the TOE and does not undermine the security properties of it. The SSR platform does not provide any opportunities to the attacker to manipulate or bypass the security functionality of the TOE.</p> <p>The TSF architecture is resistant against attacks that can be performed by attackers possessing Enhanced-Basic attack potential (AVA_VAN.3), it is assumed that SSR Platform does not offer any attack interface to the attacker with enhanced basic attack potential to break the TSF architecture.</p> <p>SSR Platform will store the TOE encrypted during nonoperation times. SSR Platform will decrypt and authenticate the TOE during starting up the TOE.</p>
----------------	--

Application Note: The SSR Platform consists of the physical enclosure, physical hardware, security elements, operating system and other dedicated software. A.SSR_Platform enables that Security Objectives of the TOE and the SSR Platform together are resistant to the attackers possessing Enhanced Basic Attack Potential.

3.8 RELEVANCE OF THREATS, OSPS AND ASSUMPTIONS TO THE TOE ON DIFFERENT SSR TYPES

Threats, OCPs and assumptions defined in the Security Problem Definition are matched with the three types of the SSR Device in Table 8.

Table 8. Relevance of Threats, OSPs and Assumptions to the three TOE types

Security Problem Definition	Applies to
<u>T.Counterfeit_eIDC</u>	Applies to all
T.Revoked_eIDC	Applies to all
T.Stolen_eIDC	Applies to all
T.IVA_Fraud	Applies to all
<u>T.IVA_Eavesdropping</u>	Applies to TOE on SSR Type III

Application Firmware of SSR for eID Verification System

<u>T.IVA_Confidentiality</u>	Applies to TOE on SSR Type III with offline mode feature
T.Repudiation	Applies to all
T.Fake_TOE_to_SR	Applies to all
T.Fake_TOE_to_External_Entities	Applies to all
T.SA_Masquerader	Applies to TOE on SSR Type II and Type III
T.SA_Abuse_of_Session	Applies to TOE on SSR Type II and Type III
T.Fake_Policy	Applies to all
T.Fake_OCSP_Response	Applies to all
T.RH_Comm	Applies to all
T.RH_Session_Hijack	Applies to all
T.Illegitimate_EBS	Applies to TOE on SSR with External Biometric Sensor
T.EBS_Comm	Applies to TOE on SSR with External Biometric Sensor
T.Illegitimate_EPP	Applies to TOE on SSR with External Pin Pad
T.EPP_Comm	Applies to TOE on SSR with External Pin Pad
T.eIDC_Comm	Applies to all
T.Illegitimate_SAS	Applies to TOE on SSR Type II
T.Illegitimate_APS	Applies to TOE on SSR Type III
T.DTN_Change	Applies to all
T.SAM-PIN_Theft	Applies to all
T.Audit_Data_Compromise	Applies to all
T.TOE_Manipulation	Applies to all
T.Fake_SAM	Applies to all
T.Stolen_SAM	Applies to all
T.Revoked_SAM	Applies to all
P.IVM_Management	Applies to all
P.TOE_Update	Applies to all
P.Re-Authentication	Applies to all
P.Terminal_Cert_Update	Applies to all
P.Time_Update	Applies to all
P.Offline_Operation	Applies to TOE on SSR Type III
P.Revocation_Control	Applies to TOE on SSR Type I, Type II and Type III but differently.

Application Firmware of SSR for eID Verification System

P.DPM	Applies to all
P.Tamper_Response	Applies to all
A.SPCA	Applies to all
A.IVPS	Applies to all
A.EBS-EPP	Applies to TOE on SSR with EBS and/or EPP
A.PC	Applies to all
A.APS-IVPS	Applies to all
A.Management_Environment	Applies to all
A.SAM_PIN_Environment	Applies to all
A.SSR_Platform	Applies to all

4 SECURITY OBJECTIVES

In this section part-wise solutions are given against the security problem defined in Part 3.

4.1 SECURITY OBJECTIVES FOR THE TOE

Security Objectives for the TOE are given in Table 9.

Table 9. Security Objectives of the TOE

Objective	Definition
OT.IVM_Management	The TOE shall apply the identity verification methods defined by the IVPS. Otherwise if IVPS is not present, identity verification methods defined by the SPCA shall be applied. In absence of those, the TOE shall apply the default policy which has the highest security level.
OT.Security_Failure	When a tampering event is detected or SAM - PIN authentication failure occurs the TOE shall delete all user and/or security related data and enter out of service mode becoming unusable until reinstallation and re-initialization of the TOE ² .
OT.eIDC_Authentication	The TOE shall support the Card Authentication mechanism defined in TS 13584 [3]. When OCSP Server is not reached, certificate revocation status control of the Service Requester and the Service Attendee could be done using the Revocation List downloaded to SSR Device. The

² Note: The SSR Platform will notify the TOE and the TOE will respond this notification by deleting the SAM-PIN and other security related data, going to initialization and configuration phase.

Application Firmware of SSR for eID Verification System

	<p>revocation list shall be up to date.</p> <p>If the certificate status control of Service Requester or the Service Attendee is carried out without OCSP Server, the information that OCSP check could not be realized shall be put in the IVA. If the OCSP Server is not reached and the Revocation List does not exist within the SRR, then the information that OCSP check and Revocation List check could not be realized shall be put in the IVA.</p>
OT.PIN_Verification	<p>The TOE shall support PIN Verification mechanism defined in TS 13584 [3] for Identification and Authentication of Service Requester and Service Attendee.</p>
OT.Photo_Verification	<p>The TOE shall support Photo Verification defined in TS 13584 [3] for Identification and Authentication of Service Requester.</p>
OT.Biometric_Verification	<p>The TOE shall support Biometric Verification defined in TS 13584 [3] for Identification and Authentication of Service Requester and Service Attendee if applicable.</p>
OT.IVA_Signing	<p>The created Identity Verification Assertion shall be electronically signed by the TOE (using SAM).</p> <p>Otherwise the secure channel is founded in between SPCA and IVS.</p>

Application Firmware of SSR for eID Verification System

<p>OT.IVA_Privacy (valid for Type III)</p>	<p>If the created IVA in the TOE on SSR Type III cannot be transmitted due to connection problems, this IVA shall be stored in the SSR Device in encrypted form. The keys for encryption/decryption are generated by the SAM and transferred to the TOE via secure messaging. The stored IVAs shall be transmitted to the APS (after being decrypted) as soon as possible and not later than the maximum offline working time.</p>
<p>OT.PM_Verification</p>	<p>The eID Card lets the TOE to access Personal Message of the service requester after the secure messaging session defined in TS 13584 [3] is established between the TOE and the eID Card. The TOE shall display the Personal Message to the Service Requester, so that, the Service Requester verifies the authenticity of the TOE and the SSR, since only legitimate TOE can access to the Personal Message.</p>
<p>OT.SA_Identity_Verification</p>	<p>The TOE shall support Identification and Authentication of Service Attendee as defined in TS 13585 [4].</p>
<p>OT.Session_Ending</p>	<p>The TOE shall end the authentication session of the Service Attendee whenever the session expires and/or the eID Card of the Service Attendee is taken out. In addition TOE shall re-authenticate each authenticated third party IT product after 24 hours.</p> <p>(SAS for TOE on SSR Type II (if applicable), APS for TOE on SSR Type III, EPP if applicable, EBS if</p>

Application Firmware of SSR for eID Verification System

	applicable)
OT.Identity_Verification_Policy_Authentication	The TOE shall verify that the source of received Identity Verification Policy is a legitimate IVPS.
OT.OCSP_Query_Verify	The TOE shall verify that the source of received information is a legitimate OCSPS.
OT.APS_DA	Mutual authentication between the TOE on SSR Type III and the APS shall be setup before TOE's doing any action.
OT.SAS_DA	Mutual authentication between the TOE on SSR Type II and the SAS (if applicable) shall be setup before TOE's doing any action.
OT.APS_SC	The TOE on SSR Device Type III shall communicate to APS securely via SSL-TLS as defined in TS 13584 [3].
OT.SAS_SC	The TOE on SSR Device Type II shall communicate to SAS (if applicable) securely via SSL-TLS as defined in TS 13584 [3].
OT.RH_DA [Role Holder Device Authentication]	Mutual authentication between the TOE and Role Holder shall be setup as defined in TS 13584 [3] before TOE's doing any action.
OT.RH_SC Secure Communication with Role Holder	The communication between the TOE and the Role Holder shall be secured by AES-256 CBC and AES-256 CMAC algorithms, mutual authentication

Application Firmware of SSR for eID Verification System

	mechanisms and key exchange method defined in TS 13584 [3].
OT.RH_Session_Ending	The TOE shall end the role holder authentication session of eID Card when the secure communication between the TOE and Role Holder ends.
OT.EBS_DA	The TOE shall support mutual authentication with the External Biometric Sensor as defined in TS 13584 [3].
OT.EBS_SC	The TOE shall ensure the confidentiality, integrity and authenticity of the communication going between the TOE and the External Biometric Sensor as defined in TS 13584 [3].
OT.EPP_DA [External PIN-PAD Device Authentication]	The TOE shall support mutual authentication with the External PIN-PAD defined in SSR Standard TS 13584 [3].
OT.EPP_SC	The TOE shall ensure the confidentiality, integrity and authenticity of the communication going between the TOE and External PIN-PAD as defined in TS 13584 [3].
OT.SM_eID Card [Secure Messaging between TOE and eID Card]	The TOE shall ensure the confidentiality, integrity and authenticity of the communication going between the TOE and the eID Card.

Application Firmware of SSR for eID Verification System

<p>OT.TOE_Upgrade</p>	<p>The TOE shall have TOE update security management function. The TOE shall accept only the Upgrade Package associated with the corresponding SSR SAM. The upgrade operation shall only be enabled by the following roles:</p> <p>(i) Manufacturer Service Operator for manual upgrade operation,</p> <p>(ii) The following third party IT components for online upgrade operation:</p> <ul style="list-style-type: none"> • SPCA for TOE on SSR Type I, • SPCA or SAS for TOE on SSR Type II, • APS for SSR Type III. <p>TOE shall <u>verify that the source of received upgrade package</u> is a legitimate software publisher and TOE shall have a mechanism to <u>decrypt the received TOE upgrade package</u> as defined in TS 13584 [3].</p>
<p>OT.DPM</p> <p>[Device Phase Management]</p>	<p>The TOE shall support Initialization & Configuration and Operation lifecycle phases. The phase change shall be from Initialization & Configuration to Operation. The TOE shall not be switched to the Initialization & Configuration Phase from the Operation Phase unless a tamper event is detected and the TOE becomes out of service.</p>
<p>OT.SAM-PIN_Mgmt</p>	<p>The TOE shall have a management function to write the SAM-PIN to the SSR Device. The SAM PIN shall be written only by the initialization agent during Initialization & Configuration phase.</p>

Application Firmware of SSR for eID Verification System

OT.DTN_Mgmt	The TOE shall have a management function to write the Device Tracking Number to the TOE. The DTN shall be written only by the initialization agent during Initialization & Configuration phase.
OT.Time_Mgmt	The TOE shall have a management function to set the real time that is received only from the OCSP Server.
OT.SM_TOE_and_SAM [Secure Messaging between TOE and SAM]	The TOE shall protect the confidentiality, integrity and the authenticity of the communication between the TOE and the SAM.
OT.SAM-PIN_Sec	The TOE shall protect the confidentiality and integrity of the SAM-PIN during storage and operation regardless of device power state with the help of the SSR platform .
OT.DTN_Integrity	The TOE shall protect the integrity of the Device Tracking Number.
OT.Audit_Data_Protection	The TOE shall control access to the audit data and shall not allow attackers to read, change or delete.
OT.RIP [Residual Information Protection]	PIN, Biometry data, other user data and TSF data shall be copied to only volatile memory and be deleted in a secure way right after the end of the usage.
OT.Auth_SAM_by_TOE [Authentication of SAM by TOE]	The TOE shall authenticate the SAM before doing any operation.
OT.Cert_Update	At each Identity Verification Operation, the TOE shall control the validity of the Secure Messaging

Application Firmware of SSR for eID Verification System

	<p>and Role Card Verifiable Certificates of the SAM.</p> <p>If the expiration date of these certificate(s) are closer than one day, TOE shall request updated certificates from the SPCA (for TOE on SSR type I or II without SAS), the SSR Access Server (for TOE on Type II with SAS) or the Application Server (for TOE on SSR Type III) and update the certificates.</p>
--	--

4.2 SECURITY OBJECTIVES FOR THE OPERATIONAL ENVIRONMENT

Security objectives for the SSR Hardware and the User Environment of the SSR.

Table 10. Security Objectives for the Operational Environment

Objective	Definition
OE.SPCA	<p>Service Provider Client Application shall be developed and used by trusted parties thus accepted as a trusted third party IT product. In addition, the communication between SPCA and the SSR shall occur in secure environment.</p> <p>For the cases when the SPCA determines the identity verification method, the SPCA shall select the appropriate method.</p> <p>SPCA shall encrypt the Identity Verification Assertion before sending it to the Application Server (APS).</p>
OE.IVPS	<p>The IVPS shall:</p> <ul style="list-style-type: none"> • prepare and send the correct policy, • protect the integrity and the authenticity of the policy (it shall sign the policy using its signing certificate), • protect the confidentiality of the private key of its signing certificate.
OE.eID Card	<p>The eID Card shall have the following properties:</p> <ul style="list-style-type: none"> • support PIN verification, • prevent usage of IVC Certificate Private key prior to PIN verification, • store the cardholder’s digital photo,

Application Firmware of SSR for eID Verification System

	<ul style="list-style-type: none"> • store the cardholder’s biometric data (fingerprint, fingervein and palmvein), • support terminal authentication as defined in TS 13584 [3], • store the cardholder’s personal message (shall not let any subject access to the personal message prior to terminal authentication), • support role holder authentication as defined in TS 13584 [3], • support secure messaging as defined in TS 13584 [3], • protect the integrity and confidentiality of the user data and TSF data.
OE.SAM	<p>The SAM shall</p> <ul style="list-style-type: none"> • store security credentials for eID Card Authentication, • support signing the IVA, • store security credentials for External Device Authentication to authenticate External Biometric Sensor and External Pin Pad, • support Secure Messaging key generation mechanisms for the communication between the TOE and the following entities: (1) eID Card, (2) Role Holder, (3) External Biometric Sensor, (4) External Pin Pad as defined in TS 13584 [3], • store the private key (Key Encryption Key) to decrypt the TOE Upgrade package as defined in TS 13584 [3], • support SAM-PIN verification mechanism to authenticate the TOE, • require SAM-PIN verification to allow the TOE to use its services, • support Secure Messaging with the TOE as defined in TS 13584 [3], • support authentication of itself to the TOE, • offer Random Number Generation, • have minimum EAL4+ (AVA_VAN.5) Common Criteria Certificate.

Application Firmware of SSR for eID Verification System

OE.Service_Requester	<p>The Service Requester shall:</p> <ul style="list-style-type: none"> • Protect his/her PIN, • Not enter his/her PIN, or give his/her biometric data prior to personal message verification, • Immediately, inform his/her stolen or lost eID Card.
OE.Service_Attendee	<p>The Service Attendee shall:</p> <ul style="list-style-type: none"> • protect his or her PIN, • not enter his/her PIN, or give his/her biometric data prior to personal message verification, • immediately inform the stolen or lost eID Card, • act responsively during photo verification, • not leave the TOE unattended while his/her identity is verified (shall remove his/her eID Card whenever he/she leaves the environment).
OE.OCSPS	<p>The OCSPS shall:</p> <ul style="list-style-type: none"> • operate correctly, • sign the OCSP answer, • protect the confidentiality of the signing key.
OE.IVS	<p>The IVS shall have the following properties:</p> <ul style="list-style-type: none"> • Supports the verification of the authenticity of the IVA with the Authentication Reference Data (Public Key of IVA Signing Certificate's integrity is protected)
OE.SSR_Platform	<p>The SSR platform will support the security functionality of the TOE and does not undermine the security properties of it. The SSR platform does not provide any opportunities to the attacker, who is possessing enhanced basic attack potential, to manipulate or bypass the security functionality of the TOE.</p> <p>The TSF architecture will be resistant against attacks that can be performed by attackers possessing Enhanced-Basic attack potential (AVA_VAN.3), SSR Platform will not offer any attack interface to the attacker with enhanced basic attack potential to break the TSF</p>

Application Firmware of SSR for eID Verification System

	<p>architecture.</p> <p>SSR Platform will store the TOE encrypted during nonoperation times. SSR Platform will decrypt and authenticate the TOE during starting up the TOE.</p> <p>SSR Platform will have tamper detection mechanism and notify the TOE upon detection of a tamper event. SSR Platform will enable the TOE to securely delete the SAM-PIN and cryptographic keys when deleted SAM-PIN and cryptographic keys will be unrecoverable.</p> <p>SSR Platform will provide correct operation of the TOE.</p> <p>SSR platform will include a Real Time Clock (RTC) Unit with at most 20 seconds fault within 24 hours.</p> <ul style="list-style-type: none"> •
OE.EBS	<p>The EBS shall:</p> <ul style="list-style-type: none"> • will perform biometric verification correctly • support Secure Communication between the EBS and the TOE as defined in TS 13584 [3], • support Terminal Authentication as defined in TS 13584 [3], • protect security credentials within the EBS. • display the personal message of the Service Requester prior to requesting biometric input
OE.EPP	<p>The EPP shall:</p> <ul style="list-style-type: none"> • support Secure Communication between the EPP and the TOE as defined in TS 13584 [3], • support Terminal Authentication as defined in TS 13584 [3], • protect security credentials within the EPP, • display the personal message of the Service Requester prior to PIN • protect the confidentiality of the PIN
OE.Role_Holder	<p>The role holder shall:</p> <ul style="list-style-type: none"> • act responsively • have the appropriate role certificate and its Private Key for Role Holder Authentication

Application Firmware of SSR for eID Verification System

	<ul style="list-style-type: none"> • protect the private key used within Role Holder Authentication • support Secure Communication between the Role Holder and the TOE as defined in TS 13584 [3].
OE.PC	The PC that executes the SPCA shall be malicious code free and be located in secure environment.
OE.Security_Management	The security management environment shall be secure and unauthorized personnel shall not access to the TOE. The security management roles shall act responsively,
OE.SAS	The SAS will support Secure Communication with the TOE on SSR Type II. SAS shall encrypt the Identity Verification Assertion before sending it to the SPCA.
OE.Terminal_Cert_Directory	SPCA (for TOE on SSR type I or II without SAS), SSR Access Server (for TOE on Type II with SAS) or Application Server (for TOE on SSR Type III) shall get the updated Secure Messaging and Role Card Verifiable Certificates of the SAM in periods defined in TS 13585 [4] and forward them to the TOE.
OE.PKI	The issuer of the eID Card shall establish a public key infrastructure for the authentication mechanisms of eID Card Authentication, External Biometric Sensor Authentication, External Pin Pad Authentication, Role Holder Device Authentication, OCSP Response Verification, Identity Verification Policy Verification, and the TOE Upgrade Package Verification.
OE.CM [Credential Management]	All credentials, certificates, authentication reference data, shall be securely created and distributed to the relevant entities. If Revocation List is used for certificate verification, this Revocation List shall be up to date.
OE.APS	The Application server (APS) shall support Secure Communication with the TOE on SSR Type III and with client application for SSR Type I and SSR Type II without SAS. For the cases when the APS determines the identity verification method, the APS shall select the appropriate method.

Application Firmware of SSR for eID Verification System

	APS shall encrypt the Identity Verification Assertion before sending it to the IVS (if IVA received is decrypted in the APS).
OE.SSR_Initialization_Environment	The initialization environment of the SSR Device where SAM PIN is defined to the SSR shall be physically secure.

4.3 APPLICATION OF SECURITY OBJECTIVES TO THE TOE ON DIFFERENT SSR TYPES

Application of Objectives to the TOE on different SSR Types are given in Table 11.

Table 11. Application of Objectives to the TOE on different SSR Types

Objective	Applies to
OT.IVM_Management	Applies to all
OT.Security_Failure	Applies to all
OT.eIDC_Authentication	Applies to all
OT.PIN_Verification	Applies to all
OT.Photo_Verification	Applies to the Type II and Type III configurations
OT.Biometric_Verification	Applies to configurations with external/internal Biometric Sensor
OT.IVA_Signing	Applies to all
OT.IVA_Privacy	Applies to TOE on SSR Type II and III
OT.PM_Verification	Applies to all
OT.SA_Identity_Verification	Applies to the Type II and Type III configurations
OT.Session_Ending	Applies to the Type II and Type III configurations
OT.Identity_Verification Policy_Authentication	Applies to all

Application Firmware of SSR for eID Verification System

OT.OCSP_Query_Verify	Applies to all
OT.APS_DA	Applies to TOE on SSR Type III.
OT.SAS_DA	Applies to TOE on SSR Type II with SAS.
OT.APS_SC	Applies to TOE on SSR Type III.
OT.SAS_SC	Applies to TOE on SSR Type II with SAS.
OT.RH_DA [Role Holder Device Authentication]	Applies to all
OT.RH_SC [Secure Communication with Role Holder]	Applies to all
OT.RH_Session_Ending	Applies to all
OT.EBS_DA	Applies to the configuration with EBS
OT.EBS_SC	Applies to the configuration with EBS
OT.EPP_DA [External PIN-PAD Device Authentication]	Applies to the configuration with EPP
OT.EPP_SC	Applies to the configuration with EPP
OT.SM_eID Card	Applies to all
OT.TOE_Upgrade	Applies to all
OT.DPM	Applies to all
OT.SAM-PIN_Mgmt	Applies to all
OT.DTN_Mgmt	Applies to all
OT.Time_Mgmt	Applies to all
OT.SM_TOE_and_SAM [Security between TOE and SAM]	Applies to all

Application Firmware of SSR for eID Verification System

OT.SAM-PIN_Sec	Applies to all
OT.DTN_Integrity	Applies to all
OT.Audit_Data_Protection	Applies to all
OT.RIP [Residual Information Protection]	Applies to all
	Applies to all
OT.Auth_SAM_by_TOE [Authentication of SAM by TOE]	Applies to all

Application of Environment Objectives to the different SSR Types and User Environments of different SSR Types are given in Table 12.

Table 12. Application of Environment Objectives to the different SSR Types and User Environments of different SSR Types

Environment Objective	Applies to
OE.SPCA	Applies to Type I and Type II
OE.IVPS	Applies to all
OE.eID Card	Applies to all
OE.SAM	Applies to all
OE.Service_Requester	Applies to all
OE.Service_Attendee	Applies to the Type II and Type III
OE.OCSPS	Applies to all
OE.IVS	Applies to all
OE.SSR_Platform	Applies to all
OE.EBS	Applies to the configuration with EBS
OE.EPP	Applies to the configuration with EPP
OE.Role_Holder	Applies to all
OE.PC	Applies to all

Application Firmware of SSR for eID Verification System

OE.Security_Management	Applies to all
OE.SAS	Applies to TOE on SSR Type II with SAS
OE.Terminal_Cert_Directory	Applies to all
OE.PKI	Applies to all
OE.CM [Credential Management]	Applies to all
OE.APS	Applies to all
OE.SSR_Initialization_Environment	Applies to all

Application Firmware of SSR for eID Verification System

4.4 COVERAGE OF THREATS, OSPS AND ASSUMPTIONS BY THE SECURITY OBJECTIVES

Table 13, Table 14, Table 15 and

Application Firmware of SSR for eID Verification System

Table 16 give the coverage of threats, OSPs and assumptions by the security objectives. Table 13 gives the coverage of threats and OSPs by the common TOE security objectives of the TOE on all three types of SSR devices and EPP, EBS configurations and optional offline mode features. Table 14 gives the coverage of threats, OSPs and assumptions by the common environmental security objectives of the TOE on all three types of SSR devices and EPP, EBS configurations and optional offline mode features. Due to different SSR types and presence of EPP, biometric sensor and optional offline mode features, additions to the rationale given in Table 15 and

Application Firmware of SSR for eID Verification System

Table 16.

Table 13. Security Objectives Rationale Table for TOE on Either SSR Type I, II, III without Biometric Sensor and External Pin Pad

	OT.IVM_Management	OT.Security_Failure	OT.eIDC_Authentication	OT.PIN_Verification	OT_IVA_Signing	OT.PM_Verification	OT.Session_Ending	OT.Identity_Verification_Policy_Autjentication	OT.OCSP_Query_Verify	OT.RH_DA	OT.RH_SC	OT.RH_Session_Ending	OT.SM_eID Card	OT.TOE_Upgrade	OT.DPM	OT.SAM-PIN_Mgmt	OT.DTN_Mgmt	OT.Time_Mgmt	OT.SM_TOE_and_SAM	OT.SAM-PIN_Sec	OT.DTN_Integrity	OT_Audit_Data_Protecti	OT.RIP	OT.Auth_SAM_by_TOE	OT.Cert_Update
T.Counterfeit_eIDC	✓		✓										✓												
T.Revoked_eIDC	✓																								
T.Stolen_eIDC				✓																					
T.IVA_Fraud					✓																				
T.Repudiation				✓																					
T.Fake_TOE_to_SR						✓																			
T.Fake_TOE_to_External_Entities										✓			✓												
T.Fake_Policy								✓																	
T.Fake_OCSP_Response								✓																	
T.RH_Comm											✓														
T.RH_Session_Hijack										✓		✓													
T.eIDC_Comm													✓												
T.DTN_Change																	✓								
T.SAM-PIN_Theft		✓																	✓	✓					
T.Audit Data Compromise		✓																				✓			

Application Firmware of SSR for eID Verification System

	OT.IVM_Management	OT.Security_Failure	OT.eIDC_Authentication	OT.PIN_Verification	OT_IVA_Signing	OT.PM_Verification	OT.Session_Ending	OT.Identity_Verification_Policy_Autjentication	OT.OCSP_Query_Verify	OT.RH_DA	OT.RH_SC	OT.RH_Session_Ending	OT.SM_eID Card	OT.TOE_Upgrade	OT.DPM	OT.SAM-PIN_Mgmt	OT.DTN_Mgmt	OT.Time_Mgmt	OT.SM_TOE_and_SAM	OT.SAM-PIN_Sec	OT.DTN_Integrity	OT_Audit_Data_Protecti	OT.RIP	OT.Auth_SAM_by_TOE	OT.Cert_Update
T.TOE_Manipulation																			✓	✓	✓	✓	✓		
T.Fake_SAM																								✓	
T.Stolen_SAM																✓			✓	✓				✓	
T.Revoked_SAM																								✓	
P.IVM_Management	✓																								
P.TOE_Upgrade														✓											
P.Terminal_Cert_Update																									✓
P.Re-Authentication							✓																		
P.Time_Update																		✓							
P.Revocation_Control			✓																						
P.DPM															✓	✓	✓								
P.Tamper_Response			✓																						

Application Firmware of SSR for eID Verification System

Table 14. Environmental Security Objectives Rationale Table for TOE on Either SSR Type I, II, III without External Biometric Sensor and External Pin Pad

	OE.SPCA	OE.IVPS	OE.eID Card	OE.SAM	OE.Service_Attendee	OE.Service_Requester	OE.OCSP	OE.IVS	OE.SSR_Platform	OE.Role_Holder	OE.PC	OE.Security_Management	OE.SAS	OE.Terminal_Cert_Directory	OE.PKI	OE.CM	OE.APS	OE.SSR_Initialization_Environment
T.Counterfeit_eID Card			✓	✓											✓	✓		
T.Revoked_eID Card			✓				✓								✓	✓		
T.Stolen_eID Card			✓		✓	✓			✓									
T.IVA_Fraud				✓				✓							✓	✓		
T.Repudiation			✓			✓									✓	✓		
T.Fake_TOE_to_SR			✓	✓		✓									✓	✓		
T.Fake_TOE_to_External_Entities			✓	✓											✓	✓		
T.Fake_Policy		✓													✓	✓		
T.Fake_OCSP_Response							✓								✓	✓		
T.RH_Comm				✓						✓								
T.RH_Session_Hijack			✓	✓						✓					✓	✓		
T.eIDC_Comm			✓	✓														
T.DTN_Change									✓									
T.SAM-PIN_Theft									✓									
T.Audit_Data_Compromise									✓									

Application Firmware of SSR for eID Verification System

	OE.SPCA	OE.IVPS	OE.eID Card	OE.SAM	OE.Service_Attendee	OE.Service_Requester	OE.OCSP	OE.IVS	OE.SSR_Platform	OE.Role_Holder	OE.PC	OE.Security_Management	OE.SAS	OE.Terminal_Cert_Directory	OE.PKI	OE.CM	OE.APS	OE.SSR_Initialization_Environment
T.TOE_Manipulation									✓									
T.Fake_SAM				✓											✓	✓		
T.Stolen_SAM				✓												✓		
T.Revoked_SAM				✓			✓											
P.TOE_Upgrade	✓			✓									✓				✓	
P.Terminal_Cert_Update														✓		✓		
P.Revocation_Control																✓		
P.Tamper_Response									✓									
A.SPCA	✓																	
A.IVPS		✓																
A.EBS-EPP																		
A.PC											✓							
A.APS																	✓	
A.Management_Environment												✓						
A.SAM_PIN_Environment																		✓
A.SSR_Platform									✓									

Application Firmware of SSR for eID Verification System

TOE on SSR Type II and TOE on SSR Type III adds the Photo Verification mechanism and Service Attendee and Security Service Provider entities. In addition, TOE on SSR Type II adds the SSR Access Server (SAS) related objectives and TOE on SSR Type III adds the Application Server (APS) related objectives. The additions for the coverage of the threats, OCPs and assumptions (that are not valid for Type I) is given in Table 15.

Table 15. Additions to Security Objective Rationale due to differences of SSR Type II, III from SSR Type I

	OT.Photo_Verification	OE.Service_Attendee	OT.SA_Identity_Verification	OT.Session_Ending	OT.SAS_DA	OT.SAS_SC	OT.APS_DA	OT.APS_SC	OE.APS	OE.SAS	OE.PKI	OE.CM	OE.SAM	OE.eID_Card
T.Illegitimate_SAS (SSR Type II)					✓					✓				
T.Illegitimate_APS (SSR Type III)							✓		✓					
T.IVA_Eavesdropping						✓		✓	✓	✓				
T.Fake_TOE_to_External_Entities					✓		✓							
T.Stolen_eIDC	✓	✓												
T.SA_Masquerader		✓	✓								✓	✓	✓	
T.SA_Abuse_of_Session		✓		✓										

For all three types of SSR Device, External Biometric sensor or External PIN Pad could be connected. For the TOE on SSR device connected with an EBS or EPP, the additional threats, OSPs and assumptions are given in

Application Firmware of SSR for eID Verification System

Table 16.

rev: 2.8	date: 01.08.2017	SSR_PP_2.8	56. page of	105pages
----------	------------------	------------	-------------	----------

Application Firmware of SSR for eID Verification System

Table 16. Additions to Security Objective Rationale for TOE on SSR with External/Internal Biometric Sensor and/or EPP

	OT.Biometric_Verification	OT.EPP_DA	OT.EPP_SC	OE.EPP	OE.PKI	OE.CM	OT.EBS_DA	OT.EBS_SC	OE.SAM	OE.EBS
T.Stolen_eIDC	✓									
T.Fake_TOE_to_External_Entities		✓		✓			✓			✓
T.Repudiation	✓									
T.Illegitimate_EPP		✓		✓	✓	✓			✓	
T.EPP_Comm			✓	✓					✓	
T.Illegitimate_EBS					✓	✓	✓		✓	✓
T.EBS_Comm								✓	✓	✓
A.EBS-EPP				✓						✓

Table 17. Additions to Security Objective Rationale for TOE on SSR Type III

	OT.IVA_Privacy	OE.SAM
P.Offline_Operation	✓	
T.IVA_Confidentiality	✓	✓

4.5 SECURITY OBJECTIVES RATIONALE

T.Counterfeit_eID Card: The security objectives OT.eIDC_Authentication and OT.SM_eID Card protect the eID Card against counterfeiting by authentication of the eID Card and Secure Messaging with the card. These mechanisms brings about some requirements on eID card, which is addressed by OE.eID and the support of SAM, which is addressed by OE.SAM. The authentication mechanism requires the public key infrastructure and the secure credential management. The public key infrastructure is addressed by OE.PKI; the security of credential management is addressed by OE.CM. Security Objectives: OT.eIDC_Authentication, OT.SM_eID Card, OT.IVM_Management, OE.eID Card, OE.SAM, OE.PKI, OE.CM

T.Stolen_eID Card: The justification of this threat changes according to the configuration of the TOE.

Table 18. Justification According to The Configuration of TOE

	Without Biometric Sensor (internal or external) and EPP	With Biometric Sensor and EPP
TOE on SSR Type I	OT.PIN_Verification, OE.Service_Requester, OE.eID Card, OE.SSR_Platform.	OT.PIN_Verification, OT.Biometric_Verification OE.Service_Requester, OE.eID Card, OE.SSR_Platform.
Type II and III	OT. PIN_Verification, OT.Photo_Verification, OE.Service_Requester, OE.Service_Attendee, OE.eID Card, OE.SSR_Platform.	OT.PIN_Verification, OT.Photo_Verification, OT.Biometric_Verification, OE.Service_Requester, OE.Service_Attendee, OE.eID Card, OE.SSR_Platform.

At minimum PIN Verification mechanism verifies if the person presenting the card is legitimate owner of the eID Card or an attacker trying to masquerade the identity of legitimate card holder (OT.PIN_Verification addresses the features in the TOE for this operation, OE.eID_Card addresses the eID Card requirements for this operaiton, and OE.Service_Requester addresses the Service Requester requirements for this operaiton). Photo Verification and Biometric Verification strengthens the resistance against the T.Stolen_eID Card. (OT.Biometric_Verification for biometric verification;

Application Firmware of SSR for eID Verification System

OT.Photo_Verification and OE.Service_Attendee for photo verification). In addition to this the SSR Platform shall prevent the attacker to steal the PIN or the biometric data of the user.

Security Objectives: OT.PIN_Verification, OT.Photo_Verification and OT.Biometric_Verification, OE.eID Card, OE.Service_Requester, OE.Service_Attendee, OE.SSR_Platform.

T.Revoked_eID Card: Authentication methods required by OT.IVM_Management prevent the revocation attack on the eID Card. OT.IVM_Management and OE.OCSPS cover the threat.

Security Objectives: OT.IVM_Management, OE.OCSPS, OE.eID Card, OE.PKI, OE.CM.

T.IVA_Fraud: OT.IVA_Signing allows the IVS to verify the IVA and identify the SSR that created the IVA. Hence, if an illegitimate IVA is created by an attacker, the IVS can detect it. The signing of IVA is performed by the SAM. Therefore, the OT.IVA_Signing, OE.SAM and OE.IVS cover the current threat together with OE.PKI and OE.CM which also cover the required PKI and the secure creation and distribution of the credentials and authentication reference data respectively.

Security Objectives: OT.IVA_Signing, OE.SAM, OE.IVS, OE.PKI, OE.CM

T.IVA_Eavesdropping:

OT.APS_SC and OE.APS require the secure communication of the TOE with SAS and APS for SSR for Type III. OT.SAS_SC, and OE.SAS require the secure communication of the TOE with SAS and APS for SSR Type II. Secure communication prevents the attacker to obtain IVA by monitoring the communication.

Hence, T.IVA_Eavesdropping is covered by, OT.SAS_SC, OT.APS_SC, OE.APS and OE.SAS

Security Objectives: OT.APS_SC, OE.APS, OT.SAS_SC, OE.SAS

T.IVA_Confidentiality: OT.IVA_Privacy addresses the secure storage of the IVAs in SSR Type III. The encryption keys are generated by SAM thus OE.SAM addresses the secure storage of this encryption keys. These keys shall be transferred to the TOE via the secure messaging which is addressed by OT.SM_TOE_and_SAM

Security Objectives: OT.IVA_Privacy, OT.SM_TOE_and_SAM, OE.SAM,

T.Repudiation: PIN Verification or Biometric Verification mechanisms ensure that Service Requester and eID Card had joined to the Identification Process. OE.CM covers the secure creation and distribution of the credentials and authentication reference data. Thus OT.PIN_Verification, OT.Biometric_Verification, OE.Service_Requester, OE.eID Card, OE.PKI, and OE.CM cover the T.Repudiation.

Security Objectives: OT.PIN_Verification, OT.Biometric_Verification, OE.Service_Requester, OE.eID Card, OE.PKI and OE.CM

T.Fake_TOE_to_SR: OT.PM_Verification allows the Service Requester identifying a legitimate SSR. OE.Service_Requester protects the service requester from entering his or her PIN and interacting

rev: 2.8	date: 01.08.2017	SSR_PP_2.8	59. page of	105pages
----------	------------------	------------	-------------	----------

Application Firmware of SSR for eID Verification System

with the biometric sensor without Personal Message Verification. OE.eID Card prevents the fake SSR accessing the Personal Message and OE.SAM provides the TOE the ability of proving its identity to the eID Card. Finally, OE.PKI and OE.CM cover the required PKI and the secure creation and distribution of the credentials and authentication reference data.

Security Objectives: OT.PM_Verification, OE.eID Card, OE.Service_Requester, OE.SAM, OE.PKI, OE.CM

T.Fake_TOE_to_External_Entities: Authentication objectives for eID Card, Role Holder, SAS, APS, EBS, EPP are OT.SM_eIDCard, OT.RH_DA, OT.SAS_DA, OT.APS_DA, OT.EBS_DA, OT.EPP_DA correspondingly require TOE to prove its identity before doing any action. SAM card in the SSR Device is used to prove identity of the TOE to the external entities. OE.PKI and OE.CM cover the required PKI and the secure creation and distribution of the credentials and authentication reference data. Thus, OE.SAM covers the threat with OE.eID Card, OE.EBS (depends on the configuration), and OE.EPP (depends on the configuration).

Security Objectives: OT.SM_eIDCard, OT.RH_DA, OT.SAS_DA, OT.APS_DA, OT.EBS_DA, OT.EPP_DA, OE.SAM, OE.eID Card, OE.EBS (depends on the configuration), OE.EPP (depends on the configuration), OE.PKI, OE.CM.

T.SA_Masquerader: OT.SA_Identity_Verification addresses the verification of Service Attendee's identity. Service Attendee's identity verification is similar to the identity verification of Service Requester. OE.eID Card, OE.SAM and the OE.Service_Attender address the necessary contributions of the eID Card, SAM and Service Attendee to the mechanisms covered in Service Attendee identity verification. Finally, OE.PKI and OE.CM cover the required PKI and the secure creation and distribution of the credentials and authentication reference data.

Security Objectives:OT.SA_Identity_Verification, OE.eID Card, OE.SAM OE.Service_Attendee, OE.PKI, OE.CM

T.SA_Abuse_of_Session: OT.Session_Ending addresses the termination of authentication session of Service Attendee whenever the session expires or the Service Attendee removes the eID Card. OE.Service_Attendee states that the Service Attendee shall not leave his or her eID Card when he or she leaves the SRR environment.

Security Objectives: OT.Session_Ending, OE.Service_Attendee

T.Fake_Policy: OT.Identity_Verification_Policy_Authentication addresses verifying the integrity and origin of Identity Verification Policy and OE.IVPS states that Identity Verification Policy shall be signed electronically by the IVPS. OE.PKI and OE.CM cover the required PKI and the secure creation and distribution of the credentials and authentication reference data.

Security Objectives: OT.Identity_Verification_Policy_Authentication, OE.IVPS, OE.PKI, OE.CM

rev: 2.8	date: 01.08.2017	SSR_PP_2.8	60. page of	105pages
----------	------------------	------------	-------------	----------

Application Firmware of SSR for eID Verification System

T.Fake_OCSP_Response: OT.OCSP_Query_Auth addresses verifying the integrity and the origin of the OCSP response. OE.OCSPS states that OCSP response shall be signed by the OCSPS. OE.PKI and OE.CM cover the required PKI mechanism and the secure creation and distribution of the credentials and authentication reference data.

Security Objectives: OT.OCSP_Query_Verify, OE.OCSPS, OE.PKI, OE.CM

T.RH_Comm: The OT.RH_SC, OE.SAM and OE.Role_Holder together agree on the secure communication keys. OT.RH_SC and OE.Role_Holder addresses the secure communication between the Role Holder and the TOE.

Security Objectives: OT.RH_SC, OE.SAM, OE.Role_Holder

T.RH_Session_Hijack: OT.RH_DA [Role Holder Device Authentication], OE.SAM and OE.Role_Holder provides mutual authentication of the TOE and the Role Holder. OT.RH_Session_Ending resets the authentication status of Role Holder in eID Card when the secure communication session is terminated. This prevents the attacker to abuse the authentication status present in the eID Card. OE.eID Card helps the OT.RH_Session_Ending by providing an authentication reset mechanism to the TOE. Finally OE.PKI and OE.CM cover the required PKI mechanism and the secure creation and distribution of the credentials and authentication reference data.

Security Objectives:OT.RH_DA [Role Holder Device Authentication], OT.RH_Session_Ending, OE.Role_Holder, OE.SAM, OE.eID Card, OE.PKI, OE.CM.

T.Illegitimate_EBS: OT.EBS_DA addresses the authentication of EBS by SAM. OE.PKI and OE.CM cover the required PKI mechanism and the secure creation and distribution of the credentials and authentication reference data. So the threat is covered OT.EBS_DA, OE.SAM, OE.EBS, OE.PKI and OE.CM.

Security Objectives: OT.EBS_DA, OE.SAM, OE.EBS, OE.PKI, OE.CM

T.EBS_Comm: OT.EBS_SC and OE.EBS addresses secure communication between the TOE and the EBS. The OE.SAM and OE.EBS contribute to the key agreement protocol between the TOE and the EBS.

Security Objectives: OT.EBS_SC, OE.SAM, OE.EBS

T.Illegitimate_EPP: OT.EPP_DA, OE.EPP and OE.SAM addresses the authentication of EPP by SAM. OE.PKI and OE.CM cover the required PKI mechanism and the secure creation and distribution of the credentials and authentication reference data. So the threat is covered by OT.EPP_DA, OE.SAM, OE.EPP, OE.PKI, and OE.CM.

Security Objectives: OT.EPP_DA, OE.SAM, OE.EPP, OE.PKI, OE.CM

T.EPP_Comm: OT.EPP_SC, OE.EPP and OE.SAM address the secure communication between the TOE and the EPP therefore cover the threat.

rev: 2.8	date: 01.08.2017	SSR_PP_2.8	61. page of	105pages
----------	------------------	------------	-------------	----------

Application Firmware of SSR for eID Verification System

Security Objectives: OT.EPP_SC, OE.EPP, OE.SAM

T.eIDC_Comm: OT.SM_eID Card and OE.eID Card create the cryptographic keys and perform secure communication. OE.SAM supports the cryptographic key agreement between the TOE and the eID Card. Hence the threat is covered by OT.SM_eID Card, OE.eID Card and OE.SAM.

Security Objectives: OT.SM_eID Card, OE.eID Card and OE.SAM.

T.Illegitimate_SAS: This threat is covered by OT.SAS_DA which guarantee the authentication of the SAS before any other action and OE.SAS which ensures that the SAS has the ability to be authenticated by the TOE.

Security Objectives: OT.SAS_DA, OE.SAS.

T.Illegitimate_APS: This threat is covered by OT.APS_DA, which guarantee the authentication of the APS before any other action and OE.APS which ensures that the APS has the ability to be authenticated by the TOE.

Security Objectives: OT.APS_DA, OE.APS.

T.DTN_Change: OT.DTN_Mgmt and OE.SSR_Platform address the protection against unauthorized modification to the DTN.

Security Objectives: OT.DTN_Mgmt, OE.SSR_Platform.

T.SAM-PIN_Theft: OT.Security_Failure, OT.SM_TOE_and_SAM, OE.SSR_Platform and OT.SAM-PIN_Sec address the protection of SAM-PIN against theft and unauthorized change.

Security Objective: OT.Security_Failure, OT.SAM-PIN_Mgmt, OT.SAM-PIN_Sec, OE.SSR_Platform.

T.Audit_Data_Compromise: OT.Security_Failure, OT.Audit_Data_Protection and OE.SSR_Platform cover the protection of audit data from unauthorized change.

Security Objective: OT.Security_Failure, OT.Audit_Data_Protection, OE.SSR_Platform.

T.TOE_Manipulation: OT.Security_Failure addresses protection of the TOE against physical tampering together with OE.SSR_Platform. OT.SM_TOE_and_SAM [Secure Messaging between TOE and SAM], addresses the protection of communication between the SAM and the TOE. OT.SAM-PIN_Sec protects the SAM-PIN against probing, OT.DTN_Integrity protects the DTN from manipulation, and the OT.Audit_Data_Protection protects the audit data from manipulation. OT.RIP provides protection against probing attacks and de-allocates any resources when they are no longer needed.

Security Objectives: OT.SM_TOE_and_SAM [Security between TOE and SAM], OT.SAM-PIN_Sec, OT.DTN_Integrity, OT.Audit_Data_Protection, OT.RIP [Residual Information Protection], OE.SSR_Platform

T.Fake_SAM: OT.Auth_SAM_by_TOE addresses the authentication of SAM by TOE. OE.SAM provides the TOE for the capability to authenticate itself. Finally, OE.PKI and OE.CM cover the required PKI

rev: 2.8	date: 01.08.2017	SSR_PP_2.8	62. page of	105pages
----------	------------------	------------	-------------	----------

Application Firmware of SSR for eID Verification System

mechanism and the secure creation and distribution of the credentials and authentication reference data. Thus OT.Auth_SAM_by_TOE, OE.SAM, OE.PKI, and OE.CM cover the threat.

Security Objectives: OT.Auth_SAM_by_TOE [Authentication of SAM by TOE], OE.SAM, OE.PKI, OE.CM

T.Stolen_SAM: OT.Auth_SAM_by_TOE addresses the authentication of SAM by TOE and OE.SAM requires the SAM-PIN verification before allowing the SSR (the legitimate or the fake) access its services. OT.SAM-PIN_Sec and OT.SM_TOE_and_SAM requires the SAM PIN security during operation of the SSR Device. The OE.CM protects the SAM-PIN during generation and writing to the SAM and the TOE.

Security Objectives: OT.Auth_SAM_by_TOE, OT.SAM-PIN_Sec, OT.SAM-PIN_Mgmt, OT.SM_TOE_and_SAM, OE.SAM and OE.CM.

T.Revoked_SAM: Authentication of SAM by TOE mechanism also involves the revocation query. The OT.Auth_SAM_by_TOE, OE.SAM, OE.OCSP cover the threat.

Security Objectives: OT.Auth_SAM_by_TOE, OE.SAM, OE.OCSPS.

P.IVM_Management: OT. IVM_Management matches the requirement.

Security Objective: OT. IVM_Management

P.TOE_Upgrade: OT.TOE_Upgrade covers the policy together with OE.SPCA, OE.SAM, OE.SAS and OE.APS since the upgrade package could be installed onto the SSR via SPCA, SAS or APS and SAM stores the certificates to validate the upgrade package.

Security Objectives: OT.TOE_Upgrade, OE.SPCA, OE.SAM, OE.SAS, OE.APS.

P.Re-Authentication: OT.Session_Ending requires necessary re-authentications for each authentication session.

Security Objectives: OT.Session_Ending

P.Terminal_Cert_Update: OT.Cert_Update, OE.Terminal_Cert_Directory and OE.CM matches the policy. OE.Terminal_Cert_Directory requires the related server to obtain the updated certificates and OT.Cert_Update covers the update of the certificates by the TOE.

Security Objectives: OT.Cert_Update, OE.Terminal_Cert_Directory and OE.CM.

P.Time_Update: OT.Time_Mgmt matches the time update requirement.

Security Objective: OT.Time_Mgmt

P.Offline_Operation: OT.IVA_Privacy matches the offline identity verification with TOE on SSR Type III.
Security Objective: OT.IVA_Privacy

P.Revocation_Control: OT.eIDC_Authentication defines the offline certificate verification together with OE.CM

Security Objectives: OT.eIDC_Authentication, OE.CM

rev: 2.8	date: 01.08.2017	SSR_PP_2.8	63. page of	105pages
----------	------------------	------------	-------------	----------

Application Firmware of SSR for eID Verification System

P.DPM: OT.DPM addresses the phase management policy of the P.DPM. DTN and PIN writing policy is addressed by OT.DTN_Mgmt and OT.SAM-PIN_Mgmt objectives correspondingly.

Security Objectives: OT.DPM, OT.DTN_Mgmt and OT.SAM-PIN_mgmt

P.Tamper_Response: OT.Security_Failure and OE.SSR_Platform realize the tamper response together.

Security Objectives: OT.Security_Failure, OE.SSR_Platform

A.SPCA: The security objective OE.SPCA covers the assumption.

Security Objective: OE.SPCA

A.IVPS: The security objective OE.IVPS covers the assumption.

Security Objective: OE.IVPS

A.EBS-EPP: OE.EBS and OE.EPP covers the assumption.

Security Objective: OE.EBS, OE.EPP

A.PC:OE.PC covers the assumption

Security Objective: OE.PC

A.APS: The security objective OE.APS covers the assumption.

Security Objective: OE.APS

A.Management_Environment: OE.Security_Management covers the assumption.

Security Objective: OE.Security_Management

A.SAM_PIN_Environment: OE.SSR_Initialization_Environment covers the assumption.

Security Objective: OE.SSR_Initialization_Environment

A.SSR_Platform: OE.SSR_Platform covers the assumption totally.

Security Objective: OE.SSR_Platform

5 EXTENDED COMPONENTS DEFINITION

5.1 FPT_IDA IMPORTED TSF DATA AUTHENTICATION

Family Behavior:

This family requires that the TOE has the ability to verify that the defined imported TSF Data originates from the stated external entity.

Component Leveling:

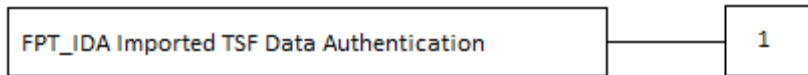

5.1.1 FPT_IDA.1 IMPORTED TSF DATA AUTHENTICATION

Management: FPT_IDA.1

The following actions could be considered for the management functions in FMT:

- Management of authentication data by an administrator.

Audit: FPT_IDA.1

The following actions should be auditable if FAU_GEN Security audit data generation is included in the PP/ST:

- Minimum: The final decision on authentication;

FPT_IDA.1 Imported TSF Data Authentication

Hierarchical to: No other components

Dependencies: No dependencies

FPT_IDA.1.1	The TSF shall verify that the [assignment: list of TSF Data] originates from [assignment: list of external entities] using [assignment: list of authentication mechanisms].
-------------	---

5.2 FPT_SSY STATE SYNCHRONIZATION

Family Behavior:

This family requires that the TOE has ability to synchronize its internal state with another trusted external entity.

Component Leveling:



5.2.1 FPT_SSY.1 STATE SYNCHRONIZATION

Management: FPT_SSY.1

The following actions could be considered for the management functions in FMT:

- Management of conditions where state synchronization is mandatory, not necessary if it fails, or not required

Audit: FPT_SSY.1

The following actions should be auditable if FAU_GEN Security audit data generation is included in the PP/ST:

- Minimum: Result of synchronization: success or failure

FPT_SSY.1 State Synchronization

Hierarchical to: No other components

Dependencies: No dependencies

FPT_SSY.1.1	The TSF shall check [assignment: status of the user security attributes] from the [assignment: the external entities] in times: [assignment: defined periods].
-------------	--

6 SECURITY REQUIREMENTS

6.1 SECURITY FUNCTIONAL REQUIREMENTS

This part of the PP defines the detailed security requirements that shall be satisfied by the TOE. The statement of TOE security requirements shall define the functional and assurance security requirements that the TOE needs to satisfy in order to meet the security objectives for the TOE. The CC allows several operations to be performed on functional requirements; refinement, selection, assignment, and iteration are defined in Section 8.1 of Common Criteria Part1 [17]. The following operations are used in the PP.

The **refinement** operation is used to add detail to a requirement, and thus further restricts a requirement. Refinements of security requirements are denoted in such a way that added words are in **bold text** and removed are ~~crossed out~~.

The **selection** operation is used to select one or more options provided by the CC instating a requirement. Selections having been made are denoted as underlined text.

The **assignment** operation is used to assign a specific value to an unspecified parameter, such as the length of a password. Assignments are denoted by *italicized text*.

The **iteration** operation is used when a component is repeated with varying operations. Iteration is denoted by showing a slash “/”, and the iteration indicator after the component identifier.

6.1.1 CLASS FAU: SECURITY AUDIT

6.1.1.1 FAU_GEN.1 - Audit data generation

Hierarchical to: No other components.

Dependencies: [FPT_STM.1 Reliable time stamps] **fulfilled** by FPT_STM.1

FAU_GEN.1.1	<p>The TSF shall be able to generate an audit record of the following auditable events:</p> <ul style="list-style-type: none"> a) Start-up and shutdown of the audit functions; b) All auditable events for the <u>minimum</u>³ level of audit; and c) <i>Insertion and removal of eID Card and SAM, Service requester authentication, service attendee authentication, start and end of secure messaging, card authentication, received data integrity failure, role holder</i>
-------------	--

³[selection, choose one of: minimum, basic, detailed, not specified]

Application Firmware of SSR for eID Verification System

	<i>authentication, external biometric sensor authentication, external pin pad authentication, SAM authentication, SAM-PIN verification failure, TOE update, IVP verification, OCSP answer verification, Switching to offline mode (for TOE on SSR Type III), SAS authentication and tampering of the SSR⁴.</i>
FAU_GEN.1.2	The TSF shall record within each audit record at least the following information: a) Date and time of the event, type of event , subject identity (if applicable), and the outcome (success or failure) of the event; and b) <i>For each audit event type, based on the auditable event definitions of the functional components included in the PP/ST, reason of the failure (if applicable)⁵.</i>

Configuration Note:

Refinement for TOE on SSR Type I: Exclude the service attendee authentication process.

6.1.1.2 FAU_ARP.1 - Security alarms

Hierarchical to: No other components.

Dependencies: [FAU_SAA.1 Potential violation analysis] **fulfilled** by FAU_SAA.1

FAU_ARP.1.1	The TSF shall take <i>the action of entering Out of Service Mode and delete SAM PIN and Cryptographic Keys used for storage security⁶</i> upon detection of a potential security violation.
-------------	--

Application Note 1: The instantiation "Cryptographic Keys used for storage security" matches the IVA Confidentiality Keys for TOE on SSR Type III with offline working feature.

6.1.1.3 FAU_SAR.1 Audit review

Hierarchical to: No other components.

Dependencies: FAU_GEN.1 Audit data generation

FAU_SAR.1.1	The TSF shall provide [assignment: authorized users] ⁷ with the capability to
-------------	--

⁴[assignment: other specifically defined auditable events]

⁵[assignment: other audit relevant information]

⁶[assignment: list of actions]

Application Firmware of SSR for eID Verification System

	read [assignment: list of audit information] ⁸ from the audit records.
FAU_SAR.1.2	The TSF shall provide the audit records in a manner suitable for the user to interpret the information.

6.1.1.4 FAU_STG.1 - Protected audit trail storage

Hierarchical to: No other components.

Dependencies: [FAU_GEN.1 Audit data generation] **fulfilled** by FAU_GEN.1

FAU_STG.1.1	The TSF shall protect the stored audit records in the audit trail from unauthorized deletion.
FAU_STG.1.2	The TSF shall be able to <u>detect</u> ⁹ unauthorized modifications to the stored audit records in the audit trail.

6.1.1.5 FAU_STG.4 - Prevention of audit data loss

Hierarchical to: FAU_STG.3 Action in case of possible audit data loss.

Dependencies: [FAU_STG.1 Protected audit data storage] **fulfilled** by FAU_STG.1

FAU_STG.4.1	The TSF shall <u>overwrite the oldest stored audit records</u> ¹⁰ and <i>none</i> ¹¹ if the audit trail is full.
-------------	--

6.1.1.6 FAU_SAA.1 - Potential violation analysis

Hierarchical to: No other components.

Dependencies: [FAU_GEN.1 Audit data generation] **fulfilled** by FAU_GEN.1

FAU_SAA.1.1	The TSF shall be able to apply a set of rules in monitoring the audited events and based upon these rules indicate a potential violation of the enforcement of the SFRs.
FAU_SAA.1.2	The TSF shall enforce the following rules for monitoring audited events: a) <i>Tampering of the SSR</i> ¹² known to indicate a potential security violation; b) <i>none</i> ¹³ .

⁷ [assignment: authorized users]

⁸ [assignment: list of audit information]

⁹ [selection, choose one of: prevent, detect]

¹⁰ [selection, choose one of: "ignore audited events", "prevent audited events, except those taken by the authorized user with special rights", "overwrite the oldest stored audit records"]

¹¹ [assignment: other actions to be taken in case of audit storage failure]

¹²[assignment: subset of defined auditable events]

6.1.2 CLASS FCS: CRYPTOGRAPHIC SUPPORT

6.1.2.1 FCS_CKM.1/SM - Cryptographic key generation for secure messaging with eID, SA, EBS, EPP and Role Holder

Hierarchical to: No other components.

Dependencies: [FCS_CKM.2 Cryptographic key distribution, or FCS_COP.1 Cryptographic operation]
fulfilled by FCS_COP.1/AES-CBC and FCS_COP.1/AES-CMAC
 [FCS_CKM.4 Cryptographic key destruction] **fulfilled** by FCS_CKM.4

FCS_CKM.1.1	The TSF shall generate cryptographic keys in accordance with a specified cryptographic key generation algorithm <i>Encryption and CMAC Key Generation Algorithm for Secure Messaging</i> ¹⁴ and specified cryptographic key sizes <i>256 bits</i> ¹⁵ that meet the following: <i>TS 13584 [3]</i> ¹⁶ .
-------------	---

Application Note 2: Above mentioned Secure Messaging are founded between TOE and eID; TOE and SAM; TOE and EBS (if applicable); TOE and EPP (if applicable); TOE and Role Holder.

6.1.2.2 FCS_CKM.1/SM_TLS - Cryptographic key generation for secure messaging with Identity Verification Server, Application Server and SSR Access Server

Hierarchical to: No other components.

Dependencies: [FCS_CKM.2 Cryptographic key distribution, or FCS_COP.1 Cryptographic operation]
fulfilled by FCS_COP.1/AES-CBC and FCS_COP.1/AES-CMAC
 [FCS_CKM.4 Cryptographic key destruction] **fulfilled** by FCS_CKM.4

FCS_CKM.1.1	The TSF shall generate cryptographic keys in accordance with a specified cryptographic key generation algorithm <i>TLS v1.2 or above</i> ¹⁷ and specified cryptographic key sizes <i>256 Bits</i> ¹⁸ that meet the following: <i>RFC 5246</i> ¹⁹ .
-------------	---

Application Note 3: TLS Key Generation is performed between TOE and APS for TOE on SSR Type III; between TOE and SAS for TOE on SSR Type II.

13[assignment: any other rules].

14[assignment: cryptographic key generation algorithm]

15[assignment: cryptographic key sizes]

16[assignment: list of standards]

17[assignment: cryptographic key generation algorithm]

18[assignment: cryptographic key sizes]

19[assignment: list of standards]

6.1.2.3 FCS_CKM.1/IVA_Keys - Cryptographic key generation for IVA Confidentiality

Hierarchical to: No other components.

Dependencies: [FCS_CKM.2 Cryptographic key distribution, or FCS_COP.1 Cryptographic operation]

fulfilled by FCS_COP.1/AES-CBC and FCS_COP.1/AES-CMAC

[FCS_CKM.4 Cryptographic key destruction] **fulfilled** by FCS_CKM.4

FCS_CKM.1.1	The TSF shall generate cryptographic keys in accordance with a specified cryptographic key generation algorithm <i>True Random Number Generation</i> ²⁰ and specified cryptographic key sizes <i>256 bits</i> ²¹ that meet the following: <i>none</i> ²² .
-------------	---

Application Note 4: True Random Numbers should be generated by the SAM. Since the communication between the TOE and the SAM is secure, these keys are securely transferred to the TOE and stored in the tamper proof area.

Refinement: Keys above refers to IVA Encryption/Decryption key used in AES CBC algorithm and the IVA Integrity key used in AES CMAC algorithm. These keys are used to Encrypt/Decrypt the stored IVAs on SSR Type III.

Application Note 5: FCS_CKM.1/IVA_Keys defined above should be included in the ST if only the TOE is on SSR Type III and includes the optional offline IVA Generation and Storage use case.

6.1.2.4 FCS_CKM.4 - Cryptographic key destruction

Hierarchical to: No other components.

Dependencies: [FDP_ITC.1 Import of user data without security attributes, or FDP_ITC.2 Import of user data with security attributes, or FCS_CKM.1 Cryptographic key generation]

fulfilled by FCS_CKM.1/SM, FCS_CKM.1/IVA_Keys and FCS_CKM.1/SM_TLS

FCS_CKM.4.1	The TSF shall destroy cryptographic keys in accordance with a specified cryptographic key destruction method [assignment: cryptographic key destruction method] ²³ that meets the following: [assignment: list of standards] ²⁴ .
-------------	---

20[assignment: cryptographic key generation algorithm]

21[assignment: cryptographic key sizes]

22[assignment: list of standards]

23[assignment: cryptographic key destruction method]

24[assignment: list of standards]

Application Firmware of SSR for eID Verification System

Application Note 6: The dependency of FCS_CKM.4 is satisfied by the FCS_CKM.1/SM, FCS_CKM.1/IVA_Keys and FCS_CKM.1/SM_TLS. Note here that the coverage of these SFRs differs according to SSR Type and whether EBS, EPP and offline modes are included. Therefore, FCS_CKM.4 is required only for the covered SSR Configuration just as it is for FCS_CKM.1.

Application Note 7: FCS_CKM.4 determines the key destruction method for the secure messaging keys, secure storage keys and the Upgrade Package key (the decrypted key). In case there are different key destruction algorithms for different keys (e.g. secure messaging with SAM and secure messaging with role owner), each different key destruction method shall be given in the ST as a different iteration.

6.1.2.5 FCS_COP.1/SHA-256 - Cryptographic operation SHA 256

Hierarchical to: No other components.

Dependencies: [FDP_ITC.1 Import of user data without security attributes, or FDP_ITC.2 Import of user data with security attributes, or FCS_CKM.1 Cryptographic key generation] **not fulfilled** but justified.

[FCS_CKM.4 Cryptographic key destruction] **not fulfilled** but justified.

Justification: A hash function does not use a key so there is neither need to create nor need to destroy.

FCS_COP.1.1	The TSF shall perform <i>hash value calculation</i> ²⁵ in accordance with a specified cryptographic algorithm <i>SHA-256</i> [5] ²⁶ and cryptographic key sizes <i>none</i> ²⁷ that meet the following: <i>FIPS 180-4</i> ²⁸ .
-------------	--

6.1.2.6 FCS_COP.1/AES-CBC - Cryptographic AES CBC operation

Hierarchical to: No other components.

Dependencies: [FDP_ITC.1 Import of user data without security attributes, or FDP_ITC.2 Import of user data with security attributes, or FCS_CKM.1 Cryptographic key generation] **fulfilled** by FCS_CKM.1/SM, FCS_CKM.1/IVA_Keys, FCS_CKM.1/SM_TLS

[FCS_CKM.4 Cryptographic key destruction] **fulfilled** by FCS_CKM.4

Justification: The first dependency is not satisfied for the decryption requirement for the TOE Upgrade package. The encrypted keys of the TOE Upgrade package are installed onto

²⁵[assignment: list of cryptographic operations]

²⁶[assignment: cryptographic algorithm]

²⁷[assignment: cryptographic key sizes]

²⁸[assignment: list of standards]

Application Firmware of SSR for eID Verification System

the TOE together with the Upgrade Package. The Key Decryption Keys for these keys are stored in the SAM. Therefore encrypted keys are decrypted in the SAM using the Key Decryption Keys and used in the TOE.

FCS_COP.1.1	The TSF shall perform <i>encryption and decryption</i> ²⁹ in accordance with a specified cryptographic algorithm <i>AES-256 CBC Mode</i> ³⁰ and cryptographic key sizes <i>256 bits</i> ³¹ that meet the following: <i>FIPS 197 (for AES) [6], NIST Recommendation for Block Cipher Modes of Operations (for CBC mode)[7]</i> ³² .
-------------	--

6.1.2.7 FCS_COP.1/AES-CMAC - Cryptographic CMAC operation

Hierarchical to: No other components.

Dependencies: [FDP_ITC.1 Import of user data without security attributes, or FDP_ITC.2 Import of user data with security attributes, or FCS_CKM.1 Cryptographic key generation] **fulfilled** by FCS_CKM.1/SM, FCS_CKM.1/IVA_Keys, FCS_CKM.1/SM_TLS.
[FCS_CKM.4 Cryptographic key destruction] **fulfilled** by FCS_CKM.4.

FCS_COP.1.1	The TSF shall perform <i>message authentication</i> ³³ in accordance with a specified cryptographic algorithm <i>AES-CMAC</i> ³⁴ and cryptographic key sizes <i>256 bits</i> ³⁵ that meet the following: <i>FIPS 197 (for AES) [6], RFC 4493 (for CMAC operation) [9]</i> ³⁶ .
-------------	--

6.1.2.8 FCS_COP.1/RSA - Cryptographic RSA encryption operation

Hierarchical to: No other components.

Dependencies: [FDP_ITC.1 Import of user data without security attributes, or FDP_ITC.2 Import of user data with security attributes, or FCS_CKM.1 Cryptographic key generation] **not fulfilled** but justified.
[FCS_CKM.4 Cryptographic key destruction] **fulfilled** by FCS_CKM.4

Justification: RSA encryption operation is performed during the key agreement between the SAM and the TOE. Certificate of the secure messaging between the TOE and the SAM is

29[assignment: list of cryptographic operations]

30[assignment: cryptographic algorithm]

31[assignment: cryptographic key sizes]

32[assignment: list of standards]

33[assignment: list of cryptographic operations]

34[assignment: cryptographic algorithm]

35[assignment: cryptographic key sizes]

36[assignment: list of standards]

Application Firmware of SSR for eID Verification System

stored in the SAM. This certificate contains the public RSA key needed for this RSA encryption operation and is read by the TOE before key agreement process starts.

FCS_COP.1.1	The TSF shall perform <i>encryption</i> ³⁷ in accordance with a specified cryptographic algorithm <i>RSA OAEP</i> ³⁸ and cryptographic key sizes <i>2048</i> ³⁹ that meet the following: <i>TS 13584 [3]</i> , and <i>RSA Cryptography Standard [10]</i> ⁴⁰ .
-------------	---

6.1.2.9 FCS_COP.1/Sign_Ver - Cryptographic signature verification operation

Hierarchical to: No other components.

Dependencies: [FDP_ITC.1 Import of user data without security attributes, or FDP_ITC.2 Import of user data with security attributes, or FCS_CKM.1 Cryptographic key generation] **not fulfilled** but justified.

[FCS_CKM.4 Cryptographic key destruction] **not fulfilled** but justified.

Justification: The public key needed to perform the cryptographic operation is imported to the TOE via FPT_IDA.1/X509. So neither key creation nor import operation is necessary within the SFR. Also the public key used in the operation does not have confidentiality requirements so FCS_CKM.4 is also not required here.

FCS_COP.1.1	The TSF shall perform <i>Signature Verification by Cryptographic Validation and Certificate Validation</i> ⁴¹ in accordance with a specified cryptographic algorithm <i>RSA, PKCS#1 v2.1 with PSS padding method</i> ⁴² and cryptographic key sizes <i>2048</i> ⁴³ that meet the following: <i>ETSI TS 102 853[12] and TS 13584 [3]</i> ⁴⁴ .
-------------	--

Application Note 8: This signature verification shall be done for the following signature verification operations:

- verification of Identity Verification Certificate (eID Card Certificate),
- verification of the OCSP Answer signature,

37 [assignment: list of standards]

38 [assignment: cryptographic algorithm]

39 [assignment: cryptographic key sizes]

40 [assignment: list of standards]

41[assignment: list of cryptographic operations]

42[assignment: cryptographic algorithm]

43[assignment: cryptographic key sizes]

44[assignment: list of standards]

Application Firmware of SSR for eID Verification System

- verification of the Signature of the Identity Verification Policy sent by the Identity Verification Policy Server (IVPS) and,
- verification of the Secure Access Module (SAM) certificate,
- verification of upgrade package signature.

Other required signature verification operations required according to the additions to TOE shall be added in the ST.

6.1.3 CLASS FIA: IDENTIFICATION AND AUTHENTICATION

6.1.3.1 FIA_AFL.1 Authentication failure handling

Hierarchical to: No other components.

Dependencies: [FIA_UAU.1 Timing of authentication] fulfilled by FIA_UAU.2, which is hierarchic to FIA_UAU.1

FIA_AFL.1.1	The TSF shall detect when <i>limit of Biometric Verification Failure (defined in TS 13584 [3]) times</i> ⁴⁵ unsuccessful authentication attempts occur related to <i>Biometric Verification</i> ⁴⁶ .
FIA_AFL.1.2	When the defined number of unsuccessful authentication attempts has been <i>met</i> ⁴⁷ , the TSF shall not allow <i>further biometric verification</i> ⁴⁸ .

Application Note 9: Unsuccessful biometric verification number is written into the eID Card by the TOE and updated each time the counter is changed.

6.1.3.2 FIA_UID.2 User Identification before any action

Hierarchical to: No other components.

Dependencies: No dependencies

FIA_UID.2.1	The TSF shall require each user to be successfully identified before allowing any other TSF-mediated actions on behalf of that user.
-------------	--

Refinement: User above refers to Role Holder, Secure Access Module, External PIN Pad (if applicable), External Biometric Sensor (if applicable) and eID Card. In addition, for TOE on SSR Type II user also refers to SAS, for TOE on SSR Type III user also refers to APS.

45[selection: [assignment: positive integer number], an administrator configurable positive integer within[assignment: range of acceptable values]]

46[assignment: list of authentication events]

47[selection: met, surpassed]

48[assignment: list of actions]

6.1.3.3 FIA_UAU.2 User authentication before any action

Hierarchical to: FIA_UAU.1.

Dependencies: [FIA_UID.1 Timing of identification] fulfilled by FIA_UID.2 which is hierarchic to FIA_UID.1

FIA_UAU.2.1	The TSF shall require each user to be successfully authenticated before allowing any other TSF-mediated actions on behalf of that user.
-------------	---

Refinement: User above refers to Role Holder, Secure Access Module, External PIN Pad (if applicable), External Biometric Sensor (if applicable) and eID Card. In addition, for TOE on SSR Type II user also refers to SAS, for TOE on SSR Type III user also refers to APS.

6.1.3.4 FIA_UAU.5 Multiple authentication mechanisms

Hierarchical to: No other components.

Dependencies: No dependencies.

FIA_UAU.5.1	<p>The TSF shall provide <i>the following authentication mechanisms:</i></p> <ul style="list-style-type: none"> • <i>Service Attendee authentication,</i> • <i>Service Requester authentication,</i> • <i>eID Card authentication,</i> • <i>SAM authentication,</i> • <i>Role Holder Device authentication,</i> • <i>SAS authentication for TOE on SSR Type II,</i> • <i>APS authentication for TOE on SSR Type III,</i> • <i>external PIN Pad authentication (if applicable),</i> • <i>external biometric sensor authentication (if applicable)⁴⁹</i> <p>to support user authentication.</p>
FIA_UAU.5.2	<p>The TSF shall authenticate any user's claimed identity according to the following rules:</p> <ul style="list-style-type: none"> • <i>Service requester authentication is done by methods defined in TS 13585 [4]. Verification method is determined by the Identity Verification Policy Server (IVPS) or the Client Application. For the cases when there is</i>

⁴⁹[assignment: list of multiple authentication mechanisms]

Application Firmware of SSR for eID Verification System

	<p><i>no IVPS and Client Application does not determine the method, default method shall be used which is the combination of certificate verification, PIN authentication, photo verification (if applicable) and biometric verification (if applicable) as defined in TS 13585 [4].</i></p> <ul style="list-style-type: none"> • <i>Service Attendee authentication is done by methods defined in TS TS 13585 [4]. Verification method is determined by the Identity Verification Policy Server (IVPS) or the Client Application. For the cases when there is no IVPS and Client Application does not determine the method, default method shall be used which is the combination of certificate verification, PIN authentication and biometric verification (if applicable) as defined in TS 13585 [4].</i> • <i>eID Card, SAM, Role Holder, external PIN Pad and external biometric sensor authentications are done by certificate verification.</i> • <i>APS and SAS authentication are done by SSL/ TLS certificate authentication. SAS verification is a mutual authentication started by the TOE. APS verification is a one way server authentication⁵⁰.</i>
--	---

Refinement: User above refers to Secure Access Module, External PIN Pad, External Biometric Sensor, Service Requester, Service Attendee, eID Card. In addition, for TOE on SSR Type II user also refers to SAS, for TOE on SSR Type III user also refers to IVPS and APS.

Refinement for TOE on SSR Type I: Exclude the Photo Verification and Service Attendee Authentication.

Refinement for TOE on SSR with no external biometric sensor: Exclude the external biometric sensor authentication.

Refinement for TOE on SSR with no external PIN Pad: Exclude the external PIN Pad authentication.

Application Note 10: Certificates stored in the SAM are used for the SSL/ TLS client authentication.

Application Note 11: eID Card is the smart card with the eID Application. Card holder (either Service Requester or the Service Attendee) is the person who possesses the eID Card. The authentication of the eID Card and the Card Holder are handled separately because the former is to validate that the card is not counterfeit, not forged or not revoked and the latter is to validate that the card is not stolen. However, due to the authentication policy, in some cases Service Attendee and Service Requester authentication consist of certificate verification. In this case one refers to the other.

⁵⁰[assignment: rules describing how the multiple authentication mechanisms provide authentication]

6.1.3.5 FIA_UAU.6 - Re-authenticating

Hierarchical to: No other components.

Dependencies: No dependencies.

FIA_UAU.6.1	<p>The TSF shall re-authenticate the user under the conditions given below.</p> <p>When 4 hours is exceeded after Service Attendee authentication, this authentication process is repeated.</p> <ul style="list-style-type: none"> • In each authentication request for Service Requester, Service Requester is re-authenticated even if the card is not removed. <p><i>After 24 hours are exceeded the following sessions' keys are renewed:</i></p> <ul style="list-style-type: none"> • <i>SAM authentication,</i> • <i>Role Holder Device authentication,</i> • <i>APS authentication for TOE on SSR Type III,</i> • <i>SAS authentication for TOE on SSR Type II</i> • <i>external PIN Pad authentication (if applicable),</i> • <i>external biometric sensor authentication (if applicable)⁵¹.</i>
-------------	--

Refinement for TOE on SSR Type I: Exclude the Photo Verification and Service Attendee Authentication

Refinement: User above refers to Service Attendee, Service Requester, SAM, Role Holder, APS for TOE on SSR Type III, SAS for TOE on SSR Type II, EPP (if applicable) or EBS (if applicable) according to the context.

6.1.3.6 FIA_UAU.7 Protected authentication feedback

Hierarchical to: No other components.

Dependencies: [FIA_UAU.1 Timing of authentication] fulfilled by FIA_UAU.2, which is hierarchical to FIA_UAU.1.

FIA_UAU.7.1	<p>The TSF shall provide</p> <ul style="list-style-type: none"> • <i>a dummy character for each entered PIN entry for authentication by PIN</i> • <i>a dummy fingerprint representation for authentication by biometry</i>
-------------	--

⁵¹[assignment: list of conditions under which re-authentication is required]

Application Firmware of SSR for eID Verification System

	<p>on the SSR screen⁵² to the user Service Requester or Service Attendee while the authentication is in progress.</p>
--	--

6.1.4 CLASS FCO: COMMUNICATION

6.1.4.1 FCO_NRO.2 Enforced proof of origin for Identity Verification Assertion

Hierarchical to: Selective proof of origin.

Dependencies: [FIA_UID.1 Timing of identification] fulfilled by FIA_UID.1

FCO_NRO.2.1	The TSF shall enforce the generation of evidence of origin for transmitted <i>Identity Verification Assertion Data</i> ⁵³ at all times.
FCO_NRO.2.2	The TSF shall be able to relate the <i>identity of origin</i> ⁵⁴ of the originator of the information, and the <i>Identity Verification Assertion Data</i> ⁵⁵ of the information to which the evidence applies.
FCO_NRO.2.3	The TSF shall provide a capability to verify the evidence of origin of information to <i>Identity Verification Server</i> ⁵⁶ given <i>immediately in online mode, within a 24 hours period in offline mode for TOE on SSR Type III</i> ⁵⁷ .

Refinement: Evidence above shall be the signature of the SAM card. Before sending the Identity Verification Assertion (IVA) to the Identity Verification Server (IVS), TOE shall ensure that the Identity Verification Assertion Data is signed by the SAM Signature Certificate as defined in TS 13584 [3].

Application Note 12: - IVS verifies the IVA. This is why the assignment is instantiated as “*Identity Verification Server*”. However, TOE on SSR Type I and Type II gives the IVA to SPCA and SPCA sends the IVA to APS. TOE on SSR Type III directly sends the IVA to APS. In all cases APS sends the IVA to IVS.

6.1.5 CLASS FMT: SECURITY MANAGEMENT

6.1.5.1 FMT_MOF.1 /Verify- Management of security functions behavior - verify

Hierarchical to: No other components.

Dependencies: [FMT_SMR.1 Security roles] **fulfilled** by FMT_SMR.1

52[assignment: list of feedback]

53 [assignment: list of information types]

54 [assignment: list of attributes]

55 [assignment: list of information fields]

56 [assignment: list of third parties]

57 [assignment: limitations on the evidence of receipt]

Application Firmware of SSR for eID Verification System

[FMT_SMF.1 Specification of Management Functions] **fulfilled** by FMT_SMF.1

FMT_MOF.1.1	The TSF shall restrict the ability to <u>determine the behavior of</u> ⁵⁸ the function <i>Identity Verification Operation</i> ⁵⁹ to the <i>Identity Verification Policy Server or Client Application</i> ⁶⁰ .
-------------	--

Application Note 13 A default Identity Verification Method shall be defined in the TOE during production for the cases when this method is not determined by IVPS or Client Application.

6.1.5.2 FMT_MOF.1 /Upgrade-Management of security functions behavior - upgrade

Hierarchical to: No other components.

Dependencies: [FMT_SMR.1 Security roles] **fulfilled** by FMT_SMR.1

[FMT_SMF.1 Specification of Management Functions] **fulfilled** by FMT_SMF.1

FMT_MOF.1.1	The TSF shall restrict the ability to <u>enable</u> ⁶¹ the function <i>TOE Upgrade</i> ⁶² to <i>Client Application for TOE on Type I and Type II, Application Server for TOE on Type III and Manufacturer service operator</i> ⁶³ .
-------------	--

Refinement: TOE Upgrade above shall be allowed only for the higher versions and the Upgrade Package shall be associated with the SAM in the corresponding SSR.

6.1.5.3 FMT_MTD.1/SAM-PIN Management of TSF data

Hierarchical to: No other components.

Dependencies: [FMT_SMR.1 Security roles] fulfilled by FMT_SMR.1

[FMT_SMF.1 Specification of Management Functions] fulfilled by FMT_SMF.1

FMT_MTD.1.1	The TSF shall restrict the ability to <u>write</u> ⁶⁴ the <i>SAM-PIN</i> ⁶⁵ to <i>Initialization Agent</i> ⁶⁶ .
-------------	--

6.1.5.4 FMT_MTD.1/DTN Management of TSF data - Device Tracking Number

Hierarchical to: No other components.

58[selection: determine the behavior of, disable, enable, modify the behavior of]

59[assignment: list of functions]

60[assignment: the authorized identified roles]

61[selection: determine the behavior of, disable, enable, modify the behavior of]

62[assignment: list of functions]

63[assignment: the authorized identified roles]

64[selection: change_default, query, modify, delete, clear, [assignment: other operations]]

65[assignment: list of TSF data]

66[assignment: the authorized identified roles]

Application Firmware of SSR for eID Verification System

Dependencies: FMT_SMR.1 Security roles **fulfilled** by FMT_SMR.1

FMT_SMF.1 Specification of Management Functions **fulfilled** by FMT_SMF.1

FMT_MTD.1.1	The TSF shall restrict the ability to <u>write</u> ⁶⁷ the <i>Device Tracking Number</i> ⁶⁸ to <i>Initialization Agent</i> ⁶⁹ .
-------------	---

6.1.5.5 FMT_MTD.1/Time Management of TSF data -Time

Hierarchical to: No other components.

Dependencies: FMT_SMR.1 Security roles **fulfilled** by FMT_SMR.1

FMT_SMF.1 Specification of Management Functions **fulfilled** by FMT_SMF.1

FMT_MTD.1.1	The TSF shall restrict the ability to <u>update</u> ⁷⁰ the <i>Time</i> ⁷¹ to <i>OCSP server</i> ⁷² .
-------------	---

Application Note 14: TOE gets the time information from OCSP Server and stores this time information on the SSR real time Clock (RTC). Upon use of time information in TSF functions, RTC provides time information.

6.1.5.6 FMT_SMF.1 Specification of Management Functions

Hierarchical to: No other components.

Dependencies: No dependencies.

FMT_SMF.1.1	The TSF shall be capable of performing the following management functions: <ul style="list-style-type: none">• <i>TOE initialization (including SAM PIN and DTN initialization),</i>• <i>TOE upgrade,</i>• <i>time and date setting,</i>• <i>audit generation,</i>• <i>identity verification method determination</i>⁷³.
-------------	---

67[selection: change_default, query, modify, delete, clear, [assignment: other operations]]

68[assignment: list of TSF data]

69[assignment: the authorized identified roles]

70[selection: change_default, query, modify, delete, clear, [assignment: other operations]]

71[assignment: list of TSF data]

72[assignment: the authorized identified roles]

73[assignment: list of management functions to be provided by the TSF]

6.1.5.7 FMT_SMR.1 Security roles

Hierarchical to: No other components.

Dependencies: FIA_UID.1 Timing of identification **fulfilled** by FIA_UID.2 which is hierarchic to FIA_UID.1

FMT_SMR.1.1	<p>The TSF shall maintain the roles</p> <ul style="list-style-type: none"> • <i>Initialization Agent,</i> • <i>SSR Access Server for TOE on SSR Type II,</i> • <i>Client Application for TOE on Type I and Type II,</i> • <i>Application Server for TOE on Type III,</i> • <i>Identity Verification Policy Server,</i> • <i>OCSP Server,</i> • <i>Manufacturer service operator</i> • <i>Software Publisher</i>⁷⁴.
FMT_SMR.1.2	The TSF shall be able to associate users with roles.

6.1.6 CLASS FPT: PROTECTION OF THE TSF

6.1.6.1 FPT_STM.1 Reliable Time Stamps

Hierarchical to: No other components

Dependencies: No dependencies

FPT_STM.1.1	The TSF shall be able to provide reliable time stamps.
-------------	--

Refinement: Reliable time stamp shall be provided from the OCSP server and stored in a real time clock on SSR Device.

6.1.6.2 FPT_IDA.1/CVC – Imported TSF Data Authentication - Card Verifiable Certificates

Hierarchical to: No other components

Dependencies: No dependencies

FPT_IDA.1.1	<p>The TSF shall verify that the <i>Secure Messaging Card Verifiable Certificates and Role Card Verifiable Certificates</i>⁷⁵ originates from <i>Card Publisher</i>⁷⁶ using <i>CVC Authentication Mechanism defined in TS 13584 [3]</i>⁷⁷.</p>
-------------	---

⁷⁴[assignment: the authorized identified roles]

6.1.6.3 FPT_IDA.1/X509 - Imported TSF Data Authentication – X509 Certificates

Hierarchical to: No other components

Dependencies: No dependencies

FPT_IDA.1.1	The TSF shall verify that the <i>Identity Verification Certificate, Identity Verification Policy Server Certificate, OCSP Server Certificate, Software Publisher Certificate</i> ⁷⁸ originates from <i>Card Publisher and Device Manager</i> ⁷⁹ using <i>X509 Certificate Authentication Mechanism defined in TS 13584 [3]</i> ⁸⁰ .
-------------	--

6.1.6.4 FPT_IDA.1/IVP - Imported TSF Data Authentication - Identity Verification Policy

Hierarchical to: No other components

Dependencies: No dependencies

FPT_IDA.1.1	The TSF shall verify that the <i>Identity Verification Policy</i> ⁸¹ originates from <i>Identity Verification Policy Server</i> ⁸² using <i>IVP authentication mechanism defined in TS 13584 [3]</i> ⁸³ .
-------------	--

6.1.6.5 FPT_IDA.1/OCSP Imported TSF Data Authentication - OCSP

Hierarchical to: No other components

Dependencies: No dependencies

FPT_IDA.1.1	The TSF shall verify that the <i>OCSP Response</i> ⁸⁴ originates from legitimate <i>OCSP Server</i> ⁸⁵ using <i>OCSP Response Verification Mechanism defined TS 13584 [3]</i> ⁸⁶ .
-------------	---

Application Note 15: For offline Revocation Status Control from the Revocation List downloaded onto the SSR Device this verification mechanism is still valid.

75[assignment: list of TSF Data]
 76[assignment: list of external entities]
 77[assignment: list of authentication mechanisms].
 78[assignment: list of TSF Data]
 79[assignment: list of external entities]
 80[assignment: list of authentication mechanisms].
 81[assignment: list of TSF Data]
 82[assignment: list of external entities]
 83[assignment: list of authentication mechanisms].
 84[assignment: list of TSF Data]
 85[assignment: list of external entities]
 86[assignment: list of authentication mechanisms].

6.1.6.6 FPT_IDA.1/TOE_Upgrade - Imported TSF Data Authentication - TOE Upgrade Package

Hierarchical to: No other components

Dependencies: No dependencies

FPT_IDA.1.1	The TSF shall verify that the <i>TOE upgrade package</i> ⁸⁷ originates from <i>legitimate Software Publisher</i> ⁸⁸ using <i>TOE Upgrade Authentication mechanism defined in TS 13584 [3]</i> ⁸⁹ .
-------------	---

6.1.6.7 FPT_SSY.1/Cert State Synchronization -Secure Messaging and Role CVC

Hierarchical to: No other components

Dependencies: No dependencies

FPT_SSY.1.1	The TSF shall check <i>the validity of the Secure Messaging and Role Card Certificates of the SAM</i> ⁹⁰ and request updated certificates from the: <ul style="list-style-type: none"> • <i>SPCA for TOE on SSR Type I and Type II with no SAS</i> • <i>SAS for TOE on SSR Type II with SAS</i> • <i>APS for TOE on SSR Type III</i>⁹¹ in times: <i>at each Identity Verification Operation</i> ⁹² .
-------------	---

6.1.6.8 FPT_SSY.1/SAM State Synchronization -SAM

Hierarchical to: No other components

Dependencies: No dependencies

FPT_SSY.1.1	The TSF shall check <i>SAM Card Certificate revocation status</i> ⁹³ from the <i>OCSP Server</i> ⁹⁴ in times: <i>immediately after opening of the SSR</i> ⁹⁵ .
-------------	---

6.1.6.9 FPT_SSY.1/IVC State Synchronization -IVC

Hierarchical to: No other components

Dependencies: No dependencies

87[assignment: list of TSF Data]
 88[assignment: list of external entities]
 89[assignment: list of authentication mechanisms].
 90[assignment: security attributes]
 91[assignment: the external entities]
 92 [assignment: defined periods]
 93[assignment: security attributes]
 94[assignment: the external entities]
 95 [assignment: defined periods]

Application Firmware of SSR for eID Verification System

FPT_SSY.1.1	The TSF shall check <i>Identity Verification Certificate revocation status</i> ⁹⁶ from the <i>OCSP Server or SSR Platform on which up-to-date Revocation List is present</i> ⁹⁷ in times: <i>during Identity Verification Operation</i> .
-------------	---

Application Note 16: The instantiation of the assignment operation with "SSR Platform on which up-to-date Revocation List is present" should be included in the ST only if the TOE has the capability of offline Revocation Control, i.e. downloads the revocation list onto SSR device and do offline revocation controls. If a new update is present for the revocation list but the OSCP is not reached, in this case the foundation giving the service is responsible for defining the time for using old revocation list

6.1.6.10 FPT_SSY.1/RH_Auth_Status State Synchronization Role Holder Authentication Status

Hierarchical to: No other components

Dependencies: No dependencies

FPT_SSY.1.1	The TSF shall check <i>Role Holder authentication status in eID Card</i> ⁹⁸ from the <i>eID Card</i> ⁹⁹ in times: <i>after the secure communication between Role Holder and the TSF is terminated</i> ¹⁰⁰ .
-------------	--

Application Note 17: The TSF shall reset the authentication status of the Role Holder in eID Card after the secure communication between Role Holder and the TSF is terminated as defined in TS 13584 [3]

6.1.6.11 FPT_TST.1 TSF testing

Hierarchical to: No other components.

Dependencies: No dependencies.

FPT_TST.1.1	The TSF shall run a suite of self tests <u>during initial start-up</u> ¹⁰¹ to demonstrate the correct operation of <u>the TSF</u> ¹⁰² .
FPT_TST.1.2	The TSF shall provide authorized users with the capability to verify the

96[assignment: security attributes]

97[assignment: the external entities]

98[assignment: security attributes]

99[assignment: the external entities]

100 [assignment: defined periods]

101[selection: during initial start-up, periodically during normal operation, at the request of the authorized user, at the conditions[assignment: conditions under which self-test should occur]]

102[selection: [assignment: parts of TSF], the TSF].

Application Firmware of SSR for eID Verification System

	integrity of [selection: [assignment: parts of TSF data], TSF data ¹⁰³ .
FPT_TST.1.3	The TSF shall provide authorized users with the capability to verify the integrity of [selection: [assignment: parts of TSF], TSF].

6.1.6.12 FPT_FLS.1 Failure with preservation of secure state

Hierarchical to: No other components.

Dependencies: No dependencies.

FPT_FLS.1.1	The TSF shall preserve a secure state when the following types of failures occur: <i>a tampering event is detected, identification and authentication services for SAM are disturbed</i> ¹⁰⁴ .
-------------	---

6.1.7 CLASS FDP: USER DATA PROTECTION

6.1.7.1 FDP_IFC.1 Subset Information Flow Control

Hierarchical to: No other components

Dependencies: FDP_IFF.1 Simple security attributes fulfilled by FDP_IFF.1

FDP_IFC.1.1	<p>The TSF shall enforce the <i>Information Flow Control Policy</i>¹⁰⁵ on :</p> <p><i>Subjects:</i></p> <p><i>SPCA (subject of TOE on SSR Type I and SSR Type II), SAS (subject for TOE on SSR Type II with SAS), APS (subject for TOE on SSR Type III), OCSP Server for TOE on SSR Type III, IVPS for SSR Type III.</i></p> <p><i>Information:</i></p> <p><i>TOE Upgrade Package, IVA, IVM, OCSP response, SAM Secure Messaging CVC and SAM Role CVC</i></p> <p><i>Operations:</i></p> <p><i>Write (installed to the TOE), read (sent by the TOE)</i>¹⁰⁶.</p>
-------------	--

6.1.7.2 FDP_IFF.1 Simple Security Attributes

Hierarchical to: No other components

103 [selection: [assignment: parts of TSF data], TSF data]

104 assignment: list of types of failures in the TSF

105 [assignment: information flow control SFP]

106 [assignment: list of subjects, information, and operations that cause controlled information to flow to and from controlled subjects covered by the SFP]

Application Firmware of SSR for eID Verification System

Dependencies: FDP_IFC.1 Subset information flow control fulfilled by FDP_IFC.1

FMT_MSA.3 Static attribute initialization not fulfilled but justified

Justification: The initial value for IVM is defined in the TOE during manufacturing. For other information under Information Flow Control Policy, initial value is not required, nor meaningful.

FDP_IFF.1.1	<p>The TSF shall enforce the <i>Information Flow Control Policy</i>¹⁰⁷ based on the following types of subject and information security attributes: <i>Subjects</i>: SPCA (subject of TOE on SSR Type I and SSR Type II), SAS (subject for TOE on SSR Type II with SAS), APS (subject for TOE on SSR Type III), OCSP Server for TOE on SSR Type III, IVPS for SSR Type III.</p> <p><i>Information</i>: TOE Upgrade Package, IVA, IVM, OCSP response, SAM Secure Messaging CVC and SAM Role CVC</p> <p><i>Attributes</i>: Software Publisher Signature for TOE Upgrade Package, SAM Signature for IVA, IVP Signature for IVM, OCSP signature for OCSP response, eID management CA Signature correspondingly¹⁰⁸.</p>
FDP_IFF.1.2	<p>The TSF shall permit an information flow between a controlled subject and controlled information via a controlled operation if the following rules hold: IVA is sent only if communication channel with corresponding SPCA, SAS or APS is established as defined in this PP and other information under the control of Information Flow Control Policy are accepted and written if signature verification is completed successfully¹⁰⁹.</p>
FDP_IFF.1.3	<p>The TSF shall enforce the <i>none</i>¹¹⁰.</p>
FDP_IFF.1.4	<p>The TSF shall explicitly authorize an information flow based on the following rules: <i>none</i>¹¹¹.</p>
FDP_IFF.1.5	<p>The TSF shall explicitly deny an information flow based on the following rules: <i>none</i>¹¹².</p>

¹⁰⁷ [assignment: *information flow control SFP*]

¹⁰⁸ [assignment: *list of subjects and information controlled under the indicated SFP, and for each, the security attributes*]

¹⁰⁹ [assignment: *for each operation, the security attribute-based relationship that must hold between subject and information security attributes*]

¹¹⁰ [assignment: *additional information flow control SFP rules*]

¹¹¹ [assignment: *rules, based on security attributes, that explicitly authorize information flows*]

¹¹² [assignment: *rules, based on security attributes, that explicitly deny information flows*]

6.1.7.3 FDP_ETC.2 Export of User Data with Security Attributes

Hierarchical to: No other components

Dependencies: [FDP_ACC.1 Subset access control, or

FDP_IFC.1 Subset information flow control] fulfilled by FDP_IFC.1

FDP_ETC.2.1	The TSF shall enforce the <i>Information Flow Control Policy</i> ¹¹³ when exporting user data, controlled under the SFP(s), outside of the TOE.
FDP_ETC.2.2	The TSF shall export the user data with the user data's associated security attributes
FDP_ETC.2.3	The TSF shall ensure that the security attributes, when exported outside the TOE, are unambiguously associated with the exported user data.
FDP_ETC.2.4	The TSF shall enforce the following rules when user data is exported from the TOE: <i>none</i> ¹¹⁴ .

6.1.7.4 FDP_RIP.1 Subset residual information protection

Hierarchical to: No other components.

Dependencies: No dependencies.

FDP_RIP.1.1	The TSF shall ensure that any previous information content of a resource is made unavailable upon the <u>deallocation of the resource from</u> ¹¹⁵ the following objects <i>cryptographic credentials, IVA data fields, PIN, photo and biometric information</i> ¹¹⁶ .
-------------	--

6.1.8 CLASS FTP: TRUSTED PATH/CHANNELS

6.1.8.1 FTP_ITC.1 Inter-TSF trusted channel

Hierarchical to: No other components.

Dependencies: No dependencies.

FTP_ITC.1.1	The TSF shall provide a communication channel between itself and another trusted IT-product each one of the following trusted products: Role Holder Device, External Biometric Sensor (if applicable), External Pin Pad (if
-------------	---

113 [assignment: access control SFP(s) and/or information flow control SFP(s)]

114 [assignment: additional exportation control rules]

115 [selection: allocation of the resource to, deallocation of the resource from]

116 [assignment: list of objects]

Application Firmware of SSR for eID Verification System

	applicable), eID Card, SSR SAM, SAS for TOE on SSR Type II (with SAS) and APS for TOE on SSR Type III that is logically distinct from other communication channels and provides assured identification of its endpoints and protection of the channel data from modification or disclosure.
FTP_ITC.1.2	The TSF shall permit <u>the TSF</u> ¹¹⁷ to initiate communication via the trusted channel.
FTP_ITC.1.3	The TSF shall initiate communication via the trusted channel for <i>all functions</i> ¹¹⁸ .

Refinement: The role holder certificate used to construct the trusted channel shall be kept in the HSM device. External Biometric Sensor and the external Pin Pad shall include a Secure Access Module. Trusted paths with SSR Access Server and Application Server are founded using SSL-TLS using SSL- TLS certificates.

6.2 APPLICATION OF SFRS TO TOE ON DIFFERENT SSR TYPES AND BIOMETRIC SENSOR / EPP CONFIGURATIONS

The application of the SFRs to the TOEs on different SSR types and biometric sensor and EPP configurations and whether the device will run in offline mode or not are stated in Section 6.1 as Application Notes right after the corresponding SFRs. The relevant SFR corresponding to the Type of the SSR and other configurations should be chosen by the ST writer.

6.3 SECURITY ASSURANCE REQUIREMENTS

For the evaluation of the TOE and its development and operating environment are those taken from the Evaluation Assurance Level (EAL4) and augmented by taking the following component: ALC_DVS.2.

6.4 SECURITY REQUIREMENTS RATIONALE

6.4.1 SECURITY FUNCTIONAL REQUIREMENTS RATIONALE

OT.IVM_Management: FIA_UAU.5 selects the rules for authentication of Service Requester and Service Attendee. FMT_MOF.1/Verify restricts the use of the management function to the security

117[selection: the TSF, another trusted IT product]
118[assignment: list of functions for which a trusted channel is required]

Application Firmware of SSR for eID Verification System

role: Identity Verification Policy Server and SPCA. FMT_SMF.1 and FMT_SMR.1 determines the management functions and roles.

SFRs: FIA_UAU.5, FMT_MOF.1/Verify, FMT_SMF.1, and FMT_SMR.1.

OT.Security_Failure: This objective is covered by FPT_FLS. 1, FAU_GEN.1 and FAU_SAA.1 which requires preserving the secure state, auditing and taking the action of entering out of service mode respectively upon detection of a security failure.

SFRs: FPT_FLS.1, FAU_GEN.1 and FAU_SAA.1.

OT.eIDC_Authentication: Card authentication mechanism is covered by the FIA_UAU.5, FIA_UID.2 and FIA_UAU.2. FCS_COP.1/Sign_Ver verifies the authenticity of the certificate and FPT_IDA.1/X509 verifies the authenticity of the certificate. FPT_SSY/IVC addresses that the eID Card certificate is not expired. Generation of audit data when failure of authentication happens is provided by FAU_GEN.1.

SFR: FIA_UAU.5, FAU_GEN.1, FIA_UID.2, FCS_COP.1/Sign_Ver, FPT_IDA.1/X509, FPT_SSY/IVC and FIA_UAU.2.

OT.PIN_Verification: Identity Verification Certificate PIN verification is covered by the FIA_UAU.5, FIA_UAU.2 and FIA_UID.2 and protection of PIN during entry is addressed by the FIA_UAU.7. Generation of audit data when failure of authentication happens is provided by FAU_GEN.1.

SFRs: FIA_UAU.2, FIA_UID.2, FIA_UAU.5, FIA_UAU.7 and FAU_GEN.1

OT.Photo_Verification: Authentication needs for Photo verification is covered by the FIA_UAU.5, FIA_UAU.2 and FIA_UID.2. Generation of audit data when failure of authentication happens is provided by FAU_GEN.1.

SFRs: FIA_UAU.5, FAU_GEN.1, FIA_UAU.2 and FIA_UID.2.

OT.Biometric_Verification: Biometric verification is covered by the FIA_UAU.5. Generation of audit data when failure of authentication happens is provided by FAU_GEN.1. Authentication failure handling of biometric verification is handled by FIA_AFL.1. Protection of biometry data during entry is addressed by the FIA_UAU.7.

SFRs: FIA_UAU.5, FIA_AFL.1, FAU_GEN.1 and FIA_UAU.7.

OT_IVA_Signing: FAU_GEN.1 requires auditing the created IVAs. The FCO_NRO.2 guaranties the authentication of the IVA. The hash value of the IVA is created and signed in SAM. This requirement is covered by FCS_COP.1/SHA-256.

SFRs: FCO_NRO.2, FCS_COP.1/SHA-256

OT.IVA_Privacy: IVA is directly sent to APS in TOE on SSR Type III. Thus confidentiality of the IVA during transmission is covered by FCS_CKM.1/SM_TLS, FCS_CKM.4 and FTP_ITC.1.

The cryptographic requirement for IVA confidentiality for the TOE on SSR Type III in the offline mode is guaranteed by FDP_RIP, FCS_COP.1/AES-CBC and FCS_COP.1/AES-CMAC. The generation and

rev: 2.8	date: 01.08.2017	SSR_PP_2.8	90. page of	105pages
----------	------------------	------------	-------------	----------

Application Firmware of SSR for eID Verification System

destruction of the encryption/decryption keys are addressed by FCS_CKM.1/IVA_Keys and FCS_CKM.4. These keys are generated by SAM and stored in the tamper proof area. The confidentiality of this key is guaranteed by FCS_CKM.1/SM, FCS_CKM.4 and FPT_ITC.1 during transmission from SAM to TOE and by FAU_ARP.1 during storage. The stored IVA integrity for TOE on SSR Type III in offline mode is addressed by FDP_ETC.2, FDP_IFC.1 and FDP_IFF.1 define *Information Flow Control Policy* to sign IVA by SAM before sending it to IVS.

SFRs: FCS_COP.1/AES-CBC, FCS_COP.1/AES-CMAC, FAU_GEN.1, FAU_ARP.1, FCS_COP.1/SHA-256, FCS_CKM.1/SM, FCS_CKM.1/IVA_Keys, FCS_CKM.1/SM-TLS, FCS_CKM.4, FPT_ITC.1, FDP_RIP.1, FDP_ETC.2, FDP_IFC.1 and FDP_IFF.1.

OT.PM_Verification: Since only the legitimate TOE could found secure messaging with eID Card and read personal message FCS_CKM.1/SM, FCS_CKM.4, FCS_COP.1/AES-CBC and FCS_COP.1/AES-CMAC covers the OT.PM_Verification with FAU_GEN.1 which audits the confirmation of the personal message

SFR: FAU_GEN.1, FCS_CKM.1/SM, FCS_COP.1/AES-CBC, FCS_COP.1/AES-CMAC and FCS_CKM.4.

OT.SA_Identity_Verification: FIA_UID.2, FIA_UAU.2 and FIA_UAU.5 covers the identity verification of Service Attendee and FAU_GEN.1 requires the auditing of the authentication.

SFR: FIA_UID.2, FIA_UAU.2, FIA_UAU.5 and FAU_GEN.1

OT.Session_Ending: FIA_UAU.6 and FAU_GEN.1 covers the objective.

SFRs: FIA_UAU.6, FAU_GEN.1.

OT.ID_Verification_Policy_Authentication: FDP_ETC.2, FDP_IFC.1 and FDP_IFF.1 define *Information Flow Control Policy* for verifying the signature of the Identity Verification Policy sent by the IVPS. FPT_IDA.1/IVP covers the authentication of policy and FPT_IDA.1/X509 covers the authentication of the certificate of the policy server. The Identity Verification Policy Authentication mechanism addressed in the FPT_IDA.1/IVP and FPT_IDA.1/X509 require the cryptographic support of FCS_COP.1/ Sign_Ver. FAU_GEN.1 audits the authentication.

SFRs: FDP_ETC.2, FDP_IFC.1, FDP_IFF.1, FPT_IDA.1/IVP, FPT_IDA.1/X509, FCS_COP.1/ Sign_Ver and FAU_GEN.1.

OT.OCSP_Query_Verify: FDP_ETC.2, FDP_IFC.1 and FDP_IFF.1 define *Information Flow Control Policy* for verifying the signature of the OCSP Query Response sent by the OCSPS. FPT_IDA.1/OCSP covers the authentication of query response and FPT_IDA.1/X509 covers the authentication of the certificate of the OCSP server. The OCSP Query Response Verification Mechanism addressed in the FPT_IDA.1/OCSP requires the cryptographic support of FCS_COP.1/ Sign_Ver. FAU_GEN.1 audits the authentication.

Application Firmware of SSR for eID Verification System

SFRs: FDP_ETC.2, FDP_IFC.1, FDP_IFF.1, FPT_IDA.1/OCSP, FPT_IDA.1/X509, FCS_COP.1/ Sign_Ver and FAU_GEN.1.

OT.RH_DA [Role Holder Device Authentication]: FIA_UAU.5 and FPT_IDA.1/CVC covers the authentication of role holder and role holder CVC certificate. This requires the cryptographic support of FCS_COP.1/ Sign_Ver. FAU_GEN.1 audits the authentication.

SFR: FIA_UAU.5, FPT_IDA.1/CVC, FCS_COP.1/ Sign_Ver and FAU_GEN.1.

OT.RH_SC [Secure Communication with Role Holder]: FTP_ITC.1 covers the secure communication between the Role Holder and the TOE. FCS_CKM.1/SM, FCS_CKM.4, FCS_COP.1/AES-CBC, FCS_COP.1/AES-CMAC give the necessary cryptographic support for the secure communication.

SFRs: FTP_ITC.1, FCS_CKM.1/SM, FCS_CKM.4, FCS_COP.1/AES-CBC, FCS_COP.1/AES-CMAC.

OT.RH_Session_Ending: FPT_SSY.1/RH_Auth_Status covers the objective.

SFR: FPT_SSY.1/RH_Auth_Status

OT.EBS_DA: FIA_UID.2, FIA_UAU.2 and FIA_UAU.5 covers the identity verification of EBS, FPT_SSY/IVC addresses that the EBS SAM certificate is not expired and FAU_GEN.1 requires the auditing of the authentication.

SFR: FIA_UID.2, FIA_UAU.2, FIA_UAU.5, FPT_SSY/IVC and FAU_GEN.1

OT.EBS_SC: FTP_ITC.1 covers the secure communication between the EBS and the TOE. FCS_CKM.1/SM, FCS_CKM.4, FCS_COP.1/AES-256, FCS_COP.1/AES-CMAC give the necessary cryptographic support for the secure communication.

SFRs: FTP_ITC.1, FCS_CKM.1/SM, FCS_CKM.4, FCS_COP.1/AES-CBC, FCS_COP.1/AES-CMAC.

OT.EPP_DA [External PIN-PAD Device Authentication]: FIA_UID.2, FIA_UAU.2 and FIA_UAU.5 covers the identity verification of EPP, FPT_SSY/IVC addresses that the EPP SAM certificate is not expired and FAU_GEN.1 requires the auditing of the authentication.

SFR: FIA_UID.2, FIA_UAU.2, FIA_UAU.5, FPT_SSY/IVC and FAU_GEN.1

OT.EPP_SC: FTP_ITC.1 covers the secure communication between the EPP and the TOE. FCS_CKM.1/SM, FCS_CKM.4, FCS_COP.1/AES-CBC, FCS_COP.1/AES-CMAC give the necessary cryptographic support for the secure communication.

SFRs: FTP_ITC.1, FCS_CKM.1/SM, FCS_CKM.4, FCS_COP.1/AES-CBC, FCS_COP.1/AES-CMAC.

OT.SM_eID Card: FTP_ITC.1 and FPT_IDA.1/CVC covers the secure communication between the eID Card and the TOE. FCS_CKM.1/SM, FCS_CKM.4, FCS_COP.1/AES-CBC, FCS_COP.1/AES-CMAC give the necessary cryptographic support for the secure communication.

SFRs: FTP_ITC.1, FPT_IDA.1/CVC, FCS_CKM.1/SM, FCS_CKM.4, FCS_COP.1/AES-CBC, FCS_COP.1/AES-CMAC

rev: 2.8	date: 01.08.2017	SSR_PP_2.8	92. page of	105pages
----------	------------------	------------	-------------	----------

Application Firmware of SSR for eID Verification System

OT.DPM: FMT_SMF and FMT_SMR cover the phase management functions and roles thus covers the objective.

SFRs: FMT_SMF.1 and FMT_SMR.1.

OT.TOE_Upgrade: The management function and roles of TOE upgrade is addressed by FMT_SMF.1 and FMT_SMR.1. Unauthorized TOE Update is protected by FMT_MOF.1/Upgrade_Management and FPT_IDA.1/TOE_Upgrade. FPT_IDA.1/X509 covers the authentication of the certificate of the software publisher server. FDP_ETC.2, FDP_IFC.1 and FDP_IFF.1 define *Information Flow Control Policy* for verifying the signature of the Upgrade Package sent by the Software Publisher. The authentication before the upgrade is guaranteed by the FIA_UAU.2 and FIA_UID.2. Required cryptographic support is covered by FCS_COP.1/SHA-256, FCS_COP.1/AES-CBC and FCS_COP.1/Sign_Ver. Audit generation is needed thus FAU_GEN.1 is covered.

SFRs: FAU_GEN.1, FMT_SMF.1, FMT_SMR.1, FMT_MOF.1/Upgrade_Management, FPT_IDA.1/TOE_Upgrade, FPT_IDA.1/X509, FCS_COP.1/SHA-256, FCS_COP.1/AES-CBC, FCS_COP.1/Sign_Ver FIA_UAU.2 and FIA_UID.2, FDP_IFC.1, FDP_IFF.1, FDP_ETC.2.

OT.SAM-PIN_Mgmt: The management function of writing the SAM-PIN is addressed by FMT_SMF.1; and protection of SAM-PIN from unauthorized access is provided by FMT_MTD.1/SAM-PIN. FMT_SMR.1 addresses the security role Initialization Agent who is allowed to write the SAM-PIN.

SFRs: FMT_MTD.1/SAM-PIN, FMT_SMF.1, FMT_SMR.1

OT.DTN_Mgmt: The device tracking number can only written by the configuration agent; this requirement is covered by FMT_MTD.1/DTN. Relevant management function and role are covered by FMT_SMF.1 and FMT_SMR.1. Authentication of the role before DTN writing is covered by FIA_UAU.2 and FIA_UID.2.

SFRs: FMT_MTD.1/DTN, FMT_SMF.1, FMT_SMR.1, FIA_UAU.2 and FIA_UID.2.

OT.Time_Mgmt: Time data may only be updated by the security role(s) defined by the ST writer. This is addressed by FMT_MTD.1/Time. Security role and management function regarding the writing the Default Method is given in the SFRs: FMT_SMR.1 and FMT_SMF.1. Authentication of the role before time update is covered by FIA_UAU.2 and FIA_UID.2. Providing the real time for IVA data and audit data is fulfilled by FPT_STM.1.

SFRs: FMT_MTD.1/Time, FMT_SMF.1, FMT_SMR.1, FIA_UAU.2, FIA_UID.2 and FPT_STM.1.

OT.SM_TOE_and_SAM [Security between TOE and SAM]: FTP_ITC.1 covers the secure communication between the TOE and the SAM. The necessary cryptographic support is given by FCS_CKM.1/SM, FCS_CKM.4, FCS_COP.1/RSA, FCS_COP.1/AES-CBC, and FCS_COP.1/AES-CMAC.

SFRs: FTP_ITC.1, FCS_CKM.1/SM, FCS_CKM.4, FCS_COP.1/RSA, FCS_COP.1/AES-CBC, FCS_COP.1/AES-CMAC

rev: 2.8	date: 01.08.2017	SSR_PP_2.8	93. page of	105pages
----------	------------------	------------	-------------	----------

Application Firmware of SSR for eID Verification System

OT.SAM-PIN_Sec: The security of the SAM-PIN is satisfied by the deletion of the SAM PIN upon detection of a tamper event. This objective is covered by FPT_FLS.1, FAU_GEN.1 and FAU_ARP.1

SFRs: FPT_FLS.1, FAU_GEN.1 and FAU_ARP.1.

OT.DTN_Integrity: The objective OT.DTN_Integrity is provided by FPT_TST.1 and FPT_FLS.1.

SFR: FPT_TST.1 and FPT_FLS.1.

OT.Audit_Data_Protection : FAU_STG1, FAU_SAR.1 and FAU_STG.4 covers the audit data protection.

SFR: FAU_STG1, FAU_SAR.1 and FAU_STG.4

OT.RIP [Residual Information Protection]: The SFR FDP_RIP.1 provides the protection aimed by OT.RIP.

SFR: FDP_RIP.1

OT.Auth_SAM_by_TOE [Authentication of SAM by TOE]: FIA_UAU.5 addresses the authentication of SAM by the TOE. FPT_SSY.1/SAM addresses the revocation status control.

SFRs: FIA_UAU.5, FPT_SSY.1/SAM.

OT.SAS_DA: FIA_UID.2, FIA_UAU.2 and FIA_UAU.5 covers the objective of device authentication of SAS with FAU_GEN.1

SFRs: FIA_UID.2, FIA_UAU.2, FIA_UAU.5, FAU_GEN.1

OT.SAS_SC: FCS_CKM.1/SM_TLS, FCS_COP.1/AES-CBC, FCS_COP.1/SHA-256 and FTP_ITC.1 covers the objective

SFRs: FCS_CKM.1/SM_TLS and FTP_ITC.1

OT.APS_DA: FIA_UID.2, FIA_UAU.2, FIA_UAU.6, and FIA_UAU.5 covers the objective of device authentication of SAS with FAU_GEN.1

SFRs: FIA_UID.2, FIA_UAU.2, FIA_UAU.5, FAU_GEN.1

OT.APS_SC: FCS_CKM.1/SM_TLS, FCS_COP.1/AES-CBC, FCS_COP.1/SHA-256 and FTP_ITC.1 covers the objective.

SFRs: FCS_CKM.1/SM_TLS and FTP_ITC.1

OT.Cert_Update: Validity of certificates needs to be checked by the TOE. This is covered by FPT_SSY.1/Cert. During certificate update, the integrity and authenticity of the new certificates replacing the old certificates are ensured. For this, FDP_ETC.2, FDP_IFC.1 and FDP_IFF.1 define *Information Flow Control Policy* for verifying *eID management CA signature*.

SFRs: FPT_SSY.1/Cert, FDP_ETC.2, FDP_IFC.1, and FDP_IFF.1

6.4.2 SECURITY FUNCTIONAL REQUIREMENTS RATIONALE TABLES

The coverage of objectives by the SFRs are given in Table19, Table20 and Table21.

Table19 given below includes the objectives for the SSR Type I without Biometric Sensor and External PIN PAD, that are also valid for TOE on all of the three SSR Types where external PIN Pad and External/Internal Biometric Sensor is not present.

Table19. SFR Rationale Table for TOE on SSR Type I without Biometric Sensor and External PIN Pad

SFR s	OT.IVM_Management	OT.Security_Failure	OT.eIDC_Authentication	OT.PIN_Verification	OT.IVA_Signing	OT.PM_Verification	OT.ID_Verification Policy_Authentication	OT.OCSP_Query_Verify	OT.RH_DA	OT.RH_SC	OT.RH_Session_Ending	OT.SM_eID Card	OT.DPM	OT.TOE_Upgrade	OT.SAM-PIN_Mgmt	OT.DTN_Mgmt	OT.Time_Mgmt	OT.SM_TOE_and_SAM	OT.SAM-PIN_Sec	OT.DTN_Integrity	OT.Audit_Data_Protection	OT.RIP	OT.Auth_SAM_by_TOE	OT.Cert_Update
FAU_GEN.1		✓	✓	✓		✓	✓	✓	✓					✓					✓					
FAU_ARP.1																			✓					
FAU_SAR.1																					✓			
FAU_STG.1																					✓			
FAU_STG.4																					✓			
FAU_SAA.1		✓																						
FCS_CKM.1/SM						✓				✓		✓						✓						
FCS_CKM.1/SM_TLS																								

Application Firmware of SSR for eID Verification System

SFR s	OT.IVM_Management	OT.Security_Failure	OT.eIDC_Authentication	OT.PIN_Verification	OT.IVA_Signing	OT.PM_Verification	OT.ID_Verification Policy_Authentication	OT.OCSP_Query_Verify	OT.RH_DA	OT.RH_SC	OT.RH_Session_Ending	OT.SM_eID Card	OT.DPM	OT.TOE_Upgrade	OT.SAM-PIN_Mgmt	OT.DTN_Mgmt	OT.Time_Mgmt	OT.SM_TOE_and_SAM	OT.SAM-PIN_Sec	OT.DTN_Integrity	OT.Audit_Data_Protection	OT.RIP	OT.Auth_SAM_by_TOE	OT.Cert_Update
FCS_CKM.1/IVA_Keys																								
FCS_CKM.4						✓				✓		✓						✓						
FCS_COP.1/SHA-256					✓									✓										
FCS_COP.1/AES-CBC						✓				✓		✓		✓				✓						
FCS_COP.1/AES-CMAC						✓				✓		✓						✓						
FCS_COP.1/RSA																		✓						
FCS_COP.1/ Sign_Ver			✓				✓	✓	✓					✓										
FIA_UID.2			✓	✓										✓		✓	✓							
FIA_UAU.2			✓	✓										✓		✓	✓							
FIA_UAU.5	✓		✓	✓					✓														✓	
FIA_UAU.7				✓																				
FCO_NRO.2					✓																			
FMT_MOF.1/Verify	✓																							
FMT_MOF.1/Upgrade_Management														✓										
FMT_MTD.1/SAM-PIN															✓									

Application Firmware of SSR for eID Verification System

SFR s	OT.IVM_Management	OT.Security_Failure	OT.eIDC_Authentication	OT.PIN_Verification	OT.IVA_Signing	OT.PM_Verification	OT.ID_Verification Policy_Authentication	OT.OCSP_Query_Verify	OT.RH_DA	OT.RH_SC	OT.RH_Session_Ending	OT.SM_eID Card	OT.DPM	OT.TOE_Upgrade	OT.SAM-PIN_Mgmt	OT.DTN_Mgmt	OT.Time_Mgmt	OT.SM_TOE_and_SAM	OT.SAM-PIN_Sec	OT.DTN_Integrity	OT.Audit_Data_Protection	OT.RIP	OT.Auth_SAM_by_TOE	OT.Cert_Update
FMT_MTD.1/DTN																✓								
FMT_MTD.1/Time																	✓							
FMT_SMF.1	✓												✓	✓	✓	✓	✓							
FMT_SMR.1	✓												✓	✓	✓	✓	✓							
FPT_STM.1																	✓							
FPT_IDA.1/CVC									✓			✓												
FPT_IDA.1/X509							✓	✓						✓										
FPT_IDA.1/IVP							✓																	
FPT_IDA.1/OCSP								✓																
FPT_IDA.1/TOE_Upgrade														✓										
FPT_SSY.1/IVC			✓																					
FPT_SSY.1/SAM																							✓	
FPT_SSY.1/RH_Auth_Status											✓													
FPT_TST.1																				✓				
FDP_RIP.1																						✓		
FPT_FLS.1		✓																	✓	✓				

Application Firmware of SSR for eID Verification System

SFR s	OT.IVM_Management	OT.Security_Failure	OT.eIDC_Authentication	OT.PIN_Verification	OT.IVA_Signing	OT.PM_Verification	OT.ID_Verification Policy_Authentication	OT.OCSP_Query_Verify	OT.RH_DA	OT.RH_SC	OT.RH_Session_Ending	OT.SM_eID Card	OT.DPM	OT.TOE_Upgrade	OT.SAM-PIN_Mgmt	OT.DTN_Mgmt	OT.Time_Mgmt	OT.SM_TOE_and_SAM	OT.SAM-PIN_Sec	OT.DTN_Integrity	OT.Audit_Data_Protection	OT.RIP	OT.Auth_SAM_by_TOE	OT.Cert_Update
FTP_ITC.1										✓		✓						✓						
FPT_SSY.1/Cert																								✓
FDP_ETC.2							✓	✓						✓										✓
FDP_IFC.1							✓	✓						✓										✓
FDP_IFF.1							✓	✓						✓										✓

Application Firmware of SSR for eID Verification System

Table20 gives the SFR Rational for additional objectives of TOE on SSR Type II and SSR Type III.

Table20: SFR Rationale for additional objectives of TOE on SSR Type II and SSR Type III

	OT.Photo_Verification	OT.SA_Identity_Verification	OT.Session_Ending	OT.SAS_DA	OT.SAS_SC	OT.APS_DA	OT.APS_SC
FAU_GEN.1	✓	✓	✓	✓		✓	
FCS_CKM.1/SM_TLS					✓		✓
FCS_COP.1/SHA-256					✓		✓
FCS_COP.1/AES-CBC					✓		✓
FIA_UID.2	✓	✓		✓		✓	
FIA_UAU.2	✓	✓		✓		✓	
FIA_UAU.5	✓	✓		✓		✓	
FIA_UAU.6			✓			✓	
FTP_ITC.1					✓		✓

Table21 gives the SFR Rational for additional objectives of TOE on SSR with biometric sensor and/or external PIN PAD.

Table21: SFR rationale additions for TOE on SSR with External/Internal Biometric Sensor and/or

EPP

	OT.Biometric_Verification	OT.EPP_DA	OT.EPP_SC	OT.EBS_DA	OT.EBS_SC	OT.Session_Ending
FAU_GEN.1	✓	✓		✓		
FIA_AFL.1	✓					
FIA_UID.2		✓		✓		
FIA_UAU.2		✓		✓		
FIA_UAU.5	✓	✓		✓		

Application Firmware of SSR for eID Verification System

FIA_UAU.6						✓
FIA_UAU.7	✓					
FCS_CKM.1/SM			✓		✓	
FCS_CKM.4			✓		✓	
FCS_COP.1/AES-CBC			✓		✓	
FCS_COP.1/AES-CMAC			✓		✓	
FPT_SSY.1/IVC		✓		✓		
FTP_ITC.1			✓		✓	

Table22: SFR Rationale for additional objectives of TOE on SSR Type III

SFR s	OT.IVA_Privacy
FAU_GEN.1	✓
FAU_ARP.1	✓
FCS_CKM.1/SM	✓
FCS_CKM.1/SM_TLS	✓
FCS_CKM.1/IVA_Keys	✓
FCS_CKM.4	✓
FCS_COP.1/AES-CBC	✓
FCS_COP.1/AES-CMAC	✓
FDP_RIP.1	✓
FTP_ITC.1	✓
FDP_ETC.2	✓
FDP_IFC.1	✓
FDP_IFF.1	✓

6.4.3 SECURITY ASSURANCE REQUIREMENTS RATIONALE

EAL4 is chosen to permit a developer to gain maximum assurance from positive security engineering based on good commercial development practices which, though rigorous, do not require substantial specialist knowledge, skills, and other resources. EAL4 is the highest level at which it is likely to be economically feasible to retrofit to an existing product line.

EAL4 is applicable in those circumstances where developers or users require a moderate to high level of independently assured security in conventional commodity TOEs and are prepared to incur additional security-specific engineering costs.

The selection of the component ALC_DVS.2 provides a higher assurance of the security of the TOE's development and manufacturing especially for the secure handling of the TOE's material.

The component ALC_DVS.2 augmented to EAL4 has no dependencies to other security requirements.

7 GLOSSARY AND ACRONYMS

7.1 GLOSSARY

Service Provider Environment:

SCPA (Service Provider Client Application): The external system that requests the identity verification. The SCPA may directly state the method that will be used in the identity verification process or may state the method will be declared by the IVPS. And as a final option the SCPA may state that the default method stored in the TOE should be used in the identity verification process.

IVPS (Identity Verification Policy Server): The external system that prepares the Identity Verification Policy (Identity Verification Policy) and sends it to the TOE. The TOE performs the identity verification method defined in the policy.

IVS (Identity Verification Server): The external entity that validates the IVAs created by the TOE.

Identity Verification Environment:

eID Card (Electronic Identity Card): The identity card used by service requester for claiming and proving his or her identity.

SR (Service Requester): Service requester is the person who claims and proves his or her identity. The service requester claim starts with presenting eID Card to the SSR. The TOE, the SAM and the Service Attendee¹¹⁹ together verify the claim interacting with the Service Requester and the eID Card¹²⁰.

SA (Service Attendee): Service Attendee is the person who attends the identity verification process and approves if the photo displayed by the SSR belongs to the service requester. Service Attendee is also subject to prove his or her identity one of the methods.

OCSPS (Online Certificate Status Protocol Server): The server that keeps the revocation status of the IVCs. The OCSPS responds to the OSCP queries with the revocation status of the queried IVC.

Malicious Actors and Malicious External Systems:

Identity Faker: The attacker who tries to masquerade his or her identity with someone else's identity.

Illegitimate eID Card: An identity faker may use three types of illegitimate eID Card: a counterfeit eID Card, a forged eID Card and a revoked eID Card.

The Proxy Entities:

¹¹⁹The Service Attendee's presence and role depends on the Configuration of the TOE and the selected identity verification method.

¹²⁰PIN Verification involves interaction of Service Requester with eIDC.

Application Firmware of SSR for eID Verification System

PC (Personal Computer): The computer the UIS or NIS is running on.

SSR Environment:

SAM (Secure Access Module): The SAM is the secure element of the SSR. The critical security functionality of the SSR is performed by the SAM. Since the TOE is the application software of the SSR, the SAM is an external element. The TOE accesses the SAM services through PIN verification.

The SSR Platform: The SAM and the SSR Environment are the non-TOE hardware, software, firmware and the physical protection that the TOE needs to function. The SSR environment at minimum consists of USB Interface, the smart card interfaces, graphic display, Service Requester interface, real time clock, execution environment and operating system. Optionally depending on the configuration, the TOE may have Service Attendee interface, biometric sensor, Ethernet interface and interfaces for EBS and EPP. The SSR platform should also include security features to protect itself from tampering.

EBS¹²¹ (External Biometric Sensor): Optional external entity connected to the TOE. Depending on the sensor type, it sends the biometric template or biometric verification result to the TOE.

EPP¹²² (External PIN-PAD): Optional external entity connected to the TOE. The EPP is present only for TOE of Configuration Type III. External PIN_PAD offers convenience to the Service Requester. When external PIN-PAD is available, the Service Requester inserts his or her eID Card and enters IVC-PIN to external PIN-PAD.

7.2 ACRONYMS

APS: Application Server

CRL: Certificate Revocation List

CVC: Card Verifiable Certificate

DA: Device Authentication

DTN: Device Tracking Number

EBS: External Biometric Sensor

eID: Electronic Identity

EPP: External pin Pad

eIDMS: Electronic Identity Management System

eID Card: Electronic Identity Card

eIDVS: Electronic Identity Verification System

eSign: Electronic Signature

¹²¹EBS presence depends on the SSR configuration.

¹²²EPP presence depends on the SSR configuration.

Application Firmware of SSR for eID Verification System

IV: Identity Verification

IVA: Identity Verification Assertion

IVC: Identity Verification Certificate

Identity Verification Policy: Identity Verification Policy

IVPS: Identity Verification Policy Server

IVR: Identity Verification Request

IVS: Identity Verification Server

IVSP: Identity Verification Specification

OCSPS: Online Certificate Status Protocol Server

SAM: Security Access Module

SAS: SSR Access Server

SPCA: Service Provider Client Application

SPSA: Service Provider Server Application

SSR: Card Acceptance Device

TA: Terminal Authentication

7.3 REFERENCES

1. TS 13582 - Elektronik Kimlik Kartları İçin Güvenli Kart Erişim Cihazları Standardı – Bölüm-1: Genel Bakış, (Secure Smart Card Reader Standard - Part-1: Overview) 2013, Türk Standartları Enstitüsü
2. TS 13583 - Elektronik Kimlik Kartları İçin Güvenli Kart Erişim Cihazları Standardı – Bölüm-2: Arayüzler ve Özellikleri, (Secure Smart Card Reader Standard - Part-2: Interfaces and their characteristics) 2013, Türk Standartları Enstitüsü
3. TS 13584 - Elektronik Kimlik Kartları İçin Güvenli Kart Erişim Cihazları Standardı - Bölüm-3: Güvenlik Özellikleri (Secure Smart Card Reader Standard - Part-3: Security Properties), 2013, Türk Standartları Enstitüsü.
4. TS 13585 - Elektronik Kimlik Kartları İçin Güvenli Kart Erişim Cihazları Standardı - Bölüm-4: SSR Uygulama Yazılımı Özellikleri, (Secure Smart Card Reader Standard - Part-4: Secure Smart Card Reader Application Firmware Specifications), 2013, Türk Standartları Enstitüsü.
5. FIPS 180-4, Secure Hash Standard (SHS), March 2012, U.S. Department of Commerce, National Institute of Standards and Technology
6. FIPS 197, Advanced Encryption Standard (AES), November 2001, National Institute of Standards and Technology

rev: 2.8	date: 01.08.2017	SSR_PP_2.8	104. page of	105pages
----------	------------------	------------	--------------	----------

Application Firmware of SSR for eID Verification System

7. Recommendation for Block Cipher Modes of Operation, National Institute of Standards and Technology Special Publication 800-38A 2001 ED Natl. Inst. Stand. Technol. Spec. Publ. 800-38A 2001 ED, 66 pages (December 2001)
8. NIST Special Publications 800-38A, Recommendation for Block Cipher Modes of Operations, <http://csrc.nist.gov/publications/nistpubs/800-38a/sp800-38a.pdf>, 2001.
9. RFC 4493, The ESP CBC-Mode Cipher Algorithms, <https://tools.ietf.org/html/rfc4493>, June 2006, Internet Society Network Working Group.
10. PKCS #1 v2.1, RSA Cryptography Standard, September 2012, RSA Laboratories.
11. RFC 3447, RSA Cryptography Specifications, <https://www.ietf.org/rfc/rfc3447.txt>, Feb 2003, Internet Society Network Working Group.
12. ETSI TS 102 853, Electronic Signatures and Infrastructures (ESI); Signature verification procedures and policies, V1.1.1, July 2012.
13. TS 13678 Elektronik Kimlik Doğrulama Sistemi - bölüm 1: Genel Bakış
14. TS 13679 Elektronik Kimlik Doğrulama Sistemi - Bölüm 2: Kimlik Doğrulama Sunucusu
15. TS 13680 Elektronik Kimlik Doğrulama Sistemi - Bölüm 3: Kimlik Doğrulama Politika Sunucusu
16. TS 13681 Elektronik Kimlik Doğrulama Sistemi - Bölüm 4: Kimlik Doğrulama Yöntemleri
17. Common Criteria for Information Technology Security Evaluation Part I: Introduction and General Model; Version 3.1 Revision 4 CCMB-2012-09-001
18. Common Criteria for Information Technology Security Evaluation Part II: Security Functional Requirements; Version 3.1 Revision 4 CCMB-2012-09-002
19. Common Criteria for Information Technology Security Evaluation Part III: Security Assurance Requirements; Version 3.1 Revision 4 CCMB-2012-09-003
20. Common Criteria for Information Technology Security Evaluation, Evaluation Methodology; Version 3.1, Revision 4, CCMB-2012-09-004